

ROLTEC el-kørestole A/S

User Manual

User Manual for

ROLTEC Viper

Category B wheelchair

(FWD) Viper_USERMANUAL v1.5.2 UK





Preface

ROLTEC el-kørestole A/S would like to congratulate you on the purchase of your new wheelchair and thank you for the trust you have placed in us in choosing our product. Models may vary, therefore not everything will necessarily apply to your wheelchair.



ALWAYS READ THE USER MANUAL BEFORE USING THE WHEELCHAIR.

 The first time the wheelchair is used, it should be in an area with plenty of space and no traffic, starting at a low speed.

 Children and young people should read the documentation for the wheelchair with an adult before using it for the first time.

In this user manual you will find all the information you need to be able to operate the wheelchair. If you have any questions that are not clarified in this user manual, you are always welcome to contact your ROLTEC dealer.

If you find that the font size in the printed version of the user manual is difficult to read, the user manual is available in large font in an electronic version of this manual and is available from ROLTEC upon request. You can enlarge the PDF file on the screen using the zoom function.

Intended use/INDICATIONS

ROLTEC's electric wheelchairs are designed for people who have a partial or full walking disability, but whose sight, physical and mental capacity enables them to use an electric wheelchair.

Contraindications

There are no known contraindications.

(FWD) ROLTEC Viper

Category B

User manual: Viper_USERMANUAL v1.5.2 UK

Article number: Viper_USERMANUAL v1.5.2 UK







Produced and issued by ROLTEC A/S

IMPORTANT INFORMATION ABOUT THIS INSTRUCTION MANUAL



Note:

The following symbols will be used throughout this user manual to indicate elements that are crucial for safety.

 <p>Exercise extreme caution when this symbol is shown. Failure to do so may lead to personal injury and material damage, including damage to the wheelchair.</p>	 <p>Exercise caution when this symbol is shown.</p>	 <p>Do not ride in the chair when this symbol is shown.</p>
 <p>Read the user manual and the enclosed documentation</p>	 <p>This product complies with EU Directive 93/42/EEC for medical devices</p>	 <p>Manufacturer</p>

ROLTEC contact Info:



ROLTEC el-kørestole A/S
Lægårdsvej 13
DK - 8520 Lystrup.
Telephone +45 87 43 49 00
Fax +45 87 43 49 29
E-mail: Info@roltec.com

Table of Contents

Preface	2
Intended use/INDICATIONS	2
Contraindications.....	2
IMPORTANT INFORMATION ABOUT THIS INSTRUCTION MANUAL.....	3
ROLTEC contact Info:.....	3
Product approval.....	7
Check before running.....	7
Inspection:.....	7
Daily inspection:.....	7
Weekly check	7
Monthly check.....	8
Annual check.....	8
Warranty:	8
SAFETY INSTRUCTIONS.....	9
General.....	9
Component list.....	13
Using the PG R network.	14
General advice on wheelchair control:	14
Speed:	14
Drive profile:	15
Settings menu:	15
Set time - Adjusting the time:	15
Backlight:.....	16
Background:	16
Battery indicator:	16
Locking the joystick:.....	16
CJSM:.....	17
CJSM2:.....	19
JSM:.....	20
Swivel bracket.....	23
Charging:	24
The chair's mechanical settings	25
Seat depth.....	25

Back height	25
Chair back height.....	26
Adjusting the foot support	27
Adjusting the calf support	27
Angle of the foot plate	28
Adjusting the length of the leg support	29
Armrest.....	30
Armrest height.....	30
Armrest cushions.....	31
Transferring to and from the wheelchair.....	32
Headrest.....	33
Adjustment of the headrest.....	33
Suspension/Shock-absorber.....	33
Adjusting the suspension.....	33
External control box:	34
Transport of the chair.....	34
Loading/unloading.....	34
Securing during transportation	34
Transportation as freight:.....	34
Transportation by car:	34
Securing the wheelchair with a strap system.....	35
Angles for tie-down straps	36
Mounting of Dahl docking locking plate underneath the wheelchair.....	39
Description of function for Dahl Docking System	41
Release from the docking station.....	42
Manual release in the event of an electrical fault.....	42
Mounting the Dahl Docking System in the vehicle	43
Positioning belts:	44
Push function.....	45
Brakes.....	46
Lights and reflectors	46
Access to the battery room	47
Access to the batteries	49
Batteries:	49

Tyres:.....	49
Flywheel:.....	50
Drive wheel:.....	50
Disposal of the wheelchair:.....	51
Cleaning:.....	51
Disinfection:.....	51
Recycling:.....	51
Fuse:.....	52
Storage.....	52
Troubleshooting:.....	53
CJSM:.....	53
CJSM2:.....	54
JSM:.....	55
PRE-SALE INFORMATION.....	57
Data:.....	58
Measurements:.....	58
Weight:.....	58
Temperature range:.....	58
Explanation of labels/stickers on electric wheelchair.....	60
Spare parts and accessories.....	61
Components that are included in the supply.....	61

Product approval

This product meets the requirements of standard EN 12184:2014
The chair is crash-tested in accordance with ISO 10542-5 & 7176-19 – 2008

Check before running

- ! The following should be checked before running:
- ! The battery's charge status
- ! Set at the required speed

 Turn off the control box before getting in and out

Users are advised that changes made to the control parameters and other settings by the user or other unauthorised personnel are done so at their own risk!

- ! Always let the dealer carry out adjustments and settings

Inspection:

Daily inspection:

 It is extremely important to check the chair for damage on a daily basis. Pay particular attention to visible breakages in cables and defects in the rubber bellows on the joystick.

 If the damage mentioned above is present, the wheelchair should not be used, and driving it is at your own risk!

 If you find that the wheelchair and its accessories are not working as expected, or if there are unusual noises or a suspected defect, contact your wheelchair supplier as soon as possible.

Weekly check

Parking brake: This test should be carried out on an even surface, with at least one metre's clearance around the wheelchair.

1. Power up the wheelchair.
Check that the wheelchair remains switched on after initialisation and that the battery indicator shows a sufficient battery level.
2. Push the joystick slowly forwards, until you hear that the parking brakes are activated. The wheelchair will now start to run slowly.

3. Release the joystick. You should now be able to hear both parking brakes being activated within a couple of seconds, and the chair braking.

Repeat the test three more times.

Push the joystick slowly backwards, to the left and to the right.

Connectors and cables: Check that the cables and connector are arranged neatly and not damaged.

Joystick rubber seal: Check that the rubber around the control stick is not damaged or torn, so that no water or foreign bodies are able to penetrate.

Joystick mounting: Check that the control box and fittings are mounted properly and are not loose. Do not over-tighten any screws

Monthly check

- ! Check the air pressure in the wheels at least once a month.

Annual check

! We recommend that the chair is sent for servicing once a year by an authorised ROLTEC dealer in the country in which it was purchased. Contact your dealer if there are any problems or if a solution is not described in this user manual.

If your chair is equipped with an electrically adjustable back rest, this should be checked once a year. Moving parts should be lubricated and checked for wear. All visible bolts should be re-tightened.

! Power consumption increases significantly if there is not enough air in the tyres. Different pressure in the tyres will result in uneven running

Warranty:

The warranty is invalidated if the user has not carried out regular maintenance of the wheelchair, and the warranty will also be invalidated if the user has undertaken, or allowed a third party to undertake, repairs, mounting or modifications without ROLTEC's prior written consent. Nor does the warranty cover defects or damage caused by incorrect usage or storage of the wheelchair. The warranty will also be invalidated if the wheelchair is used in a manner or for a purpose for which it is inherently not suitable.

SAFETY INSTRUCTIONS

General



If the height is changed using force, with the seat raised or tipped, there is a risk of the chair overturning. In such case, to minimise this risk, it is important that the seat is raised as little as possible, and is in a horizontal position with the chair back as upright as possible.



Driving on surfaces that slope to one side should be avoided, as the tilting may increase the risk of the chair overturning. When the chair is used on uneven surfaces, the seat should not be raised, to ensure the chair's stability.



Avoid touching leaking batteries, as the contents are corrosive and can be harmful to your health.



ROLTEC el-kørestole A/S is exempt from all liability for any accidents caused through negligence, nor can ROLTEC el-kørestole A/S be held liable for the personal injuries or material damage that may arise if the user or other person has not followed the recommendations, warnings and instructions that are given in this user manual. You should therefore read the instructions for use thoroughly. It contains important warnings and instructions.



Increased risk of overturning if lift, tilt and electric back are used.



ROLTEC Viper is approved for a user weight of 130 kg.



You should always switch off the wheelchair when getting in or out of the chair - also when you are being assisted by an attendant, so that the chair does not start to roll if the joystick is inadvertently activated.



When the control box is swung out to the side or into place, there may be a risk of getting caught on the swivel bracket. Take care not to get your own or anyone else's fingers caught.



The wheelchair is EMC-tested. However, this does rule out the possibility of the wheelchair being affected by electro-magnetic fields, from mobile phones, for example. For this reason, transportable transmission, receiving and communications devices should not be used or switched on when the wheelchair is switched on. Should the wheelchair be started up unintentionally, or if the brakes fail, the wheelchair must be switched off immediately. Note that this does not rule out the possibility of the chair emitting electromagnetic fields, which may affect the surroundings, for example, office alarm systems.



Warning; the chair's electronics may cause so much electromagnetic interference that store alarms, for example, and electric gates in the immediate vicinity of the wheelchair can be affected.



Exercise particular care when driving down ramps.



When the chair's brakes are released, the chair may start to roll if it is standing on a sloping surface.



When braking (emergency braking) by pressing the On/Off button, the user's upper body can fall forwards and, in extreme cases, this may result in the user falling out of the chair. This form of braking should only be used as an emergency stop.



Batteries should be charged in a well-ventilated area.



If the batteries are damaged and leak, contact your dealer, as it may be hazardous to come into contact with the contents of the batteries. The wheelchair should then be stored in a dry, well-ventilated room. Spent batteries should be taken to the local authority's waste disposal site for recycling. This also applies to other parts of the wheelchair, e.g. used tyres and tubes. The whole wheelchair may also be returned to the dealer to be disposed of.



If there is a strong smell during charging (there may be a fault with the batteries), contact your dealer, as it may be hazardous to breathe in the vapours from the battery. The wheelchair should then be stored in a dry, well-ventilated room.



When the wheelchair is exposed to external heat sources, such as the sun's rays, the surface temperature may increase so much on some surfaces that you could burn yourself on them. This applies to dark and black surfaces in particular.



Warning; the wheelchair's operating parameters can be adjusted, so they fall outside the limits specified in the standard (EN 12184). The user must beware of the dangers this can lead to, such as long braking distances. Always let the dealer carry out adjustments and settings



Warning; there is a danger of the wheelchair being caught up on poor terrain, e.g. loose sand or deep holes.



With regard to fire hazards, it is hereby stated that the combination of the seat's foam padding and upholstery has been tested and approved in accordance with EN 1021-1:2006 and EN 1021-2:2006



Only equipment that is assembled by personnel authorised by ROLTEC may be used.



When using the chair and its functions, there may be a danger of getting stuck in it. When the control box is swung in or out to the side, there may be a risk of getting caught on the swivel fitting.



A headrest should always be used when the electrical functions - Tilt and Back - are used.



Beware that, if the chair is left in sunlight, the upholstery can get so hot that it can cause burns.



The wheelchair's lift and tilt functions are designed in such a way that it will not fall by itself, but will only move when these functions are used.
These functions are also designed to ensure continual driving.



If the wheelchair is not secured properly in a vehicle, this may cause damage to the vehicle itself, the wheelchair or the passengers in the vehicle during the journey. If you do not use a seatbelt while sitting in a wheelchair, this may lead to serious injuries in the event of an accident.



No modifications or replacements should be made to the wheelchair's mounting points or to the construction and frame parts or components without consulting the wheelchair manufacturer.



A Dahl Docking Station may only be incorporated into a wheelchair by the qualified and authorised staff of a registered firm that carries out car adaptations. To order Dahl Docking and accessories, please contact Dahl Engineering in Denmark for further details. You can find Dahl at www.dahlengineering.dk



The wheelchair may only be transported in a vehicle that is approved or adapted for such purposes. It is safer if the wheelchair is separated from the driver's cabin. Transport in a trailer is also an optional recommendation. If the wheelchair is transported in a bus, van or other vehicle, it is essential that the chair is properly secured and that the vehicle's mounting points are firmly fixed. In all transport situations, the wheelchair must be correctly secured at the 4 tie-down points, to prevent the chair from slipping or tilting during the journey. Check that the wheelchair is properly secured and that the parking brakes are activated. The wheelchair can be locked in position by attaching the mounting straps through the fittings on the front and back, each of which has an indication label.



Follow the vehicle manufacturer's mounting instructions to secure the wheelchair. Always make sure that the mounting points on the vehicle are securely fixed. This is strongly recommended, as the heavy wheelchair may cause serious problems in the event of a road accident.



If the instructions for use are not followed carefully, this will put the user at great risk of danger and the wheelchair at risk of damage

Component list

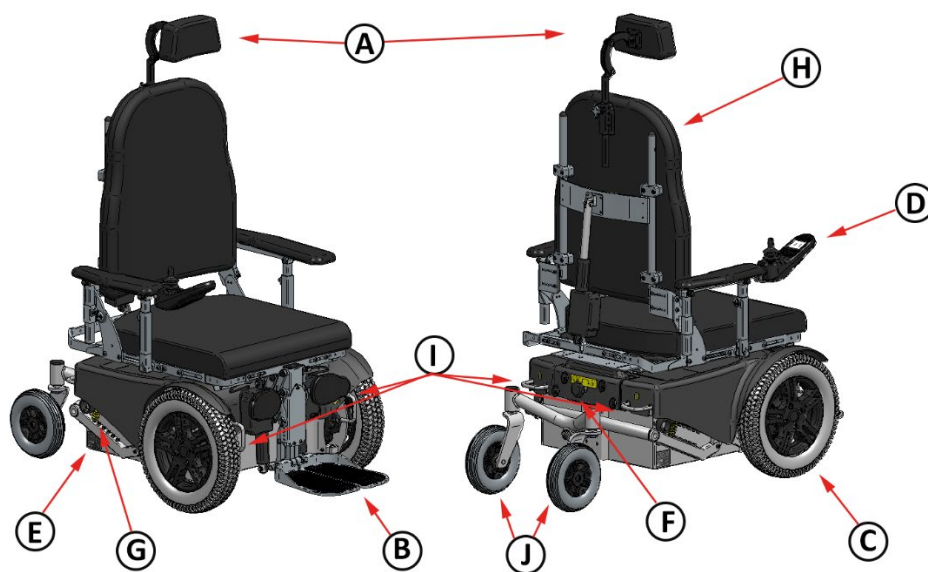

A-Headrest	B-Leg support	C-Drive wheel
D-Control box	E-Identification label	F-Push/run handle
G-Adjustable spring	H-Chair back	I-Clamping eyes
J-Flywheel	K-Armrest	L-Seat cushion

All of ROLTEC's chairs have one unique identification number (label), which is located on the right side of the wheelchair, see diagrams.

It also has information, including the max. user weight and the time of production.

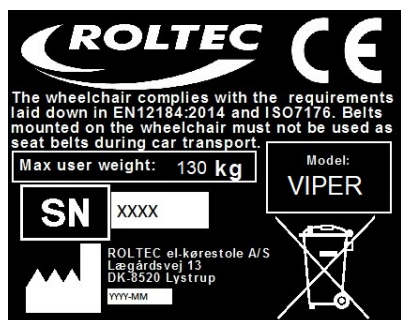

The chair must be disposed of as electrical waste, i.e. the product must not be thrown out with household waste, but should be collected separately for environmentally-friendly disposal.

Using the PG R network.

General advice on wheelchair control:

The wheelchair is switched off when there is no light on the display, and on when the display lights up.

The wheelchair's control system can be in two or more statuses: either ready to drive, or in a status in which it cannot be driven but where the joystick (control stick) can be used to operate all electrically powered parts of the chair - leg supports, seat lift, etc. - and make various adjustments to the chair.

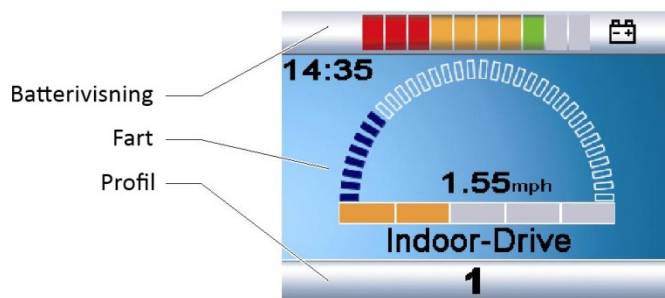

Mode:

If you want to use the control stick for any other functions other than running, you can switch from drive status to mode status (there may well be several mode statuses) by activating the mode button, and hence gain access to the wheelchair's other functions.

Use the mode button to switch from one mode to another.

Apart from the display diagrams that refer to the electrically-powered parts of your wheelchair, other mode diagrams are available if additional control equipment is fitted



The wheelchair's electrical functions are activated by moving the control stick either forwards or backwards.

If the display does not show the part of the wheelchair you want to activate, you can scroll forward to the required part by moving the control stick to the right or left.

Speed:

The maximum speed can be controlled by using the speed button on the control unit.

The speed bar in the display will show the maximum speed in the profile selected.



The speed can be controlled by using the joystick during driving. If the joystick is moved a little, the wheelchair will move more slowly.



The wheelchair's top speed is reduced when the seat is raised or tipped beyond a certain point. When this happens, it will be shown by an orange tortoise appearing in the display.

Drive profile:

The control unit can be set to make the wheelchair suitable for different environments. For example, if you select the "Soft" profile, the wheelchair will react more gently. When you are outdoors, the profile can be set to a more constant driving style.

The name of the current profile is shown at the bottom of the display.

The Profiles button allows the user to navigate through the available Profiles of the control system. The number of profiles available depends on how the control system is programmed.

Settings menu:

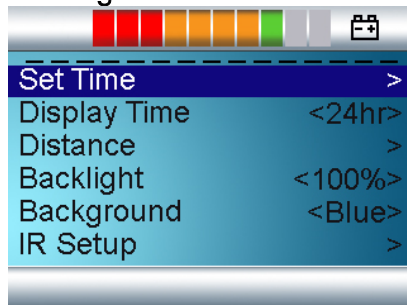

The settings menu enables you to change the clock, the light strength, background light, colour and kilometre counter.

To access the settings menu, you will need to hold down the buttons for speed down and speed up at the same time on the CJSM. On the CJSM2 there is a hazard light which needs to be held in.

The following points are then displayed in the menu:

Set time - Adjusting the time:

Turn the control stick to the right to set the time.

Select exit at the bottom of the menu to get back.

Display time:

Selecting the time format to be shown.

Selection options:

12h, 24h, Off.

Distance:



The following sub-menu appears:

Total distance: total distance the power module has driven.

Trip distance: the trip counter can be reset.

Display distance: select whether trip or total should appear in the display.

Clear trip distance: Reset the trip counter.

Exit: exit the menu.

Backlight:

Background light.

Selection options: 0% to 100% in steps of 10%.

Background:

Background. The background colour can be selected here.

Blue = blue background in all profiles

White = White background in all profiles (the display is more visible with a white background in strong sunlight)

Auto = The wheelchair can be programmed to show a different background with different profiles.

Battery indicator:



The battery indicator shows the status of the battery.

Red, yellow and green lights: Full range!

Red and yellow lights: Reduced range!

Red diodes flash slowly: Very short range! The wheelchair must be re-charged immediately to prevent damage to the batteries or stalling.

The battery indicator "increases": The wheelchair is on charge. You will not be able to use the wheelchair while the charger is connected. It must be switched off and on again to be able to run.

Locking the joystick:



The system can be locked by using the joystick, so the wheelchair is unable to run, and the system cannot be activated.

Locking the system:

1. With the wheelchair switched on, press and hold the "on/off" button.
2. After 1 second, the wheelchair beeps, release the "on/off" button
3. Move the joystick forwards until you hear a beep
4. Move the joystick backwards until you hear a beep

5. Release the joystick, you will now hear a long beep
6. The wheelchair is now locked - a symbol appears in the display



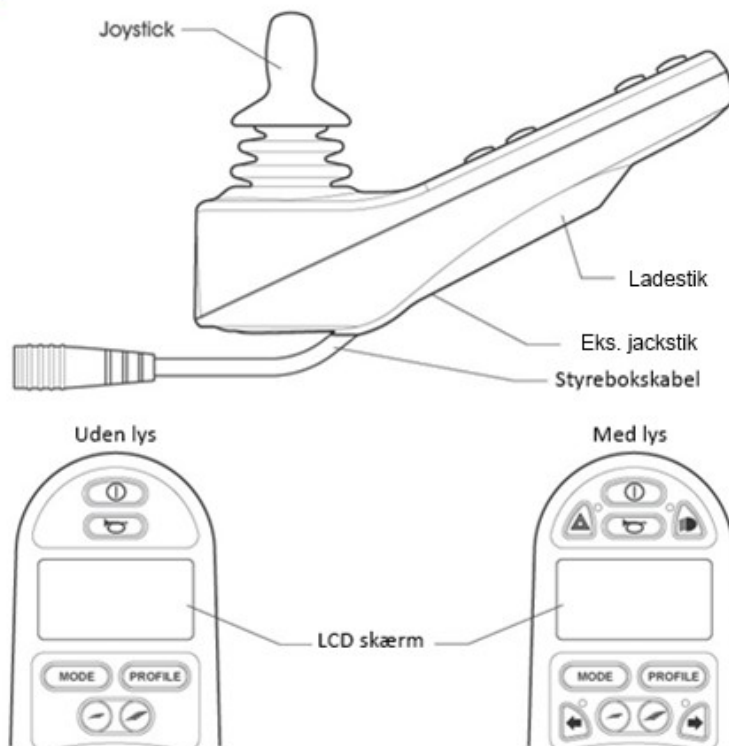

Unlocking the system

1. If the wheelchair is switched off, switch it on
2. Move the joystick forwards until you hear a beep
3. Move the joystick backwards until you hear a beep
4. Release the joystick, you will now hear a long beep
5. The wheelchair is now unlocked - the symbol disappears from the display.

CJSM:





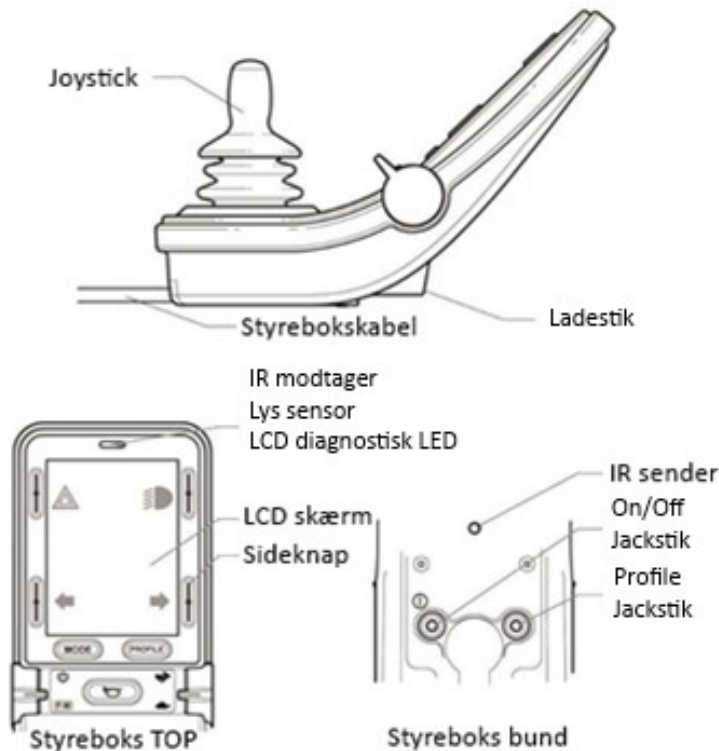

	<p>Use the on/off button to turn the chair on/off. Do not use the on/off button to stop the wheelchair, except in an emergency.</p>
	<p>The profile button allows the user to navigate between the drive profiles. The number of profiles available depends on how the control system is programmed.</p>
	<p>These buttons reduce/increase the driving speed</p>
	<p>The mode button allows the user to navigate through the different electrically-powered functions. The</p>

	<p>functions available depend on programming and the additional equipment for control.</p>
	<p>This button activates and deactivates the wheelchair's lighting. Press the button to turn the lights on and press the button again to turn them off. When the light is activated, the LED light at the side of the button indicates that it is activated. *There may be additional equipment on some models.</p>
	<p>Warning signal with sound.</p>
	<p>These buttons activate and deactivate the wheelchair's left/right flashing indicator lights. Press the button to activate the flashing and press the button again to turn it off. When the flashing light is activated, the LED light at the side of the button indicates that it is activated. *There may be additional equipment on some models.</p>
	<p>This button activates and deactivates the wheelchair's hazard light. Press the button again to turn on the hazard light. When it is activated, the wheelchair's light flashes. At the same time, the LED light at the side of the button indicates that it is activated. *There may be additional equipment on some models.</p>

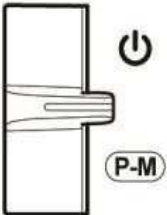
CJSM2:









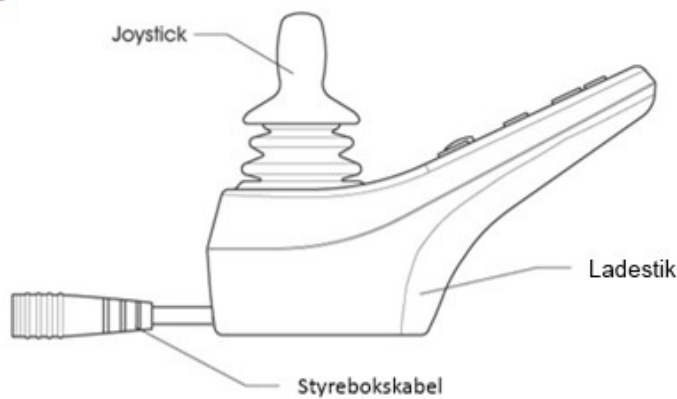

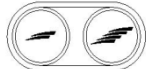
	<p>Use the on/off button to turn the chair on/off. Do not use the on/off button to stop the wheelchair, except in an emergency.</p>
	<p>The profile button allows the user to navigate between the drive profiles. The number of profiles available depends on how the control system is programmed.</p>
	<p>These buttons reduce/increase the driving speed</p>
	<p>Battery indicator</p> <p>All 10 bars light up (red, yellow and green): The wheelchair is fully charged</p> <p>7 bars light up (red and yellow): The</p>

	<p>wheelchair must be re-charged as soon as possible</p> <p>3 bars light up or flash slowly (red): The wheelchair must be re-charged immediately to prevent damage to the batteries.</p>
	<p>The mode button allows the user to navigate through the different electrically-powered functions. The functions available depend on programming and the additional equipment for control.</p>
	<p>These buttons control the wheelchair's lighting functions. The function for each button is illustrated with an icon, which appears on the LCD screen at the side of the button. When the function is activated, the icon will light up or flash.</p>
	<p>Warning signal with sound.</p>

JSM:

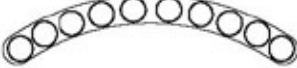

	<p>Use the on/off button to turn the chair on/off. Do not use the on/off button to stop the wheelchair, except in an emergency.</p>
	<p>These buttons reduce/increase the driving speed</p>
	<p>The mode button allows the user to navigate through the different electrically-powered functions. The functions available depend on programming and the additional equipment for control.</p>
	<p>This button activates and deactivates the wheelchair's lighting. Press the button to turn the lights on and press the button again to turn them off. When the light is activated, the LED light at the side of the button indicates that it is activated. *There may be additional equipment on some models.</p>
	<p>Warning signal with sound.</p>
	<p>These buttons activate and deactivate the wheelchair's left/right flashing indicator lights. Press the button to activate the flashing and press the button again to turn it off. When the flashing light is activated, the LED light at the side of the button indicates that it is activated. *There may be additional equipment on some models.</p>
	<p>This button activates and deactivates the wheelchair's hazard light. Press the button again to turn on the hazard light. When it is activated, the wheelchair's light flashes. At the same time, the LED light at the side of the button indicates that it is activated. *There may be additional equipment on some models.</p>
	<p><u>Setting the electrically-powered functions</u></p> <p>Press on the "Mode" button to select drive or set electrically-powered functions.</p> <ul style="list-style-type: none"> - When no symbols (back, seat, leg supports) light up, the wheelchair is in drive mode. - When one of the symbols lights up, the electrically-powered functions can be set. <p>Move the control stick to either side to select the function to be set. Move the control stick forwards or backwards to activate, depending on the function's direction of travel.</p> <p>The following symbols light up when the function is selected: (depending on which functions are available on the wheelchair)</p> <p>L. leg support: the symbol for the left leg support lights up R. leg support: the symbol for the right leg support lights up Both leg supports: both symbols (R. and L.) light up at the same time. Back: the symbol for back lights up</p>

	<p>Tilt/tip: the symbol for back and seat flashes and for both leg supports lights up Lift: the symbol for seat flashes and for back and both leg supports lights up</p>
	<p>Speed indicator.</p> <p>Lit constantly: Shows max. speed: 1 lit light diode is the lowest speed, and 5 lit light diodes is the max. speed.</p> <p>Light diodes flash: the speed is limited for safety reasons</p> <p>Light diodes move up and down: The joystick has been locked.</p> <p>Profile indicator: If profiles have been selected instead of max. speed, the light diodes indicate the profile selected.</p>
	<p>Battery indicator Shows that the wheelchair is on, plus the status of the batteries.</p> <p>Red, yellow and green lights (1-10 lights): The wheelchair is re-charged.</p> <p>Red and yellow lights (1-7 lights): The wheelchair must be re-charged.</p> <p>Red lights (1-3 lights constant or flashing): The wheelchair must be re-charged immediately to prevent damage to the batteries.</p> <p>Light diodes move up: The wheelchair is on charge and is prevented from running while it is being charged. The wheelchair must be switched off and on again to be able to run.</p> <p>The light diodes move up and down: If the joystick is activated before or at the very moment the wheelchair is switched on, the light diodes move up and down to indicate that the joystick is not in the centre position when the wheelchair is switched on. Return the joystick to the centre position to enable driving.</p> <p>If the joystick is not centred within 5 seconds, it will not be possible to drive the wheelchair, even if the joystick is centred. 7 light diodes will flash (counting from the left). Switch the wheelchair off and on again to drive when the joystick is centred.</p> <p>If a different number of light diodes start to flash, this could indicate that there is a fault in the system.</p>

Swivel bracket

When getting in or out of the wheelchair, or when positioning the chair at a table, the user can swing the control box out to the side, parallel to the arm rest.

The control box is locked when it is turned inwards to the drive position. Release the lock that is located on the inner side of the control box and push on the inside of the box to move it out to the side.

Charging:

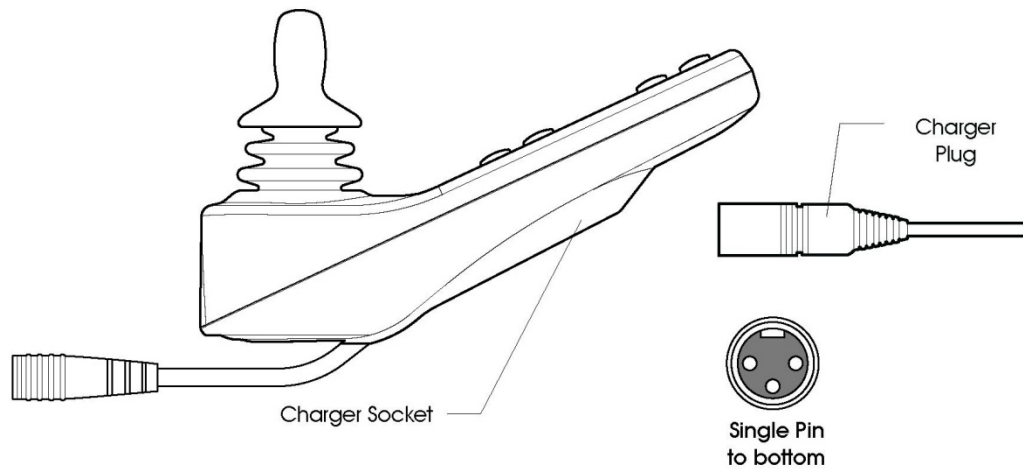

! Batteries should be charged in a well-ventilated area.

The wheelchair uses “dry” gel batteries. These batteries are completely sealed and are maintenance-free.

Note that the chair cannot be driven as long as the charger is connected. When charging is complete, the charging connector should be removed, and the wheelchair can then be switched on in the normal way.

You can expect to drive a distance of 28, 40 or 50 km per charge, depending on the type of batteries that are installed. The driving distance will be reduced if the chair is equipped with additional electrical equipment.

The battery charger must first be connected to a 220 V socket. Then plug the battery charger connector into the wheelchair’s charging connector, which is in the control unit. Always ensure the chair is fully charged.

If the wheelchair is not used for extended periods, ensure the batteries are re-charged regularly, otherwise they will become damaged. This can be done by keeping the charger switched on and connected to the chair. It will then re-charge the batteries itself when it is required. The wheelchair should be stored in a dry, well-ventilated room.

! Avoid touching leaking batteries, as the contents can be harmful to your health. If the batteries are leaky, it is extremely important to place the chair outside or in a very well-ventilated room.

! Only plug the charging connector into the battery re-charging connector, nothing else.
Danger of short circuiting!

! Only use the charger supplied.



See accompanying instructions for using the charger.

The chair's mechanical settings

! Any mechanical settings of the wheelchair must not be carried out with the user in the chair, and should only be carried out by personnel who are familiar with the chair's design and functionality.

Seat depth

Adjusting the seat depth is done in two stages:

1. Positioning the height-adjustable seat
2. Adjusting the back

Height-adjustable seat:

The height-adjustable seat can be positioned at 3 different levels A, B and C. This allows for the following seat depths: **1**: 37-47 cm, **2**: 40-50 cm and **3**: 43-53 cm.

1. Remove the 4 bolts holding the adjustable seat (Fig. 1 - Pos. A).
2. Position the seat at the desired level - 1, 2 or 3.
3. Replace the 4 bolts (Fig. 1 - Pos. A).

Back:

1. Loosen the 2 bolts on either side of the seat (Fig. 1 - Pos. B).

! The bolts must not be removed, just loosened.

2. Move the back forwards or backwards to the desired position.
3. Tighten the 2 bolts (Fig. 1 - Pos. B).

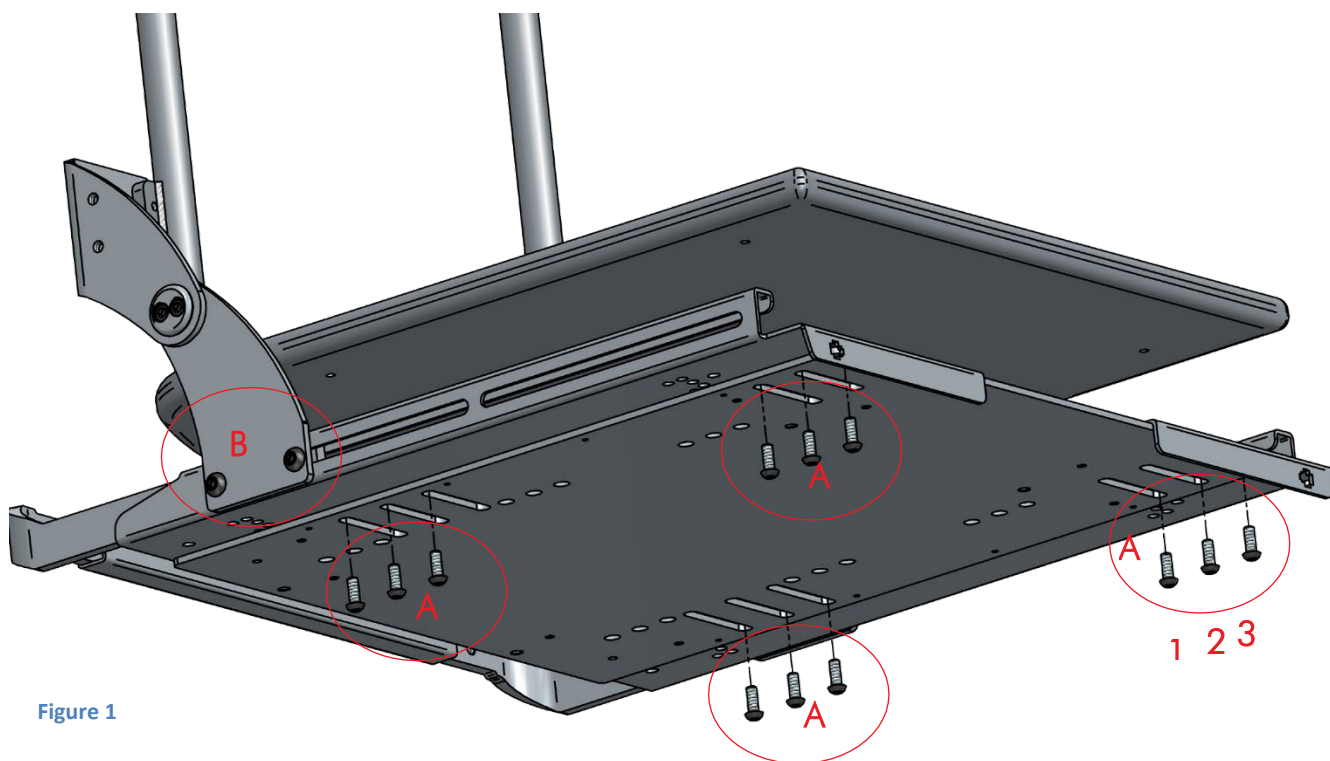

Figure 1

Back height

1. Loosen the 4x2 bolts (Fig. 2 - Pos. A) on the back cushion.
2. Move the back cushion up or down to the desired position.
3. Tighten the 4x2 bolts (Fig. 2 - Pos. A) on the back.

Chair back height

The back is available in 2 heights: 500/570 mm

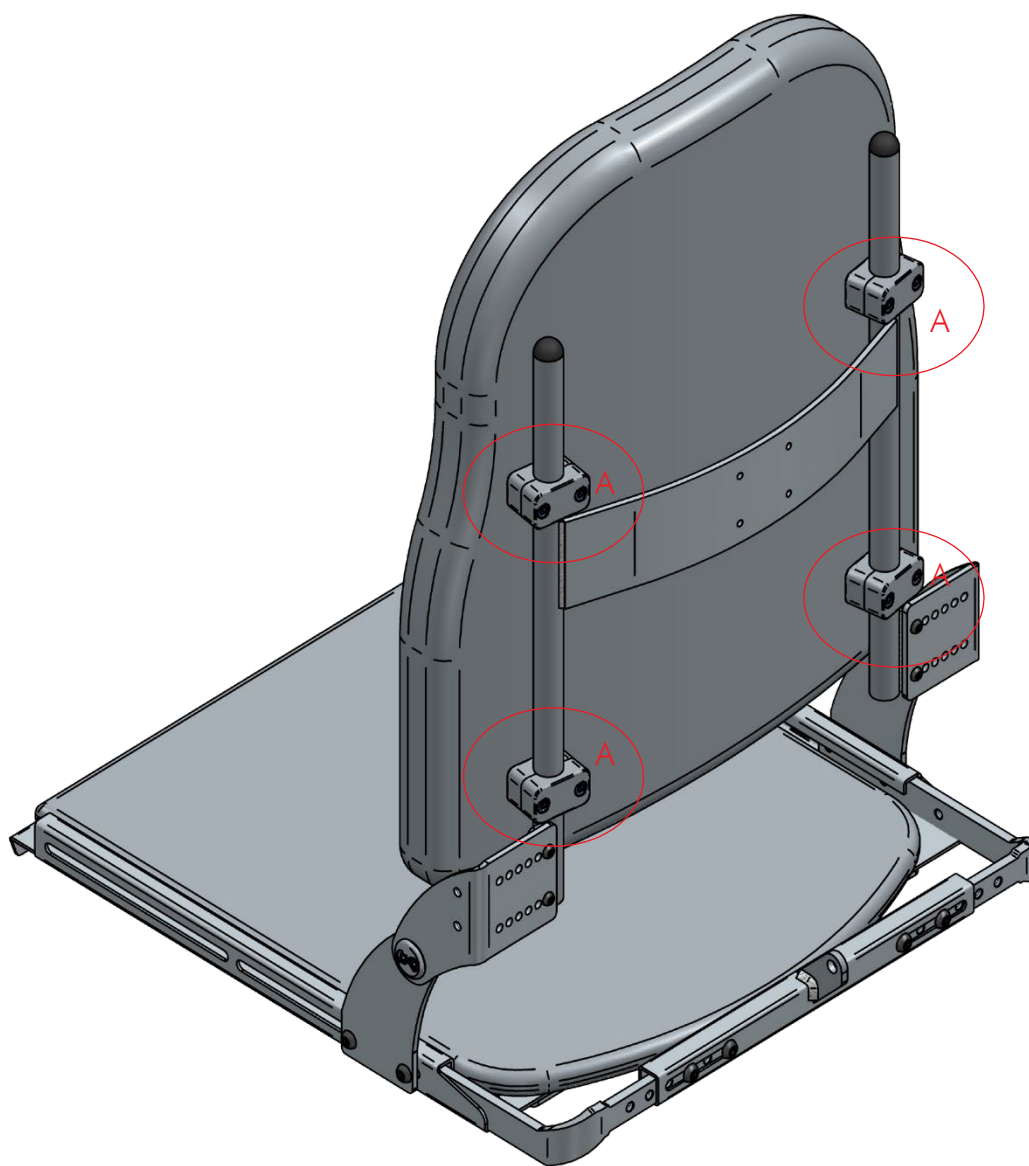

Figure 2

Adjusting the foot support

Adjusting the calf support

1. Loosen the two hex bolts. (Fig. 3 - Pos. A)
2. Turn the calf support to the desired position and tighten the two bolts.
3. If the desired position is not achieved, the calf support can be moved up and down the row of threaded holes.
4. Repeat the procedure for the other calf support.

Adjusting the position of the leg support

1. Loosen the four hex bolts. (Fig. 3 - Pos. B).
2. Move the leg support to the desired position.
3. Tighten the bolts.

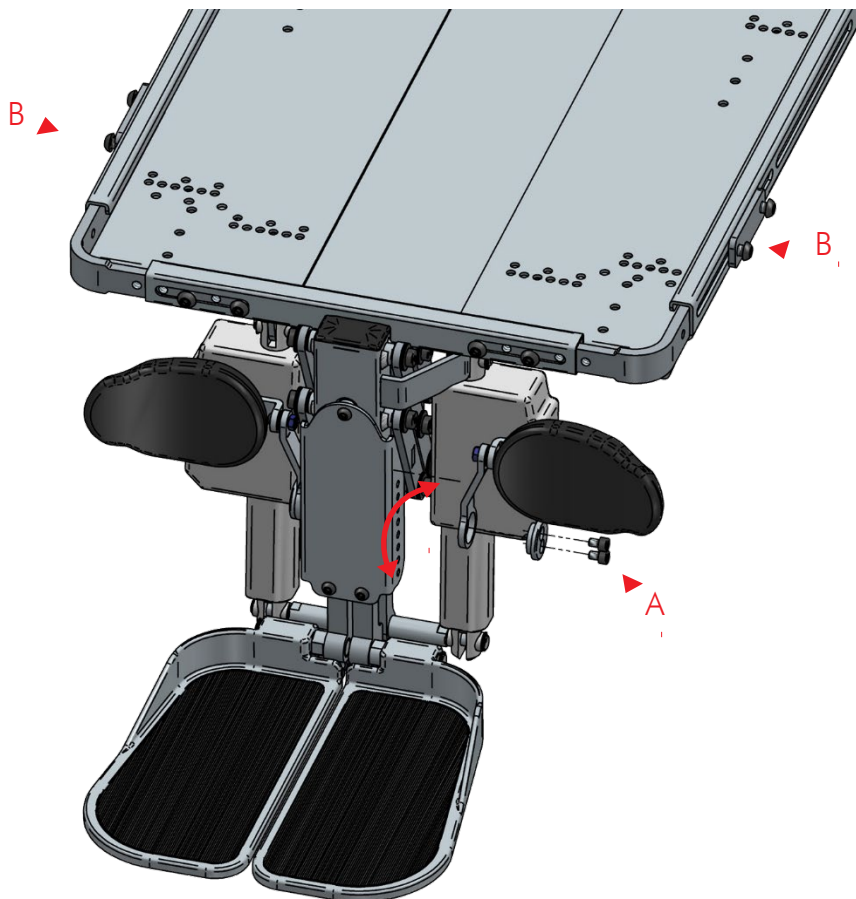

Figure 3

Angle of the foot plate

1. Loosen the nut as shown on the drawing. (Fig. 4 - Pos. A)
2. Turn the hex bolt to the desired position. Turn clockwise to reduce the angle of the foot plate. Turn anti-clockwise to increase the angle of the foot plate.
3. Tighten the nut while holding the hex bolt back.
4. Repeat the procedure for the other foot plate.

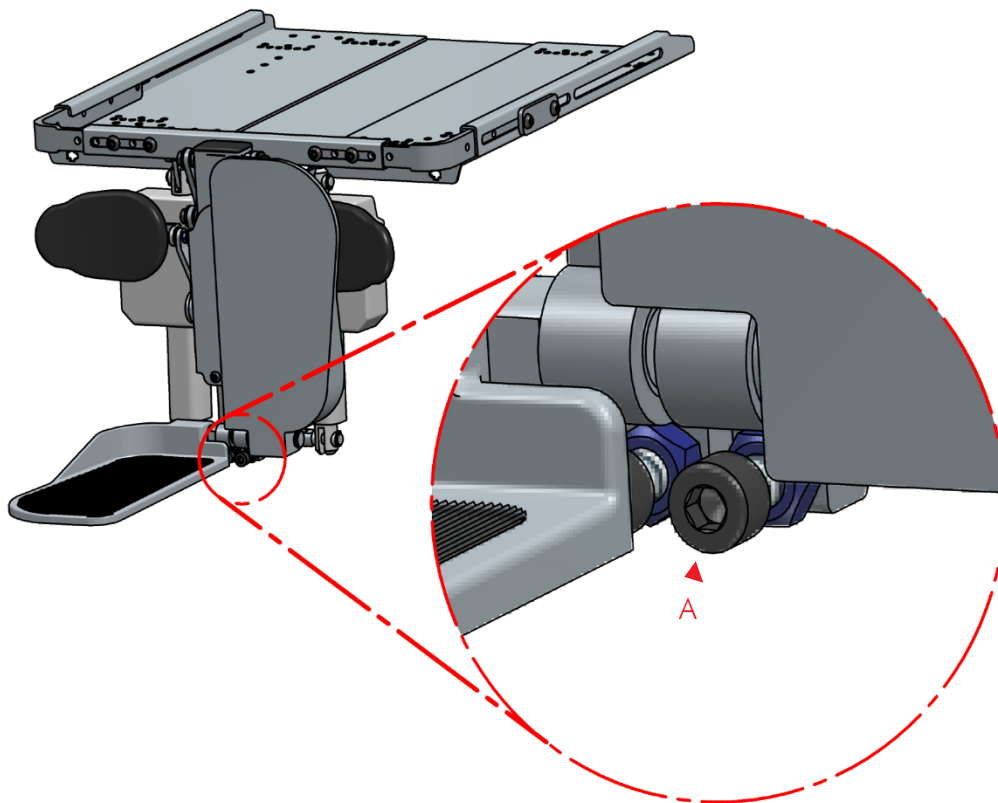
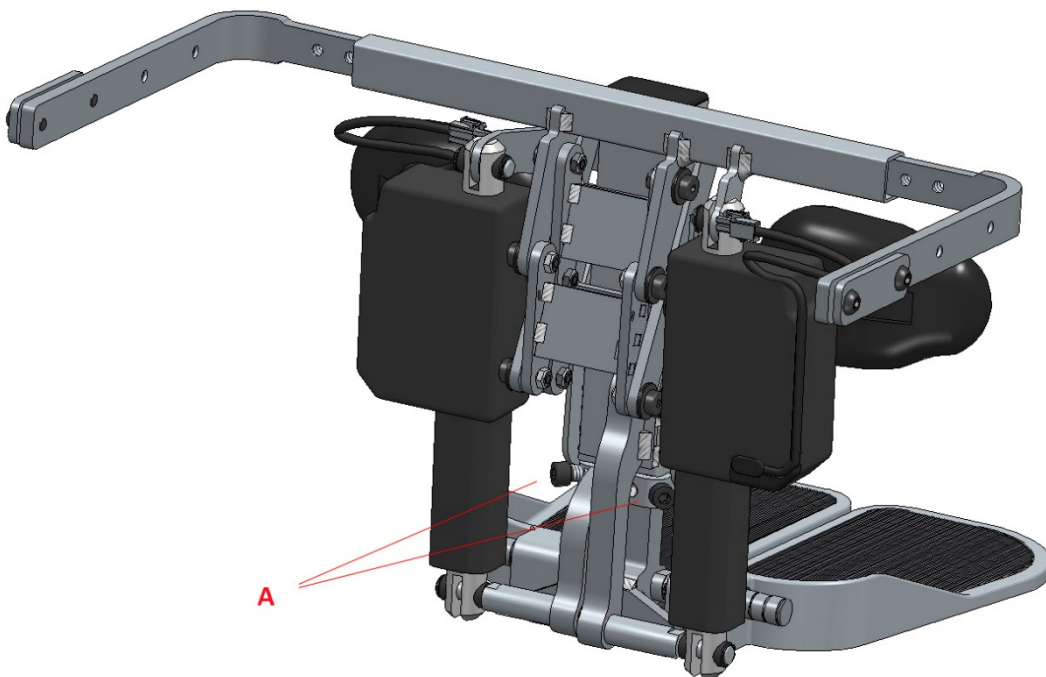

Figure 4

Adjusting the length of the leg support

The length of the leg support can be adjusted from 340 mm to 530 mm, and the length from cushion to foot plates can be set independently of each other.

1. Loosen the screws (A) on the rear of the leg support with the hex key (size 6mm).
2. To the desired length.
3. Re-tighten the screws (A).



Armrest

Armrest height

1. Loosen the four bolts (Fig. 5 - Pos. A).
2. Move the armrest to the desired height.

Note: The angle of the armrest can be adjusted by positioning the front and rear supporting legs at different heights.

3. Tighten the four bolts (Fig. 5 - Pos. A).

Note: To raise the armrest higher than the “standard” height, you will need to change the side brackets from right to left and turn them upside down.

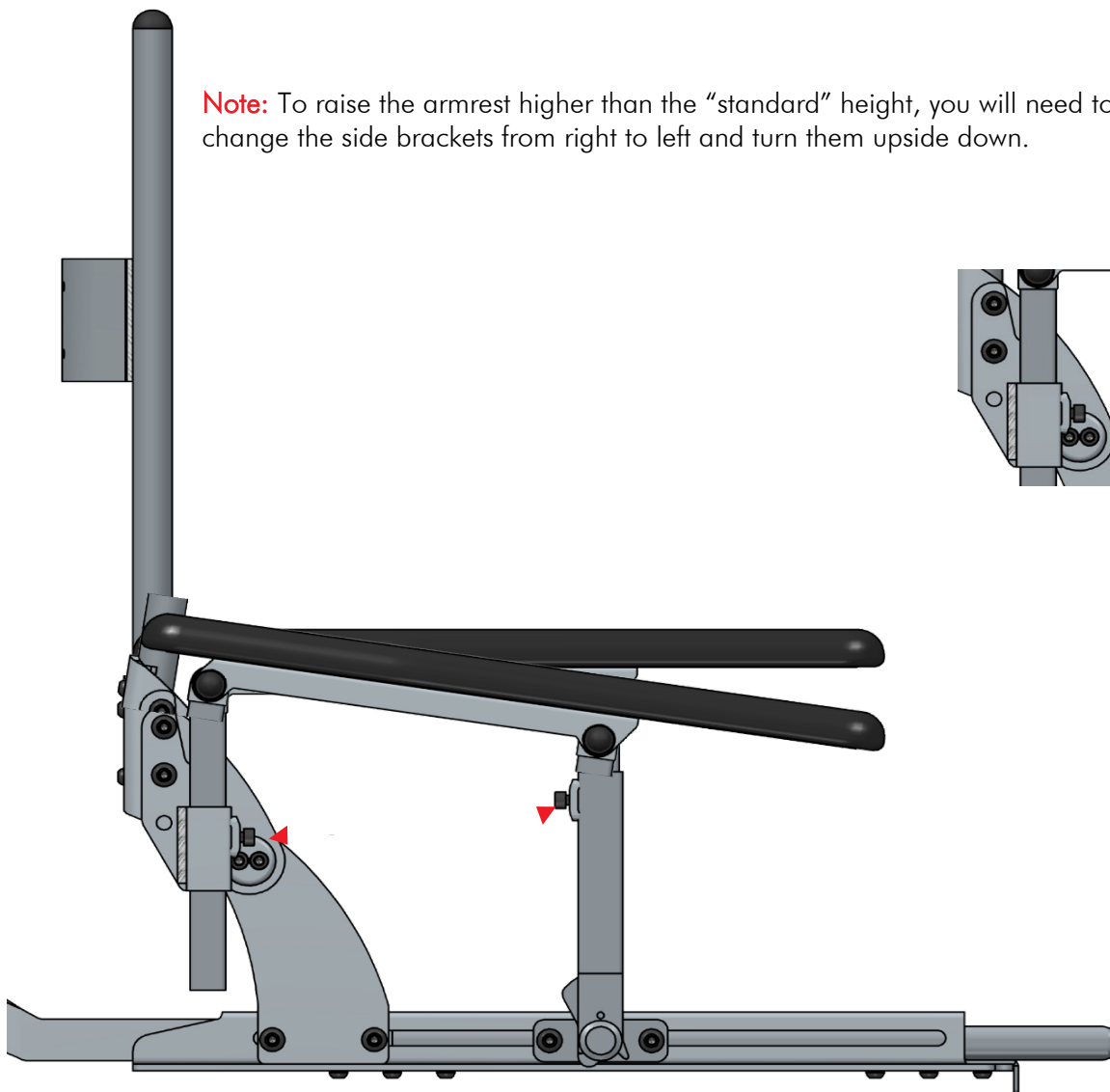

Figure 5

Armrest cushions

1. Loosen the two bolts (Fig. 6 - Pos. A) holding the armrest cushion.
 2. Move the armrest cushion forwards or backwards to the desired position.
 3. Tighten the two bolts (Fig. 6 - Pos. A) holding the armrest cushion.
- Note: If this is not enough, choose another set of holes in the cushion.

! If all of the holes in either row in the armrest cushion are not completely supported by the armrest rail, a reinforcing plate must be placed underneath the armrest cushion, or the armrest rail should be replaced by a longer model. Contact your dealer or ROLTEC for further information.

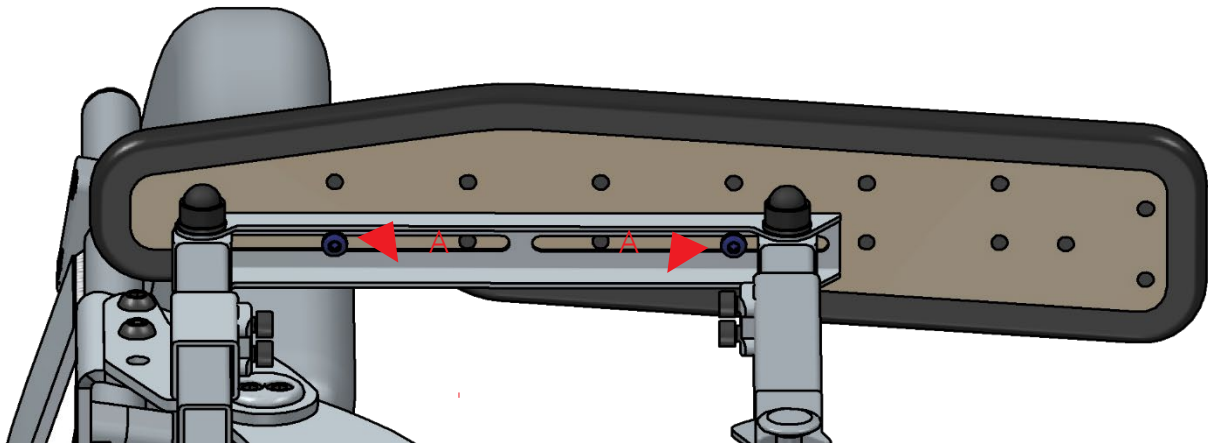



Figure 6

Transferring to and from the wheelchair.

 When transferring to and from the wheelchair, switch the chair off and ensure the brakes are on, before getting in or out.

For sideways transfer, or if a canvas aid needs to be used for the transfer, the armrests can be raised.

Press on the release button (A) and lift the armrest up

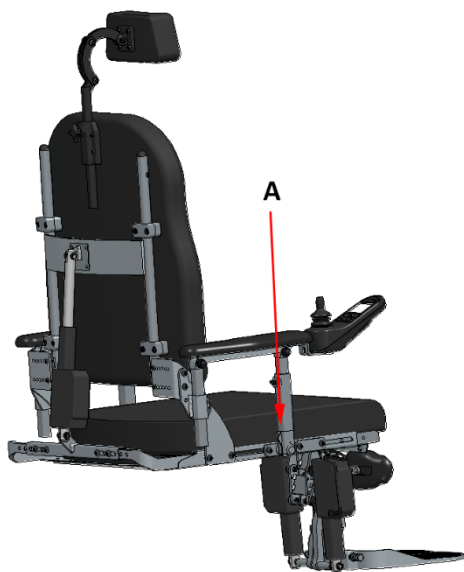

The armrests can be lifted up along the backrest to the left and right.



Headrest.

The height of the headrest can be adjusted and removed when the clamping arm (A) is loosened.

Adjustment of the headrest.

The height of the headrest can be adjusted and removed when the clamping arm (A) is loosened.

The height, angle and forward/backwards positioning of the headrest can also be adjusted in one step, when the clamping arm (B) is loosened.

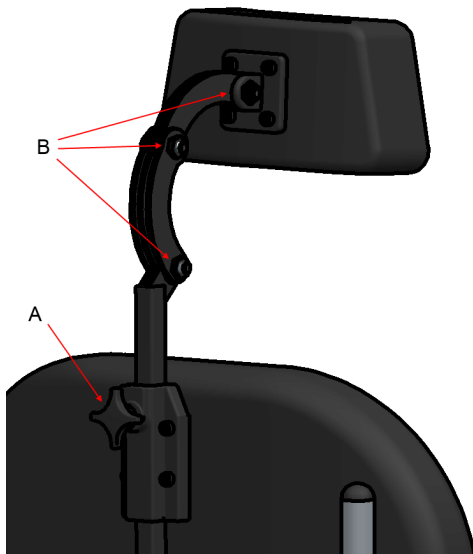

Figure 7

Suspension/Shock-absorber.

The wheelchair is equipped with suspension/ shock-absorbers. They are adjusted when supplied.

Adjusting the suspension.

! Adjustments should only be carried out by personnel who are familiar with the wheelchair's design and functionality. Do not adjust the suspension yourself.

External control box:

The wheelchair may be supplied with an external control box, which can be used instead of, or together with, the control stick and display diagrams for activating the wheelchair's electrically-powered functions.

Transport of the chair

 The electric wheelchair must not be lifted by the chair back, leg supports or armrests.

Loading/unloading

 The electric wheelchair can be loaded/unloaded using a ramp.

Securing during transportation

The electric wheelchair must be secured by means of tie-down hooks.

 The 4 approved tie-down hooks on the wheelchair (marked with hook symbols at the side of the hooks)

Transportation as freight:

The wheelchair must stand on its wheels at all times

Transportation by car:

Transporting the wheelchair and user in motorised vehicles

 You must ensure that the vehicle is suitable for the road transportation of passengers seated in wheelchairs, and that the vehicle is suitably equipped to transport a passenger in a wheelchair. Make sure that the method of unloading is suitable for your vehicle type.

 The vehicle's undercarriage and anchorage points must be able to withstand the total weight of the wheelchair, with all accessories, and the user.

 The wheelchair must be secured in a forward-looking direction. The wheelchair is crash-tested in accordance with ISO 7176-19: Mobile equipment on wheels used as seats in motorised vehicles, and meets the requirements for head-on collisions for forward-facing seating. The wheelchair has not been tested for other collision directions in a motorised vehicle.

Note: WTORS must be used in accordance with the manufacturer's instructions.

WTORS: Is an abbreviation of Wheelchair Tie-down and Occupant Restraint System, which is used in ISO standards 7176-19 and 10542. It is a complete system consisting of equipment for securing the wheelchair and a seat belt for the user. The abbreviation WTORS will be used in this user manual.

⚠ The wheelchair may only be secured at the anchorage points marked on the chair's frame.

⚠ The anchorage points (2 in front, 2 at the rear), are marked with a hook symbol.

⚠ Tie-down equipment must not be fastened to the wheelchair's accessories, such as armrests, support arms, anti-tip protection or other fittings.

⚠ Modifications or replacements must not be carried out on the wheelchair's anchorage points for a docking system, 4-point tie-down restraint system or the wheelchair's other construction, without the prior consent of the wheelchair manufacturer.

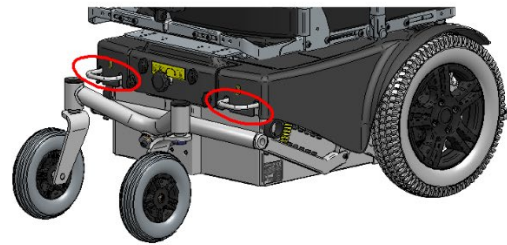
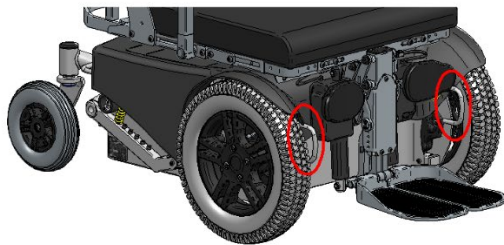

Symbol for tested anchorage point for tie-down straps.

Securing the wheelchair with a strap system

⚠ The standard 4-point WTORS is only tested for a wheelchair weighing 85 kg + user in accordance with ISO 10542-1.

⚠ For securing wheelchairs weighing over 85 kg, it is recommended that you use a heavy duty system, which conforms to ISO 10542, and which is tested for its ability to withstand the total weight of the wheelchair, including all options. For a heavy duty system, 4 straps are used to secure the wheelchair, 2 straps in front and 2 straps behind.

⚠ If a standard 4-point WTORS is used to secure a wheelchair weighing more than 85 kg, 6 straps must be used to secure the wheelchair. 2 straps in front and 4 straps behind.

⚠ Never use tie-down equipment that does not carry the ISO 10542 approval marking.

Angles for tie-down straps

When tie-down straps are installed, their angles must fall within the preferred angles shown below.

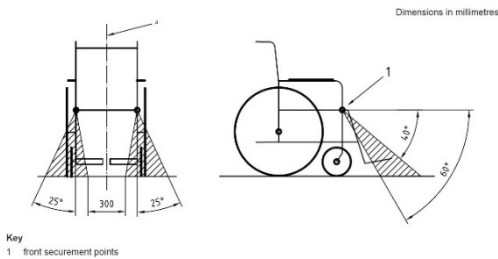



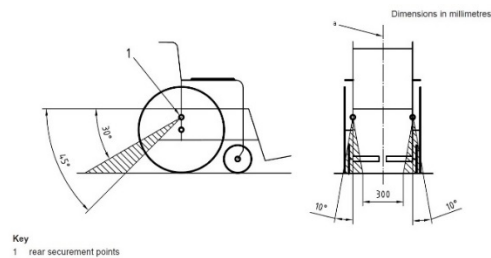

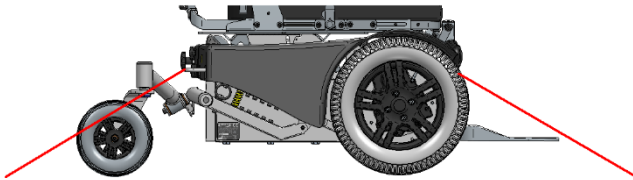

Preferred angles for the front tie-down straps



Preferred angles for the rear tie-down straps



General instructions for seat belts for restraining wheelchair users

-  Use a 3-point seat belt system to secure the wheelchair user. The belt must have the approval mark ISO 10542, e (EU European certification) or (E) (UNECE certification).
-  If the lap belt and shoulder belt can be separated, both should be used to restrain the user and reduce the risk of injury to the head and chest in the event of a vehicle collision.
-  The user's seat belt must securely attached to suitable points in the vehicle.
-  Use an appropriate head restraint during transport.
-  A postural belt (e.g. a lap belt or other supporting belt), which is secured to the vehicle's seat or frame, must not be used as a seat belt or be relied on to restrain a wheelchair user in a vehicle in motion.
-  The seat belt should be in full contact with the shoulder, chest and pelvis, and the lap belt should be positioned low across the front of the pelvis, where the pelvis and thigh meet (see ISO standard 7176-19) (Fig. 7).
-  The transverse belt to the torso should run, as illustrated, obliquely across the chest and close to the mid-point of the shoulder.

⚠️ The seat belt should be worn as tightly as possible without impairing the user's comfort.

⚠️ Seat belts must not be twisted during use.

⚠️ Care must be taken with the positioning of the seat belt lock, so that the release catch does not come into contact with vehicle components during driving or a collision.

⚠️ The seat belt must not be held away from the body by vehicle components or parts, such as the arm rest or wheel.



Figure 6 — Illustration of improper belt-restraint fit

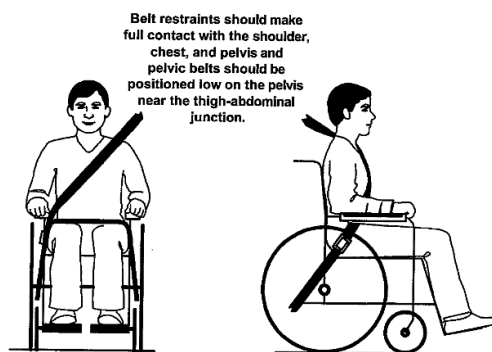

Figure 7 — Illustration of proper belt-restraint fit

Text for Figure 6

Illustration of an incorrect seat belt installation

Text for Figure 7

Illustration of a correct seat belt installation

Positioning the seat belt when using a 4-point strap tie-down system

⚠️ The lap belt should be positioned low across the front of the pelvis, thus forming an angle that falls within the preferred or optional zone of 30° to 75°, as shown in the illustration. A more abrupt (larger) angle within the preferred zone of 45° to 75° is desirable, but never more than 75°

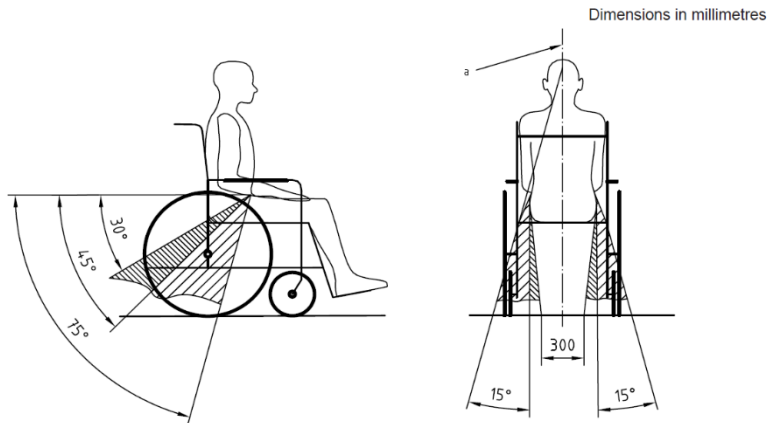

Key
 preferred zone
 optional zone

Preferred and optional angles for the lap belt when a 4-point WTORS is used

Positioning the seat belt when securing a wheelchair with a Dahl docking system

! When a wheelchair with a Dahl docking system is secured, the floor anchoring points for the seat belt should be placed 10 to 60 mm on the outer side of the wheelchair’s wheels. The lap belt should be positioned low across the front of the pelvis, thus forming an angle that falls within the preferred or optional zone of 30° to 75°, as shown in the illustration. A more abrupt (larger) angle within the preferred zone of 45° to 75° is desirable, but never more than 75°.

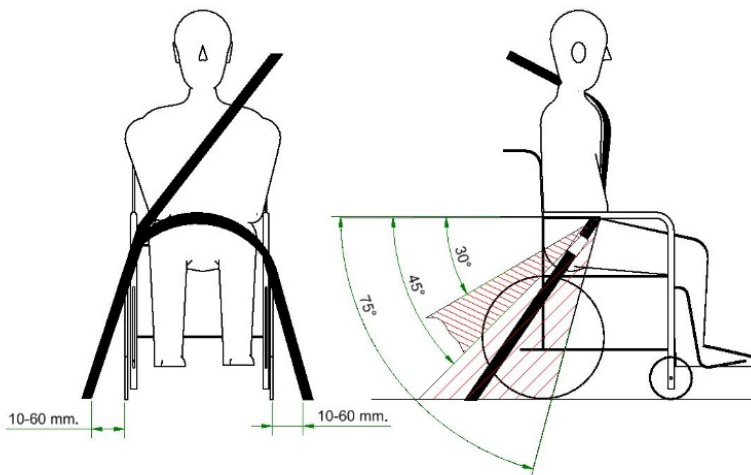

Preferred and optional angles for the lap belt when a Dahl Docking System is used

Contents of Dahl Docking Station #501750



(Photo #501750)

Mounting of Dahl docking locking plate underneath the wheelchair

To be able to mount the locking plate for the docking system underneath the wheelchair, you must order a wheelchair-specific adaptation set from ROLTEC. The set contains special bolts and spacers, which should be mounted underneath the chair.

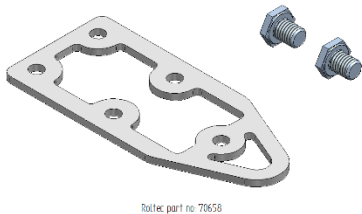

Use the ROLTEC adaptation set Art. # 70658, to mount the locking plate

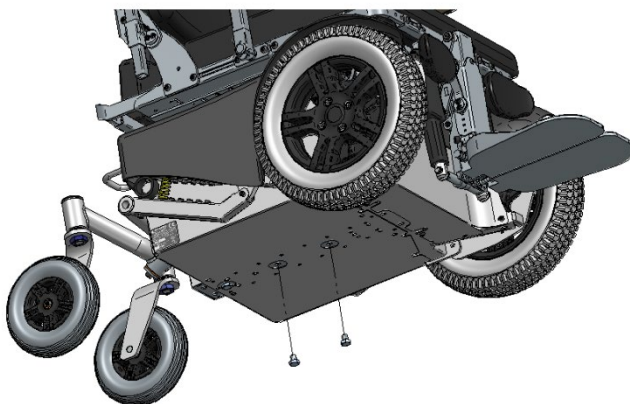

1. Remove the 2 bolts under the lift, see figure.

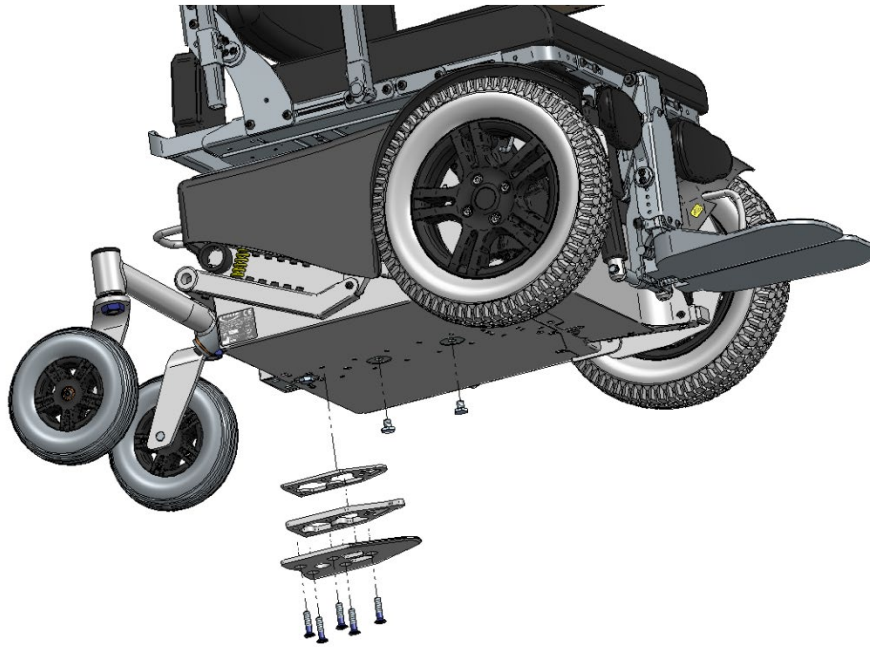

2. Mount the adaptation set from ROLTEC, where the 2 bolts are removed.
3. Mount the supplied 8 mm spacer + adaptation set on the locking plate and mount the 5 bolts (Dahl #502800) through the spacer, adaptation set and locking plate. Insert the 5 bolts into the nuts and tighten them to a torque of 16-18 Nm.

 Do not use any bolts other than the original bolts, which are supplied by Dahl Engineering (Art # 502800, which are of quality 14.9, torx key size 27). Standard M8 bolts with countersunk heads are not strong enough in the event of a collision.

Use Loctite 222 (or an equivalent from another manufacturer) to secure threads on all bolts.

Carry out a final check by locking the wheelchair firmly in position in the docking station. Check that the locking plate is correctly locked and verify that all release methods work as intended. A warning tone will sound if the locking plate has not been inserted all the way into the docking station.

Description of function for Dahl Docking System

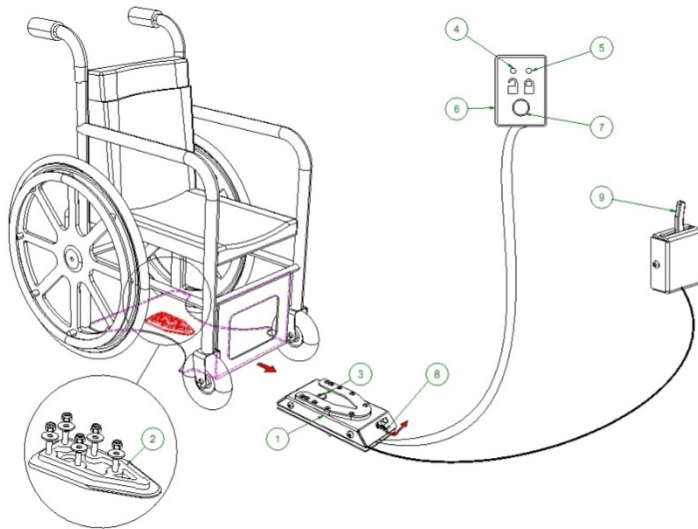

- (1) Dahl Docking Station
- (2) Locking plate and 8 mm spacer plate
- (3) Locking pin
- (4) Red LED
- (5) Green LED
- (6) Control panel
- (7) Push button/Release button
- (8) Manual emergency release
- (9) Manual release catch

Securing the wheelchair in the docking station

1. Drive slowly and evenly over the docking station. The locking plate underneath the wheelchair helps to guide the wheelchair into place in the docking station. When the locking plate is positioned far enough forward in the docking station, a spring-loaded locking pin automatically secures the locking plate.
2. The docking station is equipped with a control switch that indicates whether the locking plate is correctly secured in the docking station. The moment the locking plate touches the locking pin, a warning tone is heard, and the red diode light (LED) lights up on the control panel, until the locking plate is fully in place, or the wheelchair is driven out of the docking station.
3. As an indication that the wheelchair is correctly secured, the warning tone should cease, the red light (LED) on the control panel should go out, and the green light (LED) should light up.
4. Don't forget to tighten the safety belt before driving.

⚠ Do not set the vehicle in motion:

While the wheelchair is being driven into place in the docking station.

If the wheelchair and user are not correctly secured using seat belts

If the warning tone sounds, and/or the red warning light (LED) on the control panel flashes or

lights up!

 Always check that the locking plate is correctly secured in the docking station by trying to reverse the wheelchair out of the docking station before the vehicle is set in motion. (It should not be possible to reverse the wheelchair out of the docking station without pressing the red release button on the control panel.)

Release from the docking station

1. When the vehicle is brought to a stop, remove the seat belt.
2. Drive the wheelchair as far into the docking station as you can, in order to remove the pressure on the locking pin.
3. Press the red release button on the control panel. The locking pin releases after approx. 5 seconds. The locking pin then automatically locks again.
4. Reverse the wheelchair out of the docking station before the approx. 5 seconds have passed. Do not attempt to reverse out of the docking station **before** the red LED on the control panel, which indicates unlocked status, lights up.

 Attempting to reverse out of the docking station before the locking pin is depressed fully and the red LED on the control panel lights up will block the locking pin, making it impossible to reverse out of the docking station. Repeat the above release procedure when this happens.

Manual release in the event of an electrical fault.

In the event of an electrical fault, a manual emergency release has been placed on the docking station beforehand.

1. The red release arm is pushed to the side and secured while the wheelchair is driven away.
2. A cable-activated manual control lever can also be installed as an accessory. The red release arm is also pushed to the side and secured while the wheelchair is driven away.

If the described procedures for manual release fail, an emergency release tool is also supplied in red plastic with each docking station.





1. Drive the wheelchair as far into the docking station as possible, in order to remove the pressure on the locking pin.
2. Place the release tool in the slot between the locking plate and the docking station.
3. Push the release tool and wheelchair forward firmly until the locking pin is forced down - the wheelchair can then be reversed out of the docking station.

Please refer also to Dahl Engineering's directions for assembly, use and maintenance.

Mounting the Dahl Docking System in the vehicle

Dahl Engineering only sells the docking station to professional vehicle conversion companies for the transportation of wheelchair users. The mounting should be carried out by a qualified and experienced technician/fitter. Dahl Engineering can supply vehicle-specific mounting instruction manuals for a large number of vehicles, which the fitter can follow. Please contact Dahl Engineering for information on approved vehicles and mounting positions.

Dahl Engineering's contact details can be found at: www.dahlengineering.dk

Positioning belts:

The wheelchair can be supplied with different types of belts from our large belt selection. The belts can be fastened as required on the seat's C-profile or the seat's back.

Fittings for mounting the lap belt are installed in the C-profile on both sides of the seat, as in Fig. 8.

 Belts mounted on the wheelchair must not be used as personal seat belts during car journeys. The car's seat belts must be used by the user at all times.

This rule applies, regardless of whether belts are used in the wheelchair's tie-down hooks - Dahl's Docking System and tie-down systems.



Figure 8 installing the lap belt

Push function

The electronic brake can be disconnected if it is necessary to move/push the wheelchair manually.

The electric vehicle's motors are equipped with automatic brakes that prevent the electric vehicle from rolling. This brake can be disconnected if it is necessary to move/push the wheelchair manually.

On the Viper, the brake release lever is located behind the chair. It is marked with a sign. The brakes are released when the levers are turned to the right.

When the brakes are disconnected, the wheelchair cannot be driven with the joystick. The brakes must be engaged, and the wheelchair switched off and on, before the chair can be driven again.

! Transfer to/from the electric wheelchair is only allowed when the wheelchair is turned off and the lever for switching between the drive and push function is turned to the right.

! When the brakes are disconnected, the wheelchair will "beep" and show "PM Brake error" in the display, to warn that the brakes are disconnected as long as the chair is turned on.

! All wheelchairs can roll by themselves when the brakes are switched off manually, if they are standing on a sloping surface.

! The push function may only be disengaged by an attendant, not the user themselves. This ensures that the motors are disengaged in the presence of an attendant who is able to ensure that the electric vehicle does not move without supervision.

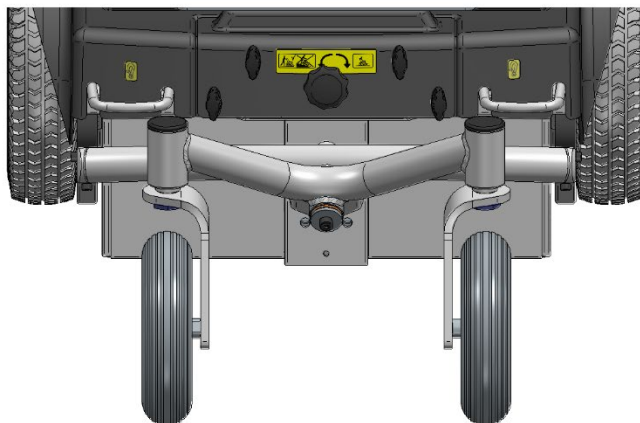

The brakes are active when the levers are turned to the right.
The brakes are released when the levers are turned to the left.

Brakes.

The wheelchair brakes when you let go of the joystick and it returns to the vertical position. It is possible to adjust the speed at which the chair brakes, so that there is less overrun. A short overrun will make the chair brake abruptly. This adjustment must be carried out by ROLTEC

 Pay particular attention to the overrun when using ramps. Let go of the control stick and brake before the edge of the ramp.

Emergency brake. The wheelchair's emergency brake is activated by pressing the ON/OFF button, which turns the wheelchair off. This method of braking results in very abrupt braking

It is possible to adjust the speed at which the chair brakes.
This adjustment must be carried out by ROLTEC.

Lights and reflectors

The wheelchair is equipped with reflectors on the front and rear.
Lights and flashing lights are optional extras.

Access to the battery room

Access to batteries and electronics is gained by removing the wheelchair's tyre shield:



1. Move the lift/tilt module all the way to the top.



If the lift/tilt module cannot be raised electrically,
first remove

2. Remove the 4 wing nuts on the collecting shield at the rear and remove the collecting shield.

3. Now unscrew the lever for disconnecting the mechanical brakes behind the chair. This is done
by screwing hard anti-clockwise.

4. One person can now lift up the seat frame while another person affixes the lift stop bolt to the lift column (or a piece of an iron bar across the holes in the lower front corner of the upper seat lift frame).

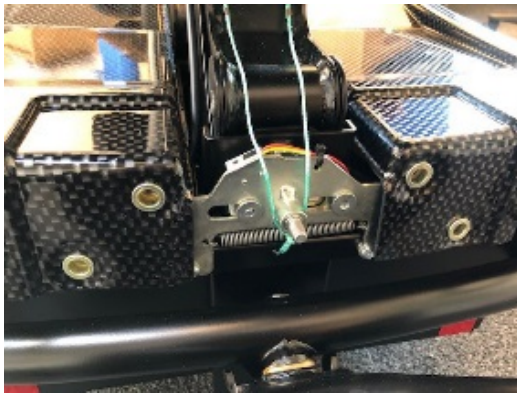

Pull the coloured cord in the lift. The lifting system is now released, and one person can now lift up the seat frame while another person affixes the lift stop bolt to the lift column.

If you could raise the lift electronically, do 2 and 3.

5. Lift the shield up slightly and push it forward so that it is free of the lift. Before you remove the shield completely, unplug the light switch (located underneath the shield).
6. To replace the shield, follow the above procedure in reverse.
7. If the lift could not be raised electrically when mounting the shield, it is important that someone holds the seat lift up when the lift stop bolt is pulled out, as otherwise the seat will drop down to the bottom position. This applies if electric lift/tilt is not installed, or if the lift was at the bottom before the lift stop bolt was affixed.

Access to the batteries

To gain access to the batteries, remove the 2*2 screws located in the battery holders.



Figure 6 Battery replacement

Batteries:

Batteries: The batteries should be replaced by the dealer. The dealer will ensure that the batteries are disposed of in the most environmentally-friendly manner. If the batteries are damaged and leak, contact your dealer, as it may be hazardous to come into contact with the contents of the batteries.

See label for wiring diagram.

⚠ Avoid touching leaking batteries, as the contents can be harmful to your health. It is important to place the chair outside or in a very well-ventilated room.

Tyres:

To ensure the wheelchair works properly, it is important that the tyres have the prescribed pressure. The maximum pressure is stated on the tyre. The inner tubes in the tyres are equipped with auto-valves. They can therefore be pumped with an automatic pump.

ROLTEC recommends air pressure in the large tyres of: 40 PSI.

! Check the air pressure at least once a month. Power consumption increases significantly if there is not enough air in the tyres. Different pressure in the tyres will result in uneven running. The wheelchair can be supplied with anti-leak tyres as an extra, or an anti-leak liner on both front and rear wheels.

Flywheel:

The wheel can be taken off the mono fork by removing the screw in the centre hole of the rim. Use a 5 mm hex head wrench (Allen key) to do this.

Then remove the outer bolts holding the rim halves together and pull the rim halves apart. Remove the tube from the tyre and apply a patch or replace it with a new one. Use a 5 mm hex head wrench (Allen key) to do this.

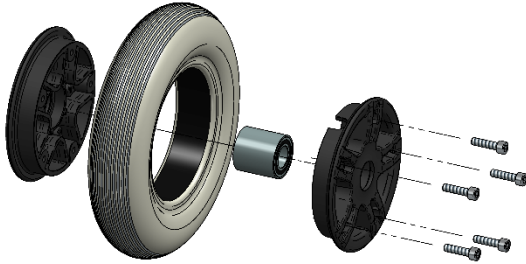

Figure 9

Drive wheel:

! Before separating the rim, force the air out of the tube by squeezing the valve.

First screw off the 4 hex bolts around the centre hole (the screws to the right) of the hub. Use a 6 mm hex head wrench (Allen key) for this.



Do not loosen the large bolt in the centre.

Remove the outer bolts on the left of the loose wheel and pull the rim halves apart. Remove the tube from the tyre and apply a patch or replace it with a new one.

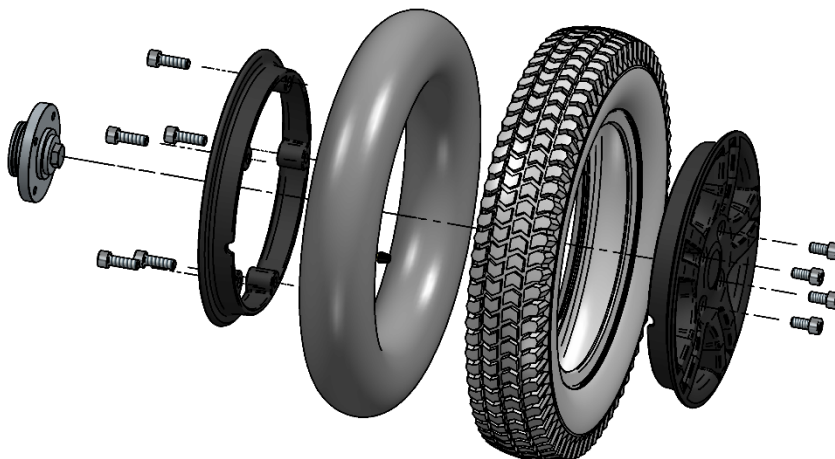

Figure 10

Disposal of the wheelchair:

The wheelchair can be disposed of by returning it to the dealer, who will then dispose of it in the most environmentally-friendly way.

This product is supplied by an environmentally-conscious manufacturer. This product may contain substances that can harm the environment if they are disposed of on sites that do not comply with current legislation.

Cleaning:

! The wheelchair must not be hosed down with water or immersed in water, but should be wiped down with a wet, wrung out cloth. Stains and scratches on the black-painted metal parts that do not penetrate the plastic covering can be removed using scouring powder on a damp cloth. Scratches that penetrate the plastic covering can be touched up by painting with spray paint.

The number of the paint used on the black metal parts of the wheelchair is RAL No.9017. The wheelchair's parts should only be wiped down with a wet, wrung cloth.

Disinfection:

The use of disinfectants for spraying or wiping is permitted if the disinfectant has been tested and approved.

A list of approved disinfectants is available at

https://www.rki.de/DE/Content/Infekt/Krankenhaushygiene/Desinfektionsmittel/Downloads/BGBI_60_2017_Desinfektionsmittelliste.pdf?__blob=publicationFile

! Do not use solvents

Recycling:

This wheelchair is designed to be reused. If the chair is to be reused, observe the regulations for cleaning and disinfection to reduce the risk of transmitting contagious diseases.

Fuse:

On the ROLTEC FWD model (centre chair), the main 100 Amp fuse is located above the 2 batteries.

Remove the wheelchair's shield to replace the fuse - see section: Access to the battery room









Storage

Put the wheelchair on charge when it is not being used to ensure that the batteries are fully charged at all times. When charging is complete, the charger switches off automatically.



Troubleshooting:







CJSM:

Fault:	Problem:	Solution:
The chair does not power up	The charging connector is inserted	Remove the charging connector
	Brake release activated	Deactivate brake release
	System error	Check cable (Contact dealer if necessary)
The chair is powered up but does not react to buttons or the joystick	System error	Turn the chair off and on again (Contact dealer if necessary)
Symbol appears in display 	The joystick is locked	Unlock the joystick: See section Locking the joystick:
Lift cannot be moved down	Something is stuck.	Check to see if something is stuck between the sub-part and the seat.
The chair can only move slowly	Decelerator lift activated	If the "tortoise" symbol appears in the display, then move the lift to the bottom.
	Decelerator tilt activated	If the "tortoise" symbol appears in the display, then move the lift to the horizontal position.
The chair pulls to one side	Wrong tyre pressure	Check tyre pressure.
Symbol appears in display 	The system has reduced effectiveness of the motors to avoid overheating.	Stop driving and let the motors cool down. They are overloaded and subject to a greater load than they are designed for.
Symbol appears in display 	The control system has become too hot and has reduced the power.	Turn the chair off and let it cool down.
	Other reasons	Contact ROLTEC.
Symbol appears in display 	If the wheelchair is being prevented from operating.	Turn the wheelchair off and on again to use the wheelchair. (Contact dealer if necessary)



Symbol appears in display 	The system has generated an error and shows a text, module and an error code	Contact ROLTEC.
Symbol appears in display 	Joystick activated	Let go of the joystick and centre it to be able to use wheelchair.
	If you activate the joystick before or at the same time as powering up, the symbol will flash.	If the joystick is activated when the chair is powered up, it cannot be driven. If it is not returned to the rest position within 5 seconds, the wheelchair should be turned off and then on again.









CJSM2:

Fault:	Problem:	Solution:
The chair does not power up	The charging connector is inserted	Remove the charging connector
	Brake release activated	Deactivate brake release
	System error	Check cable (Contact dealer if necessary)
The chair is powered up but does not react to buttons or the joystick	System error	Turn the chair off and on again (Contact dealer if necessary)
Symbol appears in display 	The joystick is locked	Unlock the joystick: See section Locking the joystick:
Lift cannot be moved down	Something is stuck.	Check to see if something is stuck between the sub-part and the seat.
The chair can only move slowly 	Decelerator lift activated	If the "tortoise" symbol appears in the display, then move the lift to the bottom.
	Decelerator tilt activated	If the "tortoise" symbol appears in the display, then move the lift to the horizontal position.

The chair pulls to one side	Wrong tyre pressure	Check tyre pressure.
Symbol appears in display 	The system has reduced effectiveness of the motors to avoiding overheating.	Stop driving and let the motors cool down. They are overloaded and subject to a greater load than they are designed for.
Symbol appears in display 	The control system has become too hot and has reduced the power.	Turn the chair off and let it cool down.
Symbol appears in display 	Other reasons	Contact ROLTEC.
Symbol appears in display 	If the wheelchair is being prevented from operating.	Turn the wheelchair off and on again to use the wheelchair. (Contact dealer if necessary)
Symbol appears in display 	The system has generated an error and shows a text, module and an error code	Contact ROLTEC.
Symbol appears in display 	Joystick activated	Let go of the joystick and centre it to be able to use wheelchair.
	If you activate the joystick before or at the same time as powering up, the symbol will flash.	If the joystick is activated when the chair is powered up, it cannot be driven. If it is not returned to the rest position within 5 seconds, the wheelchair should be turned off and then on again.

JSM:

Number of light diodes flashing:	Problem:	Solution:
1 LED 	1. The battery must be re-charged	Put the wheelchair on charge
	2. There is a poor connection to the battery.	Check the connections to the battery.
2 LED 	1. Poor connection to the left* motor	Check the connection to the motor
3 LED 	1. The left* motor has a short circuit re: a battery connection	Contact an authorised repairs service.

<p>4 LED</p> 	<p>1. Poor connection to the right* motor</p>	<p>Check the connection to the motor</p>
<p>5 LED</p> 	<p>1. The right* motor has a short circuit re: a battery connection</p>	<p>Contact an authorised repairs service.</p>
<p>6 LED</p> 	<p>1. The wheelchair has been prevented from running by an external signal, e.g. special solution with contact.</p>	<p>The reason will depend on the special solution model - Contact ROLTEC or the supplier.</p>
<p>7 LED</p> 	<p>1. Joystick not centred</p>	<p>Turn the wheelchair off, centre the joystick and turn the wheelchair on again.</p>
	<p>2. Joystick error.</p>	<p>Contact an authorised repairs service.</p>
<p>8 LED</p> 	<p>1. System error.</p>	<p>Check all connections</p>
<p>9 LED</p>  <p>+ control box beeping</p>	<p>1. Brakes are mechanically disconnected</p>	<p>Reconnect the brakes, see section Mechanical disconnection of brake</p>
	<p>2. Poor connection to brake</p>	<p>Check that the motor/brake wiring is attached firmly in the electronics box on the wheelchair.</p>
<p>10 LED</p> 	<p>1. An excess of voltage has occurred in the control system.</p>	<p>This is normally caused by a poor battery connection. Check the connections to the batteries.</p>
<p>7 LED+ S</p> 	<p>1. Poor connection to connector.</p>	<p>Check the cable connections between the control box, seat electronics and bottom electronics.</p>
	<p>2. Cable broken</p>	<p>Replace cable.</p>
<p>Actuator Flash</p> 	<p>1. Electrical function fault.</p>	<p>Check whether one of the electrical functions is working, check the connections from the electronics of the actuator that does not work.</p>

* If the programme has been changed, it could be the opposite motor.

PRE-SALE INFORMATION

A: If you find that the font size in the printed version of the user manual is difficult to read, the user manual is available in large font in an electronic version of this manual and is available from ROLTEC upon request. You can then enlarge the PDF file on the screen using the zoom function.

B: ROLTEC's electric wheelchairs are designed for people who have a walking disability, but whose sight, physical and mental capacity enables them to use an electric wheelchair.
MAX. User weight 130 kg.

C: ROLTEC's electric wheelchairs are designed for use indoors as well as outdoors. Please take care in narrow passages when using the wheelchair indoors, e.g. when going through doors and entrances, and when using lifts, ramps, and so on.

D: ROLTEC Viper is a class B wheelchair

E: Measurements: ROLTEC Viper: 630 mm width, 360 mm height without seat, 970 mm length.

F: Tray width: 630 mm

G: Max. safe incline: ROLTEC Viper: 6°

H: MAX Height of kerb: ROLTEC Viper: in front: 7 cm and behind: 5 cm.

I: No removable parts will have a negative effect on the wheelchair.

J: Standard for ROLTEC Viper: electric lift, electric tilt and electric back rest.

K: ROLTEC Viper can be used with air tyres or solid tyres on the drive wheel and solid tyres on the flywheels.

L: There is no programmable unit mounted on the chairs. The chairs should only be programmed by authorised technical staff.

N: Theoretical continuous driving distance: 40 km. The distance will be reduced if the wheelchair is frequently used on slopes, uneven terrain or to mount kerbs, etc.

O: Wheelchairs are not designed to be taken apart, for transportation or storage.

P: Wheelchairs are not designed to be taken apart.

Q: If the batteries are to be removed for transportation, see "Access to the battery room"

R: The wheelchair can be used as a seat in a motorised vehicle.

S: If the wheelchair is to be used as a seat in a vehicle, it should be secured with a 4-point tie-down system with hooks or via a Dahl Docking Station, see "Transportation by car"

Data:

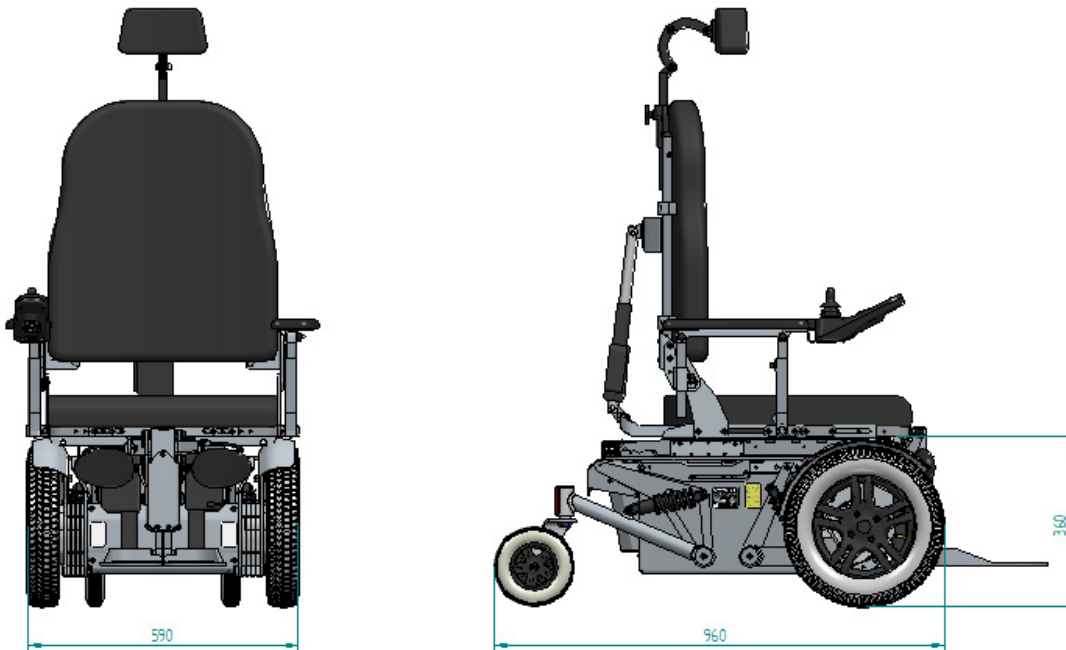

FWD:

Wheelchair type: Class B

Class B Wheelchair designed for both limited indoor use and outdoor use.

Measurements:

Length without leg supports FWD: 97 cm.

Total width with 3.00 x 8" (chassis): 63 cm

Seat mounting height: 36 cm

Free height above floor: 8 cm

Weight:

Maximum person weight with standard electric lift system: 130 kg

Total weight of the wheelchair incl. batteries without seat and foot supports: 120 kg
(depending on configuration)

Weight of 2 x batteries (Exide, 51Ah/C20): 39 kg

Temperature range:

Storage temperature: - 40 deg. C. to + 65 deg. C

Operating temperature: - 25 deg. C. to + 50 deg. C

Lights: Diodes

Batteries:

Size of battery 50 Ah: L: 306 mm B: 175 mm H: 190 mm

Batteries must not be disposed of as general waste. They should be recycled.

Maximum charging current: 12 Ah

Motors: 2 items at 24V / 400 W

Drive data:

Max. driving distance with 50 Ah batteries: Approx. 40 km at 8 km per hour

Max. driving distance with 50 Ah batteries: Approx. 30 km at 12 km per hour

Maximum speed FWD, forwards, approx.: 13 km/h

Maximum speed FWD, in reverse, approx.: 6 km/h

Required clearance for turning FWD: radius 67 cm.

Static stability downhill, uphill and horizontally: 9°

Dynamic stability uphill: 6°

Maximum incline to the sides and backwards and forwards with seat lift in top position or maximum seat tilt: 6°

Ability to take kerb without run-up forwards: 7 cm.

Ability to take kerb without run-up in reverse: 5 cm.

The wheelchair may cause interference with alarms that use electromagnetic fields. These alarms are found in particular in stores with anti-theft protection.

The wheelchair is modular and can therefore be adapted to the individual user. All of the wheelchair's electrical functions can be operated via buttons on the control box and the control stick.

The wheelchair is supplied with air-filled tyres on the large wheels as standard, but puncture-resistant wheels can also be fitted.

For predominantly indoor use, it is recommended that ribbed grey tyres are used, as these do not track dirt in from outside, and do not leave rubber marks on the floors either. If the wheelchair is used mainly outdoors, it is recommended that a rough-tread driving wheel is used.

Air pressure in tyres: 223 - 284 Kilo Pascal = 2.23 - 2.84 Bar = 32 - 40 PSI.

Front positioning of arm rest, 0 - 435 mm.

Distance from arm rest to seat (cushion), 180 - 350 mm.

Underarm angle to seat surface angle, 90 ° - 180 °

Distance from foot rest to seat (+cushion), 280-460 mm.

Back length, 500-680 mm

Back rest angle, electric 90 ° -135 °

Seat height (+cushion), 360 - 720 mm.



Effective seat width, 400-500 mm

Effective seat width, 380-550 mm

Seat angle, -7 ° -40 °

Minimum braking distance from max. speed, 2,800 mm

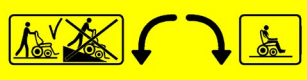
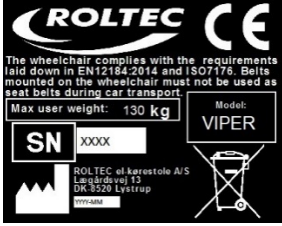
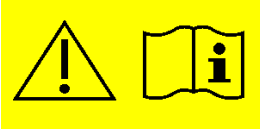
Explanation of labels/stickers on electric wheelchair

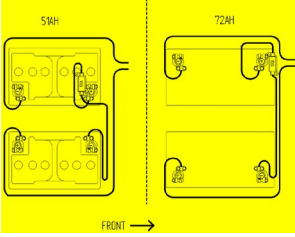
<p>Push function</p>  <p>Viper_LABEL0001</p>	<p>Identification label</p>  <p>Viper_LABEL0002</p>	<p>Read the user instructions</p>  <p>should be disposed of as electrical waste, Viper_LABEL0003</p>
<p>Transportation safety devices can be fitted</p>  <p>Viper_LABEL0004</p>	<p>Warning of personal injury - Do not place your hands or arms in between the components</p>  <p>Viper_LABEL0005</p>	<p>Battery label with diagram</p>  <p>Viper_LABEL0006</p>

New labels can be ordered by contacting ROLTEC.

Spare parts and accessories

Spare parts and accessories should be ordered from the ROLTEC dealer. The wheelchair's expected life span is approx. 8 years, depending on use. The product's life span depends on the frequency of use, the application environment as well as the care of the product.

Components that are included in the supply

A solid base, charger, leg supports, control box, back rest, seat cushion, arm rest and head restraint.

RESERVATIONS FOR CHANGES TO THE SPECIFICATIONS as a large selection of optional extras and accessories are available. There may therefore be different components to the chair.

The chair is supplied ready-assembled and ready to use, but the USER MANUAL MUST ALWAYS BE READ BEFORE THE WHEELCHAIR IS USED.

This user manual has been drawn up in compliance with current regulations.

As ROLTEC el-kørestole A/S undertakes ongoing product development, we reserve the right to make changes.



ROLTEC el-kørestole A/S

Lægårdsvej 13

DK - 8520 Lystrup

Telephone +45 87 43 49 00

Fax +45 87 43 49 29

Website: www.roltec.com

E-mail: info@roltec.com