



WOLTURNUS

User's Manual

For W5, Tukan, Dalton &
Gitano



Wolturnus A/S recommends that you read this manual before using the wheelchair.

1. Introduction	4	7. Accessories and Equipment	26
1.1 Foreword	4	7.1 Push handles	26
1.2 Intended use	4	7.2 Wing Back multi-adjustable back system	26
1.3 Usage	5	7.3 Wheel locks	27
1.4 Service	5	7.4 Stick holder	27
1.5 CE compliance	5	7.5 Tipping pedal	27
1.6 Liability	5	7.6 Upgrading rear wheels, pushrims and tyres	27
1.7 Returns	6	7.7 Upgrading casters	27
2. Safety	7	7.8 Quick-release axle with tetra grip	28
2.1 Symbols	7	7.9 Quick-release axle for casters	28
2.2 Standards and directives	7	7.10 Sideguards	28
2.3 General safety instructions	7	7.11 Thermal bridge insulation for sideguards	28
2.4 Safety requirements for transport, assembly and storage	8	7.12 Expansion kit and bracket for sideguards	28
2.5 Safety requirements during use	8	7.13 Bracket for locking folded back	28
2.6 User requirements	8	7.14 Frame protectors	28
2.7 Type labels	9	7.15 Spoke protectors	29
3. Product Description	10	7.16 Calf-support straps for footrest	29
4. Delivery & Preparation	14	7.17 Bags	29
4.1 Delivery	14	7.18 Seat Cushion	29
4.2 Preparation for use	14	7.19 Straps, belts and restraints	29
5. Transport and Storage	15	8. Cleaning and Maintenance	30
5.1 Transport	15	8.1 Maintenance	30
5.2 Transfer	15	8.2 Cleaning and disinfection	31
5.3 Slopes and overcoming obstacles	16	8.3 Changing tyre	31
6. Adjustment & Set-up	17	9. Troubleshooting	33
6.1 Adjustable features	17	10. Technical Data	34
6.2 Tools	17	11. Instructions for Reuse	36
6.3 Back angle adjustment	18	11.1 Instructions for reuse	36
6.4 Adjusting back depth and form	18	11.2 Disposal	36
6.5 Adjusting back height	19	12 Environment	37
6.6 Adjusting seat length, depth and form	19	13 Manufacturer and service.	38
6.7 Adjusting armrest height	20		
6.8 Adjusting balance point	20		
6.9 Adjusting footrest height	21		
6.10 Adjusting footrest angle and position	22		
6.11 Adjusting anti-tip device	22		
6.12 Adjusting wheel locks	23		
6.13 Adjusting seat height	24		
6.14 Adjusting the rear wheels	25		
6.15 Changing caster with front fork	25		

1 Introduction

1.1 Foreword

This user manual provides users and helpers with essential information about the design, functions, use and maintenance of the Wolturnus W5, Tukan, Gitano, Dalton, Dance wheelchair for adults, throughout the rest of this manual these models will be described by the wheelchair. The manual contains the information necessary to ensure safe use of the wheelchair. It contains troubleshooting information with, where applicable, solutions.

The wheelchair is an easy-propulsion active wheelchair in high-strength aluminium. The wheelchair design makes it as easy as possible for the user to operate the chair independently. The wheelchair is custom-built according to the user's instructions. This ensures that the wheelchair precisely meets the individual user's requirements. Because the back can be folded and both the rear wheel and sideguards removed, the wheelchair is easy to transport, including in ordinary cars. The wheelchair is ideal for users who want to have an active daily life, indoors and outdoors. The amount of adjustability may vary depending on the model and ordered features.

The instructions in this manual are essential for safe and correct use of the wheelchair. Before starting to use it, it is important that both the user and helper read these instructions carefully paying special attention to the safety instructions. The information provided ensures that the user gets the optimum advantage of the wheelchair's features and functions. Visually impaired users may obtain this information by having another person read for them. Furthermore, the manual is available on www.wolturnus.dk/en/ where it is possible to enlarge the text or have the text read up by a suitable computer program. Keep this user manual throughout the lifetime of the wheelchair: It contains information that can answer future questions and it contains guidelines for adjusting and adapting the chair.

This user manual has been produced in accordance with DS EN82079-1 '*Preparation of instructions for use - Structuring, content and presentation*'. It is divided into sections. The heading on each page contains the title of the overall section. The foot of each page displays the page number, year, and site of origin of the user manual. It also includes the wheelchair model.

1.2. Intended use

The wheelchair is designed for individual mobility, indoors and outdoors. It is only suitable for people who are unable to walk or have a mobility problem, but have unimpaired sight and cognition. Only equipment that is specified in this user manual may be used with this wheelchair, and vice versa.

Wolturnus A/S does not guarantee this product if it is used with accessories or products from manufacturers other than those specified as part of the modular system.

Use of the wheelchair for any purpose other than the aforementioned will be considered incorrect. In the event of incorrect use, the user - i.e. not the manufacturer - is liable for resulting damage to persons or property.

The wheelchair may only be used by practised users. For personal protection and in order to ensure that the wheelchair is used safely and correctly, it is a requirement that the user and helpers receive training and instruction.

The wheelchair can only be used safely if it is used correctly in accordance with the information provided in this user manual. The user bears final responsibility for accident-free use.

1.3 Usage

The wheelchair's modular design and versatility make it suitable for users who have difficulty walking or who have a mobility handicap as a result of:

- Paralysis
- Loss of limbs (leg amputation)
- Limb defects or deformities
- Damaged or defective limbs
- Other illnesses

When adapting the wheelchair for the user, the following should be taken into account:

- Body height and weight (max. load 120-250 kg.)
- Physical and mental constitution
- Age
- Residential circumstances
- Surroundings

WARNING!

Risk of injury with incorrect use

To avoid the risk of getting fingers caught in the rear wheel spokes or wheel locks, and to avoid the risk of the chair tipping, children should not play with the wheelchair.

INFORMATION

The wheelchair service and repairs may only be carried out by authorised personnel trained by Wolturnus A/S. In the event of problems, please contact Wolturnus A/S

1.4 Service

In the event of questions or problems that cannot be resolved using this user manual, please contact Wolturnus A/S customer service at (+45) 9671 7170.

Wolturnus A/S strives to provide full assistance to its customers in every respect and thus to ensure total satisfaction with the wheelchair. Wolturnus A/S contact information and a list of service locations can be found in section 13.

In the event that the wheelchair requires repairs at Wolturnus A/S for an extended period of time, a courtesy wheelchair can be borrowed for that period. Please contact Wolturnus A/S for further information.

1.5 CE compliance

The wheelchair meets the requirements of European Commission Directive 93/42/EEC for medical devices. The product is classified as Class 1 on the basis of the classification criteria for medical devices in accordance with IX of the directive. Wolturnus A/S has therefore, as manufacturer with sole liability, made a declaration of conformity in accordance with appendix VII of the directive.

1.6 Liability

Wolturnus A/S' warranty applies only if the product is used in accordance with the specified circumstances, purpose and instructions. The frame is covered by a 5-year warranty. Other parts manufactured by Wolturnus

are covered by a 2-year warranty. Parts that are designed and manufactured by a third-party manufacturer and mounted on a Wolturnus wheelchair are covered by a Wolturnus A/S warranty that is equal to the warranty provided to Wolturnus A/S by the third-party manufacturer.

Wolturnus A/S is not liable for injury or damage caused by:

- Components and parts that are not authorised by Wolturnus A/S.
- Alteration to the original surface treatment.
- Repairs or alterations to the wheelchair that are not carried out by Wolturnus A/S. All warranty repairs will be carried out by Wolturnus A/S.
- Incorrect use of the wheelchair (e.g. to play basketball or rugby), or loads that exceed the construction or specified maximum for the wheelchair (in accordance with directive 93/42/EEC for medical devices).
- Circumstances in which the wheelchair is used by any party other than the original owner/user.
- Circumstances involving bad weather or dangerous situations, or in general all types of predictable negligence.
- Lack of maintenance.
- Cleaning with agents that contain acid or alkaline products, with high-pressure equipment or similar.

To keep updated about this product e.g. regarding new features, safety notice, product recalls check www.wolturnus.dk. Contact information and overview concerning all of Wolturnus's products are available at the website - or by contacting Wolturnus A/S customer service at (+45) 9671 7170.

1.7 Returns

In the event that the wheelchair has to be returned to the supplier or to Wolturnus A/S, e.g. for repairs, it should be transported in its original packaging for optimum protection. Wolturnus A/S therefore recommends that the original packaging is retained throughout the lifetime of the wheelchair.

2 Safety

2.1 Symbols

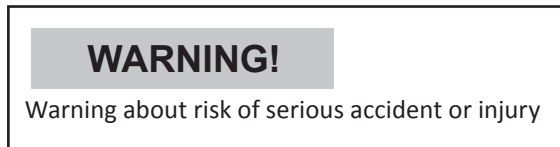

2.2 Standards and directives

All safety information in this user manual is based on applicable national laws and regulations in the EU. For other countries, a declaration of conformity with applicable laws and national regulations is required.

In addition to the safety instructions contained in this user manual, the user must be familiar with and must comply with applicable regulations from professional associations, on accident prevention and on environmental protection. All information contained in this user manual must be complied with at all times without limitation. The wheelchair is constructed in accordance with applicable regulations. The wheelchair safety level is approved by CE certification and a declaration of conformity.

2.3 General safety instructions

- The Active wheelchair must only be used correctly.
- The Active wheelchair must only be used by trained users and must not be used by any other person than the user.
- The Active wheelchair must only be used to transport one person.
- All safety instructions in this user manual and all other relevant documentation must be kept and complied with throughout the lifetime of the chair. The user manual must always be available to the user.
- The back and seat upholstery have passed the demanded tests for ignition, so they are fire-resistant. Nevertheless extreme care should be taken when in the vicinity of flammable items and fire, including, for example, lighted cigarettes.
- To avoid discomfort when using the chair, damaged back or seat upholstery should be replaced as soon as possible.
- Do not force the chair over obstacles when using it on hills and slopes.
- The wheelchair must not be used on stairs.
- Avoid getting in or out of the chair while on hills or a slopes.
- The hip strap (accessories) gives the user extra stability. It must never be used as part of the strap attachment system when securing the chair for transport in a vehicle.
- Do not force the wheelchair along on hills or slopes of greater than 7°.
- Do not park on hills or slopes of greater than 7°, not even with the wheel lock activated.

2.4 Safety requirements for transport, assembly and storage

- Only suitable lifting mechanisms may be used when transporting the wheelchair.
- The wheel locks must be applied when transporting with a lifting platform in situations where the chair must be stationary, e.g. in lifts, buses, trains etc.
- The wheelchair must, to the degree possible, be placed in the middle of the platform and all components, e.g. the anti-tip device, must be clear of any area where there is a risk of them being caught during transport.
- When adjusting and adapting the chair, all attachment features, e.g. screws and nuts, must be fastened according to instructions.
- For transport in vehicles we recommend that, whenever possible, the user is transferred to the vehicle's own seats and uses the vehicle's own safety belts. If this is not possible, and the user therefore must remain in the chair, there must be an approved, mounted docking system in the vehicle.

2.5 Safety requirements during use



- The user and helpers must always ensure that the chair and its safety features are in proper and safe condition before using the chair.
- The Active wheelchair must be inspected by a Wolturnus-authorized specialist at least once every year in order to ensure that the chair is in proper working order and safe to use.
- The chair must immediately cease to be used if any feature is defective or not operational or if any other circumstance arises which could lead to injury.
- Before starting to use the Active wheelchair, all mechanical adjustments (positioning the seat, accessories, etc.) must be carried out in accordance with the user's individual requirements and abilities. These adjustments may only be carried out by Wolturnus-authorized specialists.
- Depending on the model, the maximum load for the active wheelchair is 120-250 kg. It must not be exceeded.
- The wheelchair tyres must be inspected visually before use to ensure that there is sufficient tread depth and correct tyre pressure. The correct pressure is printed on the tyre.
- When used on public roads, the user must obey applicable traffic rules.
- The wheelchair should not be used on slippery surfaces (e.g. ice) or on very rough terrain (e.g. on gravel or small stones).
- When getting in and out of the wheelchair, the user's full weight should not be placed on the footrest or armrests. These cannot bear full body weight.
- Only change direction at reduced speed.
- The wheelchair must only be lifted by gripping the frame parts. Do not grip the footrest or armrests to lift the chair.
- The wheelchair must not be exposed to extreme temperatures, to high humidity or to environments with chlorine (e.g. in saunas or at swimming pools).
- The wheelchair's surface temperature can raise if it is exposed to high heat, e.g. in strong sunlight for an extended period of time. There is also a risk of too low a surface temperature in the event of extreme cold.
- The anti-tip device should be used when travelling on uneven terrain or where there is a hurdle, e.g. on slopes. New users are advised to always use the anti-tip device.
- Never place fingers between the rear wheel spokes or between the rear wheel and the wheel locks. Caution is advised when travelling through narrow passages.

2.6 User requirements

- Before starting to use the wheelchair, the user and any helpers must read the user manual thoroughly and be familiar with its contents.
- The Active wheelchair must only be used by trained users. To ensure this, the user and any helpers will receive instruction in use of the chair from Wolturnus-authorized specialists.

2.7 Type Labels

A type label is attached to the wheelchair. The type label includes the following information:

	Caution
	The wheelchairs year of production
	Read the user's manual before using the wheelchair

The type label is placed on the cross tube under the seat facing forward as shown on image 1.

See the user manual car-fixation, for information about safety and labels for fixation in vehicles. Label for car fixation is shown on image 1.



Image 1 Location of type labels, anti-tip warnings, and restraining points

3 Product description

The wheelchair is a robust Active wheelchair that is made to suit your measurements and individual requirements. The wheelchair is suitable for experienced and active users who know their own requirements. It is suitable for users who need to continually adjust the seating position. The wheelchair is available with a fully-welded back and back axle and as an adjustable model.

A fully-welded the wheelchair has no moving parts. It is extremely rigid and robust, which means that all your energy is harnessed for propulsion. The adjustable the wheelchair is designed to meet life's changing challenges. For example, options include an adjustable back axle; angle and height-adjustable back; angle and height-adjustable footrests; and detachable sideguards. All of these make it a wheelchair that is easy to adjust and easy to stow in a car.

Because the wheelchair has a modular design, additional equipment and accessories, e.g. a Wing Back support system, can be purchased and retrofitted. A range of accessories is described in section 7. The entire range of accessories, spare parts and additional equipment can be seen at the Wolturnus A/S web shop www.wshoppen.dk.



Image 2 The W5 Active wheelchair

W5 SERIES



W5 - Light and hard-wearing for active users

- › Robust with rigid back and rear axle.
- › User weight max 170 kg.



W5 A - Adjustable model

- › Fully adjustable or with optional adjustability
- › User weight max 140 kg



W5 S - Elegant and easy to stow in a car

- › Arched frame tubes between castors and wheels
- › Rigid back and rear axle; user weight max 140 kg



W5 SA - Elegant, adjustable, easy to stow in a car

- › Fully adjustable or with optional adjustability
- › Arched frame tubes between castors and wheels
- › Easy to stow in a car; user weight max 140 kg



W5 SL - Light and elegant rigid wheelchair

- › Low weight (from 6kg)
- › User weight max 80kg
- › Single-sided fork



W5 D - With flip-up footrests

- › Fully adjustable or with optional adjustability
- › Separate flip-up footrests for easy access
- › User weight max 140 kg



W5 XXL - Reinforced for larger users

- › Fully adjustable or with optional adjustability
- › Reinforced frame and rear wheels; pneumatic tyres
- › User weight max 250 kg



W5 K - For users with short leg length

- › Fully adjustable or with optional adjustability
- › High-mounted footrest for short lower leg length
- › User weight max 140 kg

Tukan- Strong and elegant for an active life

- › Robust with fixed back and rear axle
- › User weight max. 120kg



Tukan A - Robust with optional adjustability

- › Fully adjustable or with optional adjustability
- › User weight max. 120 kg



Dalton - With multifunctional footrest

- › Fully adjustable or with optional adjustability
- › User weight max. 160 kg

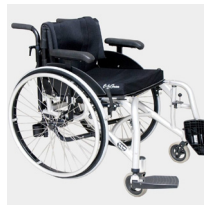

Dalton L - With low seat for walking the chair

- › Fully adjustable or with optional adjustability
- › User weight max. 160 kg



Dalton F - Front wheel driven

- › Fully adjustable or with optional adjustability
- › User weight max. 160 kg



Gitano - For very active users

- › Rigid and robust and light
- › For experienced users who know their requirements
- › User weight max 130 kg



TUKAN
SERIES

DALTON
SERIES

GITANO
SERIES

4 Delivery and preparation for use

4.1 Delivery

Delivery covers:

- Active wheelchair with main components
- User manual
- Selected accessories (Accessories range: see section 7)

INFORMATION

The range of accessories are determined by the product configuration that the user chooses when ordering the wheelchair.

CAUTION!

The wheelchair may tip over. Wolturnus recommends to use the anti-tip device at all times.

Wolturnus A/S delivers the wheelchair ready for use. All configurations that are part of the order have been made or will be made upon delivery by the supplier or a consultant. The Active wheelchair is adapted to meet the user's personal wishes and requirements.

The wheelchair's functions can be tested by following the instructions in section 6.

Troubleshooting: See section 9.

4.2 Preparation for use

Before starting to use the Active wheelchair, it must be inspected to ensure that it is complete (image 3) and that all functions are in proper working order. Wolturnus A/S delivers the Active wheelchair ready for use.

Main components (image 3):

1. Frame with back support and seat
2. Rear wheel
3. Caster
4. Sideguards with/without armrest
5. Wheel locks
6. Footrest
7. Anti-tip device
8. Push handle

Brakes Cushion Sideguards Push handles



Image 3. Main components

5 Transport and storage

5.1 Transport

For transport or storage, the rear wheels can be removed and the Active wheelchair folded. This makes it easy to handle and saves space:

- Remove the sideguards or fold them down into the seat, depending on mounting method.
- Tip the back into the folded position, if the wheelchair is with folding back.
- Remove the rear wheels by pressing the Quick-release axle in the wheel nave and pulling the wheel off.

Without the user, the wheelchair is suited for land and air transport. During storage, the Active wheelchair should be kept in a dry place and not exposed to damp. For long-term storage, the wheelchair should be covered to protect it from dust. After transport or storage, mount the rear wheels, fold up the backrest, and mount the sideguards. Before use after long-term storage, complete the actions described in section 8.1 about maintenance.

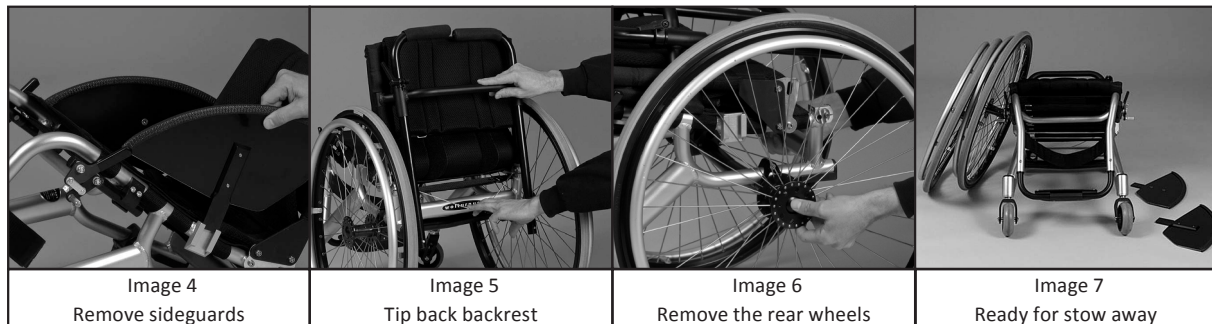

5.2 Transfer

Method of transfer to and from the wheelchair is individual as best suits the user. The most common method is transfer from the side or front.

The following description is based on transfer without third-party help and from one wheelchair to another.

- Place the wheelchair beside and as close to the other seating surface as possible at a 90° angle.
- Apply the wheel locks. When transferring to another wheelchair, apply the wheel locks on both chairs.
- Move feet from the footrest and place on the ground.
- Move from the chair to the other seat. The method of actual transfer will vary from user to user. Use the method that works best.

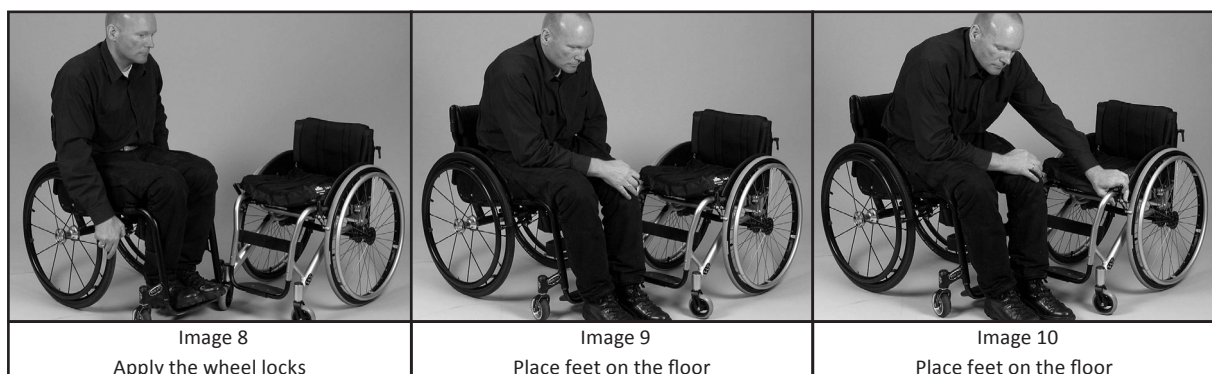

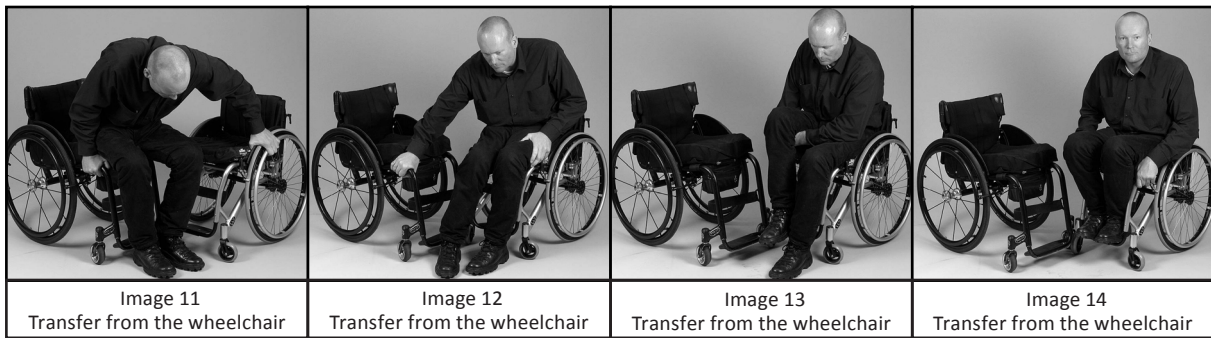

When transferring for the first time and until the user gets used to transferring, it is recommended to have a helper present.

CAUTION!

Risk of damage due to overload.

When getting in and out of the chair, the user must not place full body weight on the footrest or armrests.

CAUTION!

The wheel locks must be applied during transfer.

5.3 Driving over slopes and obstacles

When using the Active wheelchair, situations may occur where driving on slopes and crossing obstacles is necessary, such as:

- Driving up and downhill (image 15 og 16) .
- Driving over steps and curbs (image 17).
- Passage of obstacles greater than what the wheelchair user can climb on his own, use a ramp (image 18).

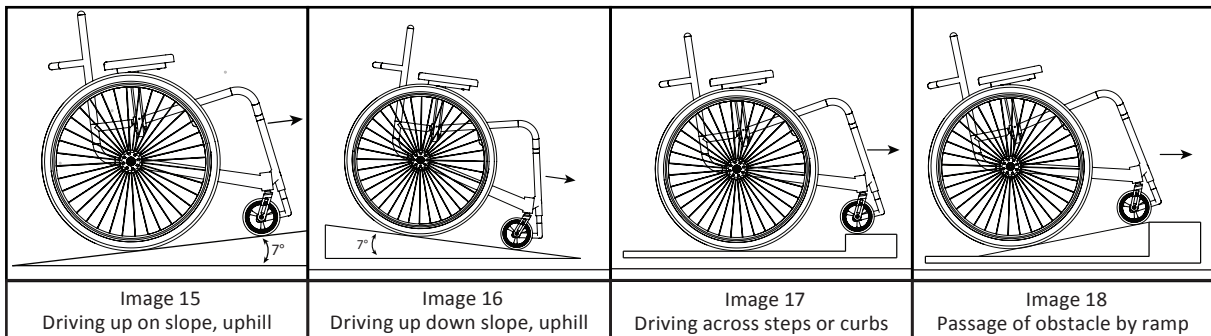

CAUTION!

Lean body forward when driving on slopes or passing obstacles, and get support from behind.

WARNING!

Danger when pushing wheelchair incorrectly

Adjust push handles to fit obstacles.

CAUTION!

Always pass obstacles with a direct forward motion (at an angle of 90 degrees). Lift wheels over steps and curbs.

WARNING!

Danger when pushing passing obstacles without assistance.

Always have assistants when passing obstacles.

6 Adjustment and set-up

6.1 Adjustable features

CAUTION!

Risk of accident due to loose screws

After loosening threaded screws, they must be replaced with new screws or secured again with a medium-strength thread paste (e.g. EuroLock A24.20). After making adjustments to the wheelchair, screws and nuts must be tightened correctly.

The wheelchair can be adjusted in various ways.

When delivered, the height, width and angle of the seat and the back have been positioned in accordance with the customer's order as received by Wolturnus A/S.

The following can be adjusted by the user:

- Back height, depth and angle
- Seat height, depth and angle
- Armrest and arm cushion
- Balance point position
- Footrest height and angle
- Anti-tip device height
- Wheel lock position
- Change of caster and front fork

6.2 Tools

The following tools (image 19) are necessary for adjustments and settings described in this section:

- 3 mm Allen key (1)
- 4 mm Allen key (1)
- 5 mm Allen key (1)
- 6 mm Allen key (1)
- 8 mm single-head wrench (2)
- 10 mm single-head wrench (2)
- 13 mm single-head wrench (2)
- 19 mm socket wrench
- Wrench (3)
- Measuring tape (4)
- A bubble level (5)

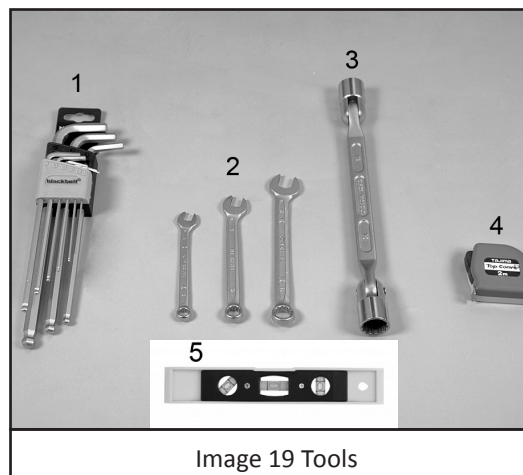

NOTICE

Damaged tools or incorrect use of tools can result in injury or in damage to the chair.

6.3 Back angle adjustment (only apply for folding back)

The angle of the folding back can be adjusted to attain the best possible position for the user.

- Fold the back down so that the bolt which secures the back is accessible (image 20).
- Loosen the nut at the bottom of the back tube with a 13 mm single-head wrench.
- Use a 6 mm Allen key to adjust the bolt. To angle the backrest further back, screw the bolt higher up the back tube. To angle the backrest further forward, screw the bolt lower down the back tube.
- Tighten the nut (Tension 10 Nm/7,4 ft.lbf/88 in.lbf.).
- Complete this process on both sides. To avoid a lopsided backrest, make sure that the bolts are screwed in place at equal heights on the back tube.

The eccentric lock must also be adjusted (doesn't include the light style folding back);

- Use a 5 mm Allen key to loosen the bolt (image 21).
- Adjust the lock until it slides into position in the lock pawl.
- Tighten the nut (Tension 10 Nm/7,4 ft.lbf/88 in.lbf.).

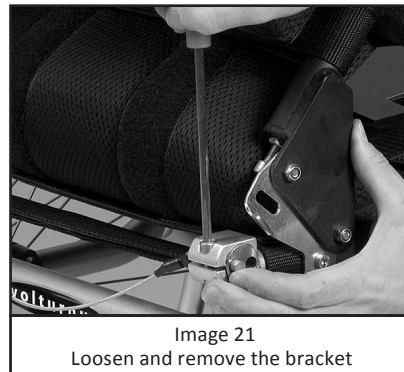

WARNING!

When the back has been adjusted, the wheelchair's point of gravity may have shifted, which may create a risk of backward tipping. Therefore, after adjusting the back, check the point of gravity and, if necessary, adjust it before using the chair (See section 6.9).

WARNING!

Ensure that the back angle has been adjusted equally on both sides and that, after adjustment, the back locks correctly into place both when upright and folded.

6.4 Adjusting back depth and form

The back's form can be adjusted to suit the individual user's requirements for support and balance. The Velcro straps under the back upholstery are used to adjust it.

- Fold up the back of the backrest upholstery so that the Velcro straps are visible (image 22).
- Loosen or tighten individual straps so that the back's form suits the user's requirements (image 23).
- Fold down the back upholstery and secure it to the straps.

Adjustment of the back form and depth greatly affects the benefit the user gets from the chair. Wolturnus A/S recommends that form and depth are initially adjusted with assistance from a Wolturnus A/S consultant or from the user's therapist.



Image 22
Fold the back of the upholstery



Image 23
Loosen and tighten the straps

WARNING!

When the seat and/or back upholstery straps have been adjusted, the wheelchair's point of gravity may have shifted, which may create a risk of backward tipping. Therefore, after adjusting the seat and/or back upholstery, check the point of gravity and, if necessary, adjust it before using the chair. (See section 6.8).

6.5 Adjusting back height (only height-adjustable back)

- The back height can be steplessly adjusted to meet requirements.
- Remove the back upholstery and top.
- Press the spring lock in and either raise or lower the height bar for the back.
- To adjust the height even further, the height bar can be removed and reversed (image 25).
- Mount the back upholstery and top again.

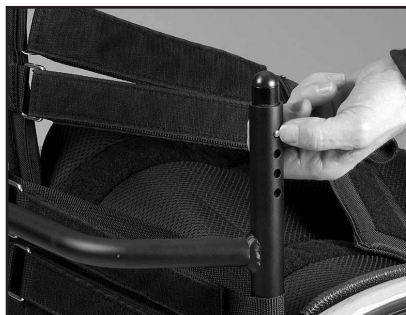

Image 24
Press the spring lock in



Image 25
For further height adjustment

6.6 Adjusting seat length, depth and form

When delivered, the seat length has been adjusted according to the measurement provided in the customer order, but it can be adjusted as required.

- Remove the seat cushion and loosen the Velcro that holds the front and rear section of the seat cover together (image 26).
- Push or pull the front section into the desired position (image 27).
- Attach the front section of the seat cover to the rear section, then mount the cushion.

Seat depth and form can also be altered, instructions are described below:

- Remove the seat cushion and the front section of the seat cover (image 28).
- Adjust the Velcro straps on the rear section of the seat cover by tightening or loosening them to meet the user's requirements (image 29).
- Mount the front section of the seat cover and tighten the Velcro strap at the front.
- Mount the seat cushion.

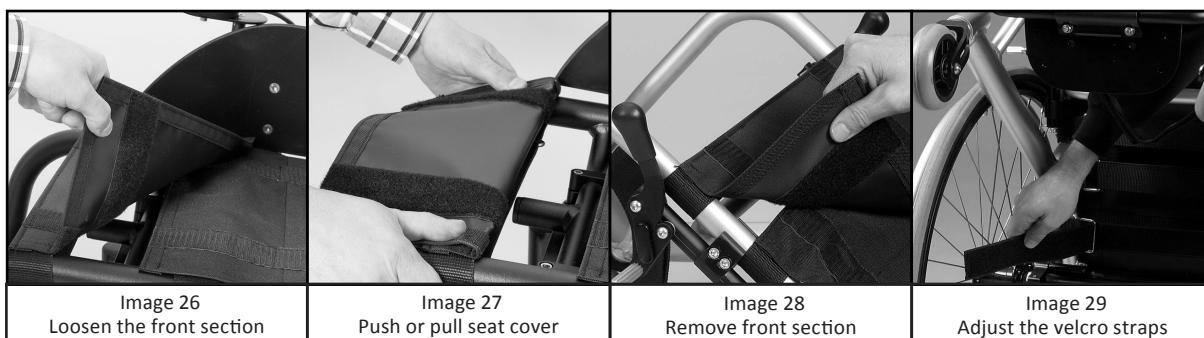

WARNING!

During strap adjustment of the seat and/or back upholstery, the wheelchair's point of gravity may have shifted, which may create a risk of backward tipping. Therefore, after adjusting the back, check the point of gravity and, if necessary, adjust it before using the chair. (See section 6.8).

INFORMATION

Notice; tightening the straps towards the front seat edge, not the back edge, will benefit some users. This creates a counterpoint for the back support's forward pressure on the lower body and a better hip position. Wolturnus A/S recommends that this is done with assistance from a Wolturnus A/S consultant or the user's therapist.

6.7 Adjusting armrest height

- Remove the armrest (image 30).
- Use a 4 mm Allen key to unscrew the side panel from the baluster (image 31).
- Mount the side panel on the baluster at the desired armrest height.
- Mount the armrest on the wheelchair.

Repeat the process as necessary to achieve the correct armrest height.



Image 30
Remove the armrest

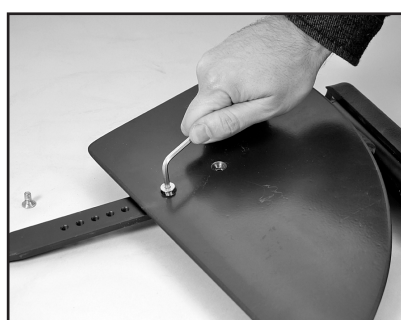

Image 31
Unscrew the baluster

6.8 Adjusting balance point with adjustable rear axle

The wheelchair's point of gravity and stability can be changed by moving the rear axle forward or backward. By moving the rear axle and therefore the rear wheels forwards, the load on the casters is lightened. It is therefore easier to tilt the wheelchair up on the rear wheels. Practised users will find this makes the wheelchair easier to manoeuvre. Moving the rear axle backwards makes it harder for the chair to tilt up on the rear wheels. The distance between the casters and the rear wheel is increased, which increases stability during propulsion.

Adjusting the rear axle:

- Use the Quick-release mechanism to remove the rear wheels (image 32).
- Move the wheel locks forward so that they are not in the way when the rear wheels are remounted. After adjusting the rear axle the wheel locks must be adjusted so that they are positioned correctly before use
- Use a 5 mm Allen key to loosen the three bolts on the bracket that fastens the rear axle to the frame. Loosen them enough to allow the rear axle with console slide back and forward on the frame (image 33).
- Find the desired position. Use a slide rule or ruler to check that the distance between the rear axle and the back edge is equal on both sides (image 34).
- Use a 5 mm Allen key to tighten the bolt with a torque wrench. (Tension 10 Nm/7,4 ft.lbf/88 in.lbf.)
- Mount the rear wheels and adjust the wheel locks as described in section 6.12 (image 35). Make sure the Quick-release mechanism is locked correctly; it audibly clicks when correctly in place.

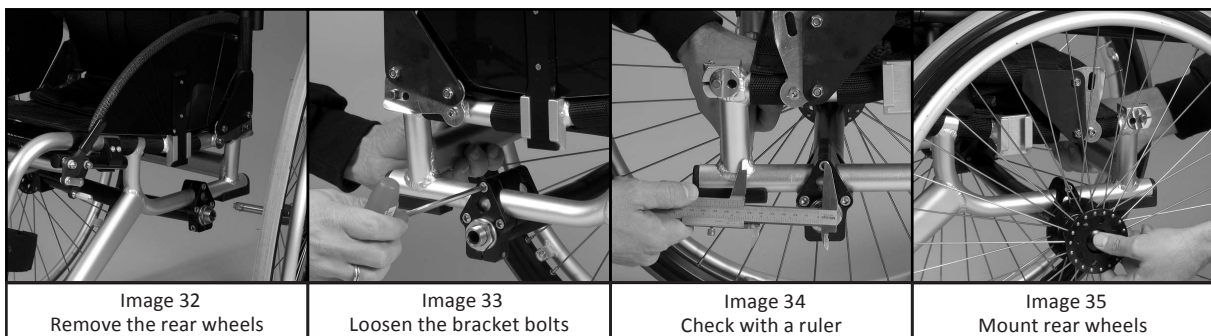

CAUTION!

To prevent the wheelchair unintentionally tipping backwards, it is recommended that the user always gets a helper to stand behind the wheelchair while trying out balance point adjustments.

6.9 Adjusting footrest height

- Use a 3 mm Allen key and an 8 mm wrench to loosen and remove both nuts at the back of the front-frame (image 36).
- Remove the Allen key so that the footrest can freely slide within the front-frame tube.
- Raise or lower the footrest to the desired height, making sure that the holes in the footrest and the front-frame match. Make sure that the footrest is not lopsided.
- Mount the clamps and nuts and tighten them (Tension 4 Nm/3,0 ft.lbf/35 in.lbf). If tightened too much, the frame could bend (image 37).

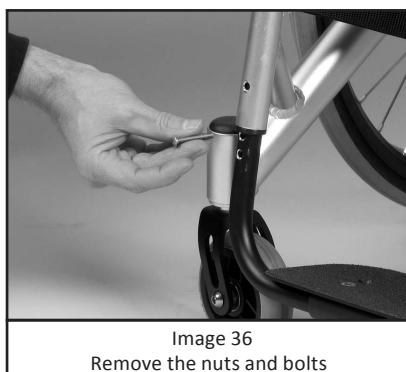

6.10 Adjusting footrest angle and position

- Use a 4 mm Allen key and 10 mm single-head wrench to loosen the nuts on the bracket underneath the foot plate (image 38).
- Turn the foot plate until it is at the desired angle (image 39).
- Tighten the nuts.

The foot plate itself can be adjusted and moved further back or forward.

- Use a 4 mm Allen key and 10 mm single-head wrench to loosen the bolts on the foot plate, then remove it (image 39).
- Mount it in the second set of foot plate notches.

The bracket itself can be reversed so that the holes are positioned to the front of the foot brace. The foot plate can then be moved further forward.

- Pull the bracket to the right until the footrest joint is visible.
- Push the left section away so that the bracket can be removed (image 40).
- Reverse the bracket and repeat the process in reverse order. Mount the footplate (image 40).

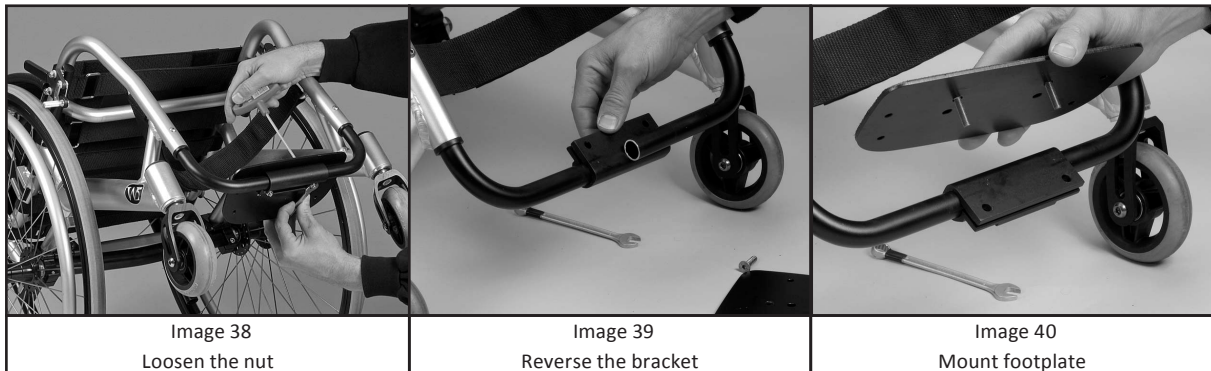

CAUTION!

Never place full body weight on the footrest

6.11 Adjusting anti-tip device

When extended, the anti-tip device prevents the wheelchair from tipping backwards. When making adjustments that can affect the balance point and distribution of weight, the anti-tip device should be extended.

- The height of the anti-tip device can be adjusted by loosening the bolts with a 5 mm Allen key (image 41).
- When it is at the correct height, tighten the bolts.

Standard height from floor to anti-tip device wheel: 6 cm (image 42).

- The length of the anti-tip device can be adjusted by loosening the three bolts on the bracket that mounts the device to the back axle (image 41). Be careful not to alter the position of the back axle as this would affect the balance point.
- When the desired length has been attained, tighten the bolts (Tension 10 Nm/7,4 ft.lbf/88 in.lbf.).

CAUTION!

Never use the anti-tip device as a tipping pedal. If used as a tipping pedal, the anti-tip device's spring function could be damaged. This would make the anti-tip device defective and put the user at risk.

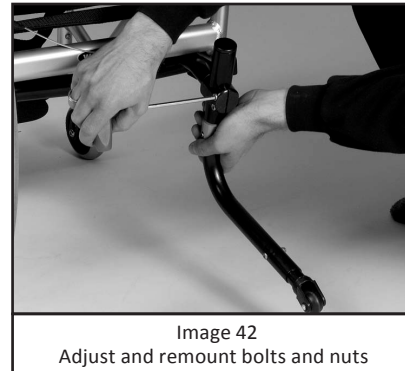
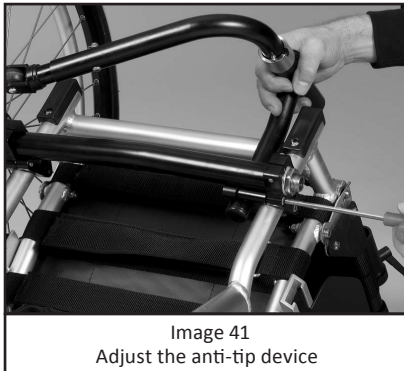

6.12 Adjusting wheel locks

The wheelchair is supplied with push wheel locks as standard. The push wheel locks are activated by pressing forwards and can be operated by the user. The push wheel locks are mounted on the wheelchair frame. Other types of wheel locks are mounted in the same way, so the following adjustment instructions can also be used for them.

If the balance point and therefore the position of the rear wheels is changed, or if the wheel size is changed, the wheel locks must be moved and adjusted at the same time. The wheel locks must be moved forward before changing the balance point or rear wheels. After adjusting the balance point or changing the wheels, the wheel locks must be correctly adjusted.

Before adjusting the balance point or changing wheels:

- Use a 5 mm Allen key to loosen the two bolts in the console that fastens the wheel locks to the front-frame (image 43).
- Move the wheel locks forward and lightly tighten the console so that they are not in the way.

After adjusting the balance point or changing wheels:

- Loosen the wheel locks.
- Move them backwards so that the brake pad, when activated, presses sufficiently on the tyre to ensure that the wheelchair is properly locked. As a rule, the brake pad should press the tyre at least 5 mm (image 44).
- Tighten the bolt. Mount the axle and bolts. (Tension 10 Nm/7,4 lbf/88 in.lbf.)

It is important that the left and right wheel locks have the same position. Use a slide rule or measuring tape to check that the wheel locks give the same degree of friction when activated.

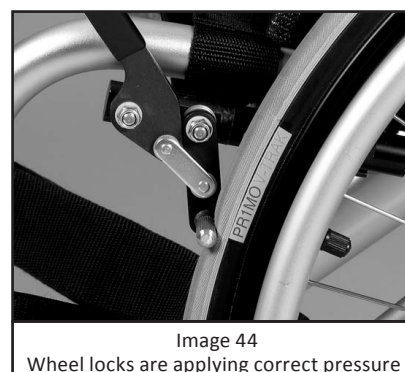
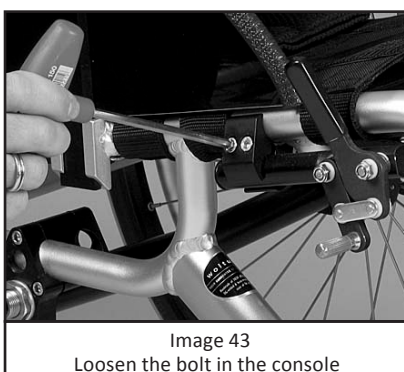

CAUTION!

Ensure the correct tyre pressure. Ensure the tyres have the correct pressure before using the chair again. The maximum air pressure limit is marked on the side of the tyre. It must always be minimum 3.5 bars (350 kPa) on rear wheels. Like push wheel locks, knee-lever wheel locks are only effective when air pressure is sufficiently high and when they are correctly positioned. (When locked, the brake pad should push the tyre in 5mm (allowing for technical alterations)).

Using the push-action wheel locks

1. Activate the wheel lock by pushing the handle forward (image 45). The wheel is now secured by the wheel lock.
2. Deactivate the wheel lock by pulling the handle backwards (image 46). The wheel is free of the wheel lock.

Using the scissor wheel locks, small

1. Activate the wheel lock by pushing the handle back towards the wheel (image 47). The wheel is now secured by the wheel lock.
2. Deactivate the wheel lock by pulling the handle away from the wheel (image 48). The wheel is free of the wheel lock.

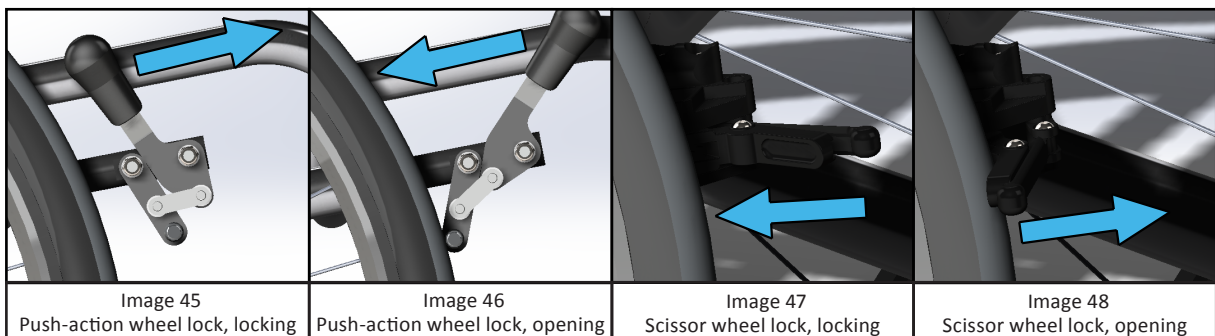

WARNING!

Incorrect use of the wheel lock

Never use the wheel locks as driving brakes. Always engage wheel locks in both sides. Check that the wheel locks are adjusted as advised.

6.13 Adjusting seat height

Seat height can be adjusted by changing to a larger or smaller rear wheel or front caster.

Both must be changed. If only one is changed, the original seat angle will be altered. If the wheelchair has an adjustable back axle, the height of the back axle can be adjusted and this will adjust the seat height to the rear.

For advice on seat height adjustment, contact your nearest Wolturnus A/S sales consultant or distributor. Contact information: see section 13.

WARNING!

During adjustment of the seat height and/ or angle, the wheelchair’s point of gravity may have shifted, which may create a risk of backward tipping. Therefore, after adjusting the back, check the point of gravity and, if necessary, adjust it before using the chair. (See section 6.9).

6.14 Adjusting the mutual distance of the rear wheels

- The distance between the rear wheels can be increased or decreased as required.
- Remove the rear wheels.
- Use a 27 mm single-head wrench to loosen the nut on the back axle bushing (image 49).
- Screw the bushing itself in (narrower distance) or out (wider distance) (image 50).
- Tighten the nut (Tension 50 Nm/7,4 ft.lbf/88 in.lbf.).
- Repeat the process on the opposite side. Make sure that the bushing is screwed in or out by an equal amount on both sides. Make sure to check the brake position before using the wheelchair again.

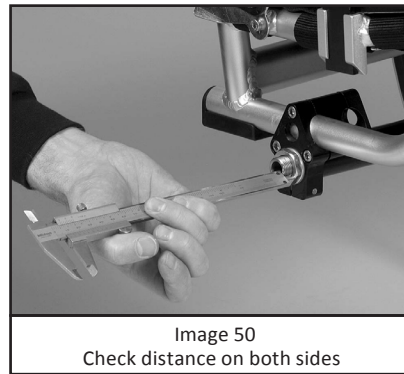
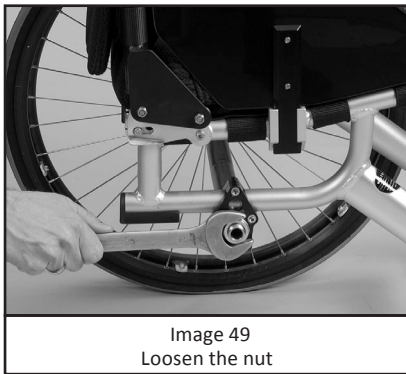

6.15 Changing caster with front fork

- Carefully loosen the bearing housing cap in the casing with a slotted screwdriver (image 51).
- Use a 19 mm socket wrench to remove the nut (image 52).
- Pull out the fork with caster and push the new one into place (image 53).
- Tighten the nut. Do not tighten the nut too much; it must still be possible to rotate the front fork easily in the caster casing.
- Put the bearing housing cap back on. (Tension min. 10 Nm/7,4 ft.lbf/88 in.lbf.) (image 51).

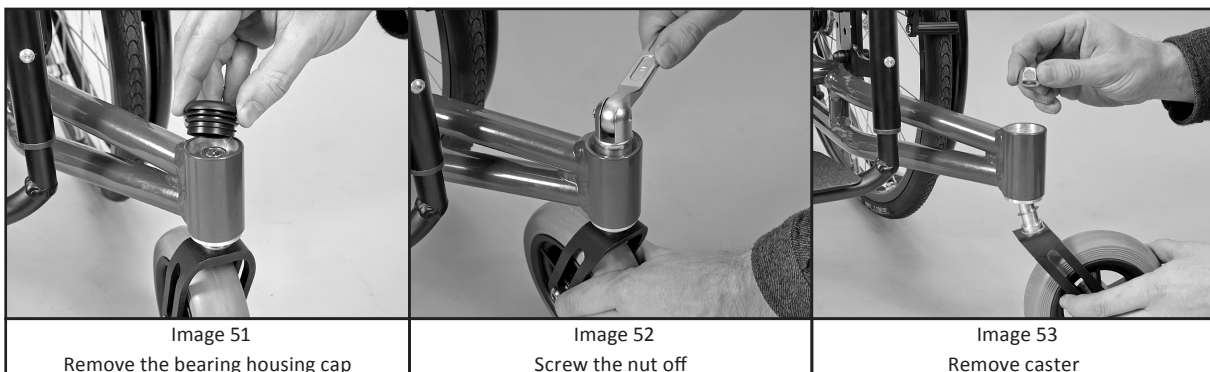

7 Accessories and equipment

A wide range of accessories and equipment is available for Woltornus Active wheelchairs. The most popular accessories are described in this section. The full range of accessories and order information are available at the Woltornus A/S website www.woltornus.dk/en/products/.

7.1 Push handles

Height-adjustable push handles (image 54)

Height-adjustable push handles can be chosen when ordering the wheelchair or purchased subsequently for retrofitting. Retrofit options will depend upon the chosen back configuration. For advice about retrofitting, contact your nearest Woltornus A/S sales consultant or distributor. Contact information: see section 13.

Push handles med Quick-release (image 55)

Quick-release push handles are mounted on the back column with a console. The push handles can be removed from the console by using the Quick-release device.

Foldable push handles (image 56)

Push handles that can be folded can be mounted either at the top of the back tubes or on an extra tube. Retrofit options will depend upon the chosen back configuration. For advice about retrofitting, contact your nearest Woltornus A/S sales consultant or distributor. Contact information: see section 13.

Tetra push handles (image 57)

Tetra push handles can be chosen when ordering the wheelchair or purchased subsequently for retrofitting. For advice about retrofitting, contact your nearest Woltornus A/S sales consultant or distributor. Contact information: See section 13.

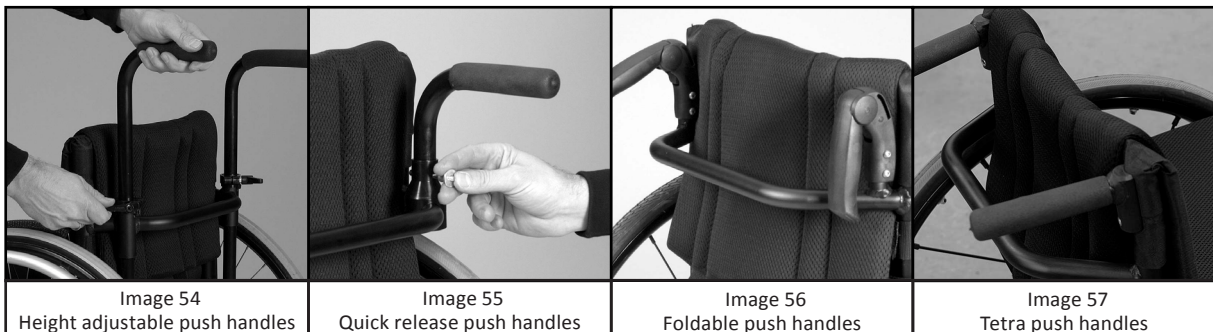

7.2 Wing Back multi-adjustable back system

The Wing Back system, developed by Woltornus A/S, is a combined ergonomic support system for trunk and back that can be optimised. It can be used to meet a wide range of individual seating position requirements (image 58)

The Wing Back system is exceptional because the upper part of the back can be adjusted for depth, width and height and also function as a side/body support. Independently of one another, the left and right sides can be steplessly adjusted. Asymmetric adjustment is therefore possible.

Adjusting the Wing Back system

- Use a 3 mm Allen key to loosen the clamp until the Wing Back can be moved freely (image 59).
- Adjust the Wing Back height and angle to meet the user's requirements.
- Tighten the clamp.
- Adjust the Velcro straps according to the procedure for a standard back (see section 6.4).

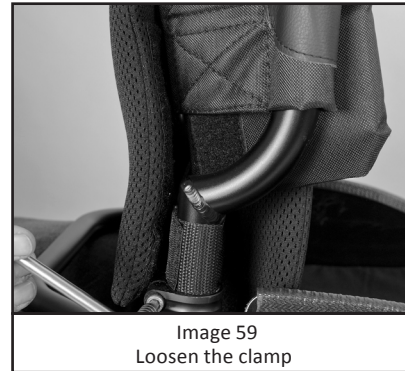

7.3 Wheel locks

The Active wheelchair is supplied with push wheel locks as standard. A range of different wheel locks is available. These can be chosen when ordering the wheelchair or purchased subsequently, for retrofitting.

The full range of wheel locks can be seen at the Wolturnus A/S website www.wolturnus.dk/en/products/.

7.4 Stick-holder

Mobility aids such as walking sticks can be transported in a stick-holder. A stick-holder can be selected when ordering or can be retrofitted (image 60). The stick-holder is mounted on the back axle. It is therefore simple to retrofit.

7.5 Tipping pedal

A tipping pedal makes it easier for helpers to tilt the chair over obstacles such as kerbs and doorsteps (image 61). The tipping pedal is mounted in the same way as a stick-holder.

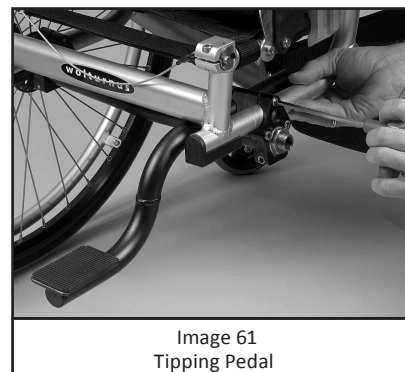

7.6 Upgrading rear wheels, push rims and tyres

The rear wheels and rim can be upgraded to stronger, technically more advanced models; e.g. a Spinergy rear wheel and titanium push rim or Schwalbe Marathon or MTB puncture-proof tyres.

The full range of rear wheels, push rims and tyres can be seen at the Wolturnus A/S website www.wolturnus.dk/en/products/.

7.7 Upgrading casters

Aluminium casters are available. Depending on the wheelchair's current wheel type, it may be necessary to replace both the caster and front fork. The full range of casters can be seen at the Wolturnus A/S website www.wolturnus.dk/en/products/.

7.8 Quick-release axle with tetra-grip for rear wheels

The Quick-release mechanism with tetra-grip makes it easier for, for example, tetraplegics to release the Quick-release and remove the rear wheels. Further information is available at the Wolturnus A/S website www.wolturnus.dk/en/products/.

7.9 Quick-release axle for casters

If quick caster changes are required, a Quick-release axle can be mounted in the front fork. Further information is available at the Wolturnus A/S website www.wolturnus.dk/en/products/.

7.10 Sideguards

The Active wheelchair is supplied with Dibond sideguards as standard. A range of other sideguards made of different materials, with and without mudguard, is available. The full range of sideguards can be seen at the Wolturnus A/S website www.wolturnus.dk/en/products/

7.11 Thermal bridge insulation for sideguards

To insulate in order to prevent thermal bridges, sideguards can be covered with neoprene. Aluminium sideguards are particularly well-suited for this treatment as aluminium conducts heat. Neoprene can either be glued on or secured with Velcro. Templates for custom-made sideguards are retained at Wolturnus A/S so that the right neoprene cover can be recreated in the future.

7.12 Expansion kit and brackets for fixed sideguards (image 62)

An expansion kit can be used to change the distance between sideguards and therefore broaden the seat width. It can, for instance, be used to advantage in colder months when bulky clothing is worn.

7.13 Bracket for locking folded back

The standard option is a folding back that can only be locked in an upright position, not in a folded position. An optional extra bracket allows you to lock the back in a folded position. This makes transport and handling easier because the wheelchair can then be lifted by the back column (image 63).

7.14 Frame protectors

Frame protectors are available to protect the front part of the frame from impact and scratches (image 64). Frame protectors are folded tightly on to the frame and secured with in-built Velcro straps.



7.15 Spoke protectors

Spoke protectors prevent fingers from getting caught in the spokes during propulsion. A wide range of spoke protectors is available with a choice of neutral or patterned designs.

7.16 Calf-support straps for footrests

Calf-support straps prevent the feet from sliding off the footrest (image 65). The straps can be adjusted to ensure that the user's feet are correctly placed on the footrest. To adjust depth, loosen or tighten the Velcro on the calf-support strap. (This feature is not possible with the Dalton wheelchair)

7.17 Bags

Catheter bags are available in three leather models:

- Catheter bag for mounting on the back
- Small catheter bag for mounting under the seat
- Large catheter bag for mounting under the seat (image 66)

7.18 Seat cushions

Seat cushions are available in various models and in the required size and thickness. The seat cushion range is available at the Wolturnus A/S website www.wolturnus.dk/en/products/.

7.19 Straps, belts and restraints

A range of different straps and belts are available for different purposes. The hip strap is one of the most commonly used. It is recommended for use during transport in order to prevent the user falling out of the wheelchair (image 67).

WARNING!

A loose hip strap can cause the user to slide down and risk choking. The user must sit all the way back in the seat and the pelvis must be as straight as possible. The hip strap is tightened over the lower section of the pelvis. The hip strap should be tight enough to just allow a flat hand between the body and the hip strap.



Image 65
Calf-support strap

Image 66
Bags

Image 67
Straps and belts

8 Cleaning and maintenance

8.1 Maintenance

Each time the wheelchair is used, operational parts, and particularly wheel locks, should be checked to ensure they are in proper working order. After being loosened 2-3 times when making adjustments or changing parts, self-locking nuts should be replaced.

The following table gives an overview of how to maintain the chair and how often.

Component	Function and inspection	Daily	Month	1/4 Year
Tyres	Tyres visibly pumped	X		
	Tyres are not damaged	X		
	Test/adjust tyre pressure (see side of tyre)		X	
	Check thread depth (min. 1 mm)		X	
Rear wheel	Directional stability during use	X		
	Wheels rotate freely without misalignment		X	
	Nuts on rear wheel mounting bracket are tight		X	
Caster	No front fork obstruction		X	
	Wheels rotate freely without misalignment		X	
	Axle bolts correctly tightened		X	
	Cap bolts correctly tightened		X	
Folding back	Fasteners are not obstructed		X	
	Nuts and bolts are tightened		X	
	The pawl locks correctly in the bracket		X	
Footrest	Any locking mechanisms are in working order		X	
	No obstructions or damage		X	
Upholstery	No damage or wear to upholstery		X	
	Securing straps function		X	
	Seat and back upholstery correctly positioned		X	
Wheel locks	Wheel locks in working order	X		
	Correct wheel lock pressure on tyre (5 mm)		X	
Sideguards and armrests	Arm rest cushion is not loose	X		
	Side panel and armrest mounting nuts and bolts are tightened.		X	
Screws	All nuts and screws are tightened			X

In the event of faults or missing parts, contact the supplier or Wolturnus A/S. Contact information: see section 13. Wolturnus A/S recommends that the the wheelchair is serviced at least once a year by the supplier or Wolturnus A/S.

INFORMATION

After storage of the wheelchair for a longer period of time, perform maintenance accordingly.

8.2 Cleaning and disinfection

The wheelchair should be cleaned regularly according to how often it is used and how dirty it is.

Clean the frame, plastic parts and wheels with a mild cleaning agent. After cleaning, dry all parts with a dry cloth.

Clean cushions and upholstery with warm water and washing-up liquid. Remove stains with a sponge or soft brush. Rinse afterwards with clean water and allow the parts to dry before mounting and using.

To disinfect, use water-based agents and follow the manufacturer’s instructions.

NOTICE

The wheelchair must not be used in salt water. Avoid getting salt, sand and other dirt that can cause damage in the wheel bearings, caster mounting bracket or rear wheels. If this happens, the bearings should be replaced.

NOTICE

Do not wet-wash. Do not use high-pressure equipment or a water jet. The wheelchair components must not be put in a washing machine.

NOTICE

Do not use corrosive cleaning agents, solvents or hard brushes.

NOTICE

Clean the seat and back upholstery, cushions, handles and armrest before disinfecting.

8.3 Changing a tyre

If a tyre is punctured, the user or a helper may be able to change it themselves. It requires some hand strength, practical ability and suitable tools. It is advisable to always have a puncture repair kit and an air pump for emergencies (excluding situations with puncture-proof tyres). Suitable air pumps, puncture repair kits or puncture sprays that fill the tyre with expanding foam can be purchased at bicycle shops.

Removing tyres and tubes

- Gently pull the tyre edge over the rim edge with a lever (or two, if it is sitting very tightly). Take care not to damage the rim or tube (image 68).
- Screw off the valve nut and pull the valve out from the rim and rim strap.
- Pull the tube out from between the tyre and rim (image 69).

Repair and check-ups

- Repair the tube according to the instructions on the repair kit or replace it with a new tube.
- Before remounting the tyre and tube, make sure no foreign objects that may have caused the puncture are caught in the rim or tyre.
- Ensure that the tyre band is intact. It protects the tube from spoke damage.
- Push the tube into place between the tyre and rim.

Mounting tyres

- Gently pull the clear tyre edge over the edge of the rim. Start with the valve.
- Check that there are no twists at all in the tube, otherwise air can get out.
- Work the whole way around until the last section of the tyre edge is taut and can be edged into place with one or two levers.

Pumping

- Check on both sides that the tube is not caught between the tyre edge and rim.
- Push the valve lightly in and pull out again to make sure that it is not caught on the tyre edge.
- Fill the tyre with air to the point that it can still be pressed in with a thumb. If the control line on both sides of the tyre indicates the same distance to the rim edge, the tyre is centred. If the tyre is not centred, let some air out and adjust the tyre until it is centred. Now pump the tyre up to the maximum working pressure (see side of tyre) or at least 3.5 bars (350 kPa) and screw the dust cap on tightly.

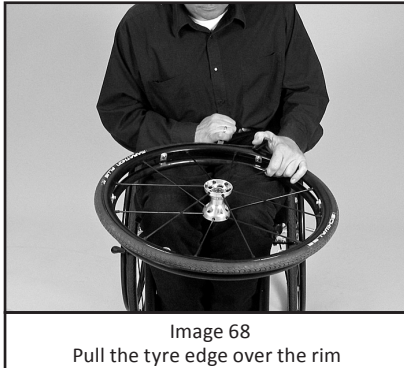

CAUTION!

Ensure the tyres have the correct pressure before using the chair again. The maximum air pressure limit is marked on the side of the tyre. It must always be minimum 3.5 bars (350 kPa) on rear wheels. Like push wheel locks, knee-lever wheel locks are only effective when air pressure is sufficiently high and when they are correctly positioned. (When locked, the brake pad should push the tyre in 5mm (allowing for technical alterations)).

INFORMATION

NB: Pneumatic tyres are good for handling and manoeuvring. Solid tyres are good for work situations in which there might be a risk of debris or other items that could puncture a pneumatic tyre.

9 Troubleshooting

During routine maintenance, it may be necessary to make adjustments or repair faults. In most cases, the solution to the problem can be found on the following list:

Problem	Solution	Reference
Caster makes noise or is resistant	<ul style="list-style-type: none"> • Check if there is dirt between the fork and caster or dirt in the fork ball-bearings. • Clean off the dirt and tighten the screws. If they do not roll freely, change the ball-bearings. 	Section 6.15
Front fork shakes	<ul style="list-style-type: none"> • Loosen and remove the bearing housing cap and tighten the nut to a degree where the front fork with wheel can still easily rotate. • Make sure the caster is vertical. 	
Rear wheel makes a loud clicking noise	<ul style="list-style-type: none"> • Check and tighten the spokes and the push rim mounting screws. • Check that nothing is pushing against the rear wheel or spokes. 	
Rear wheel resistance	<ul style="list-style-type: none"> • Check if the rear wheel is misaligned. • Check if, for example, the side panel or another part is pushing against the rear wheel. • Check if the rear wheel bearings are worn and need to be replaced. 	
Loud clicking noise	<ul style="list-style-type: none"> • Check and tighten the screws in the rear wheel and caster mounting brackets 	Section 6.8
Footrest is lopsided	<ul style="list-style-type: none"> • Check that the foot plate is horizontal and adjust the footrest height. 	Section 6.9-6.10
Wheel locks do not work properly	<ul style="list-style-type: none"> • Check that both wheel locks are correctly positioned. • Inspect the rear wheel tyres for wear and tear and for incorrect tyre pressure. 	Section 6.12 Section 8.3

If the problem cannot be solved with the aid of the troubleshooting section, contact the supplier or Wolturnus A/S. Contact information: section 13.

10 Technical data

Weights and Measures	SW 360	SW 380	SW 400	SW 420	SW 450	SW 480
Seat Width (SW) (mm)	360	380	400	420	450	480
Total Width (TW) (mm)	530	550	570	590	620	650
Seat Width - adjustability	No	No	No	No	No	No
Seat Depth (SD) (mm)	250-500	250-500	250-500	250-500	250-500	250-500
Seat Depth - adjustability	Yes	Yes	Yes	Yes	Yes	Yes
Total Length (TL) (mm)	830	830	830	830	830	830
Total Length Folded (mm)	830	830	830	830	830	830
Total Height	550-1020	550-1020	550-1020	550-1020	550-1020	550-1020
Folded Height (mm) ⁽¹⁾	550-585	550-585	550-585	550-585	550-585	550-585
Seat Height, front and rear (SH-f/r) (mm)	300-520	300-520	300-520	300-520	300-520	300-520
Seat Height - adjustability	Yes	Yes	Yes	Yes	Yes	Yes
Footrest to Seat (VSL)	350-480	350-480	350-480	350-480	350-480	350-480
Leg to Seat surface angle	75°-100°	75°-100°	75°-100°	75°-100°	75°-100°	75°-100°
Back Height (BH) (mm)	250-500	250-500	250-500	250-500	250-500	250-500
Back Height - adjustability	Yes	Yes	Yes	Yes	Yes	Yes
Backrest Angle - adjustability ⁽¹⁾	No	No	No	No	No	No
Locking of Back when Folded	No	No	No	No	No	No
Front Frame Model	U/V/UV	U/V/UV	U/V/UV	U/V/UV	U/V/UV	U/V/UV
Turning Radius (mm)	600	600	600	600	600	600
Max. Tare-weight with Rear Wheels* (kg)	6.5	6.5	6.5	6.5	6.5	6.5
Max. Tare-weight without Rear Wheels* (kg)	4.5	4.5	4.5	4.5	4.5	4.5
User weight	Max. 120-250 kg	Max. 120-250 kg	Max. 120-250 kg	Max. 120-250 kg	Max. 120-250 kg	Max. 120-250 kg
Rear Wheel Camber	1° - 3° - 5°	1° - 3° - 5°	1° - 3° - 5°	1° - 3° - 5°	1° - 3° - 5°	1° - 3° - 5°
Back to Rear Axle (RA) (mm)	80	80	80	80	80	80
Rear Axle - adjustability ⁽²⁾	No	No	No	No	No	No

(1) Only folding back (2) Only adjustable rear axle

NB: A user weight of max. 120 kg. will not usually be relevant if the seat width is narrow.

NB: Data may change depending on model and specific requirements. Some of the data may be specified with the personal orderform. The weight of individual parts will vary based on configuration. Contact Wolturnus A/S for more information about these.

Weights and Measures	SW 360	SW 380	SW 400	SW 420	SW 450	SW 480
(Optional) Securing in Vehicles	Yes	Yes	Yes	Yes	Yes	Yes
(Optional) Arm Rest	Yes	Yes	Yes	Yes	Yes	Yes
Height Seat tube to Armrest (AS) (mm)	200-300	200-300	200-300	200-300	200-300	200-300
Backrest to front armrest	280-290	280-290	280-290	280-290	280-290	280-290
(Optional) Pushrim Ø	490-670	490-670	490-670	490-670	490-670	490-670
(Optional) Anti-tip Device	Yes	Yes	Yes	Yes	Yes	Yes

Stability Direction	Scenario	Tipping Angle
Downhill	Front Wheels Unlocked	15°
	Driving Wheels Locked	7°
Uphill	Driving Wheels Unlocked	11°
	With Anti-tip Devices Engaged	15°
Sideways	Left	15°
	Right	15°

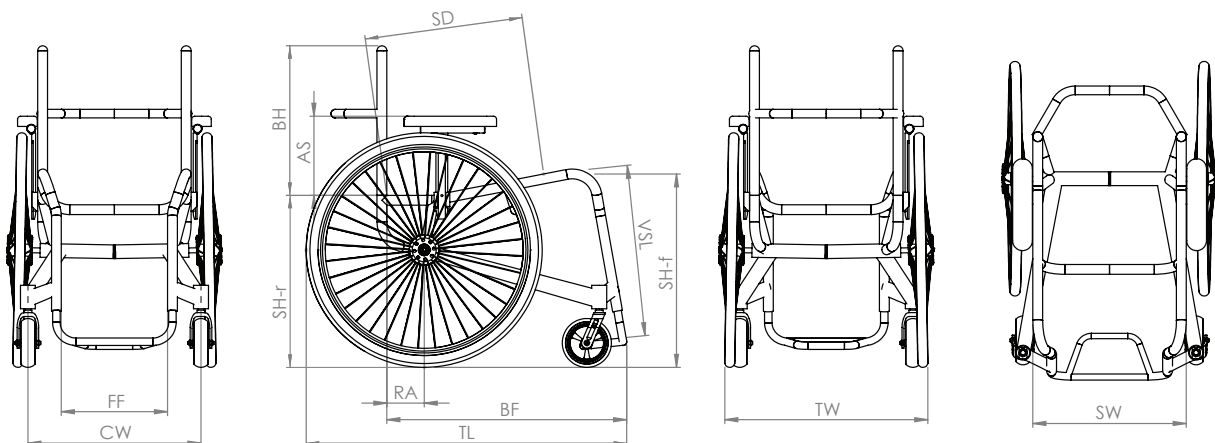

SW	Seat Width	RA	Front of Back to Center Rear Axel
SD	Seat Depth	BF	Front of Back to front Footrest
SH-r	Seat Height rear	FF	Inner Front Frame
SH-f	Seat Height front	CW	Center Caster bearings
BH	Back Height	TW	Total Width
AS	Height Armrest to Seat Tube	TL	Total Length
VSL	Seat Surface to Rear Footrest		

11 Instructions for reuse

11.1 Instructions for reuse

The Active wheelchair is suitable for reuse by a subsequent new owner. As the wheelchair is individual and custom-made, it is essential that the chair measurements and equipment are tailored to suit the new user. As with machinery and vehicles, there will be wear and tear. It is therefore important to ensure that the chair's functions and features have not been altered to a degree that could create a safety risk for the new user or any third parties during the lifetime of the chair.

Based on market studies and on its knowledge of contemporary technology, Wolturnus A/S has calculated that the Active wheelchair, when used, serviced and maintained in accordance with the original instructions, has a five-year lifetime (excluding time kept in storage by an authorised dealership or the user). Note that with careful care and proper use, the Active wheelchair can be used for a longer period than the defined lifetime.

Prior to reuse, the wheelchair must be carefully cleaned and disinfected. The product must then be inspected by an authorised specialist to assess its condition, wear and tear and damage. All worn or damaged parts and components that do not suit or are not designed for the new user must be replaced. This user manual includes a service plan (see maintenance chart section 8) and detailed information about the wheelchair.

11.2 Disposal

The Active wheelchair is delivered in a brown cardboard box that can be delivered to recycling centres or cardboard collection points. The protective bubble wrap on the frame must be disposed of as combustible waste. The aluminium frame must be disposed of as metal. The upholstery and sideguards must be disposed of as combustible waste.

12 Environment

Wolturnus A/S strives to respect the environment to the greatest degree possible. An assessment has been done to determine the wheelchair's effect on the environment during its life cycle. During development, materials and forms are chosen that minimise waste of energy and material during production.

Wolturnus A/S has a unique approach to individual user measurement and to subsequent tailoring of the chair to meet the user's needs. Combined with the wheelchair's high mechanical quality, this ensures that the user can use the wheelchair for many years. The wheelchair lifetime is calculated to be approximately five years if it is maintained according to the instructions in this user manual. The long lifetime limits its effect on the environment.

Furthermore, meticulous quality control throughout the production process ensures that faults are rare, which limits the need to use superfluous resources on repairs or replacement products.

Generally, all work at Wolturnus A/S is carried out with respect for the environment. Aluminium residue after the production process is collected in containers and delivered for recycling. During the mounting process, use of hazardous agents is kept to a minimum and the work processes meet occupational safety requirements (APV). Use of material is continually optimized to ensure minimum waste.

13 Manufacturer and service locations

Service locations

In Denmark, authorised sales consultants throughout the country are in direct contact with Wolturnus A/S about spare parts, service and repairs.

Authorised distributors for Wolturnus A/S abroad:

- Finland: Respecta
- The Netherlands: Double Performance
- New Zealand: Euromedical
- Germany, Austria and the Czech Republic: Otto Bock

After-sales spare parts are available for all Wolturnus wheelchairs.

Manufacturer

Wolturnus A/S

Halkærvej 24B

Bislev

DK-9240 Nibe

Danmark

Tel: +45 9671 7170

Fax: +45 9671 7180

Email: info@wolturnus.dk

Webide: <http://www.wolturnus.dk>

Webshop for purchasing equipment and spare parts: <http://www.wolturnus.dk/en/products/>

Wolturnus A/S active wheelchairs are CE and TÜV approved in accordance with the requirements of Directive 93/42/EEC for medical devices (Class 1) and DS/EN 12183.

Kundeservice/Customer Service

Wolturnus A/S
Skalhuse 31
9240 Nibe

Telefon: +45 96 71 71 70
www.wolturnus.dk
Mail: info@wolturnus.dk

Produktion/Production

Wolturnus A/S
Halkjærvej 24B
9240 Nibe



WOLTURNUS