

Invacare® FDX®

en Power Wheelchair User Manual



This manual **MUST** be given to the user of the product.
BEFORE using this product, this manual **MUST** be read and saved for
future reference.



Yes, you can.®

© 2019 Invacare Corporation

All rights reserved. Reproduction, duplication or modification in whole or in part is prohibited without prior written permission from Invacare. Trademarks are identified by ™ and ®. All trademarks are owned by or licensed to Invacare Corporation or its subsidiaries unless otherwise noted.

Contents

1 General	7
1.1 Introduction	7
1.2 Symbols in This Manual	7
1.3 Intended Use	8
1.4 Indications	8
1.5 Type Classification	8
1.6 Regulations	8
1.7 Usability	8
1.8 Warranty Information	9
1.9 Service Life	9
1.10 Limitation of Liability	9
2 Safety	10
2.1 General Safety Notes	10
2.2 Safety Information With Regard to Care and Maintenance	13
2.3 Safety Information on Electromagnetic Interference	13
2.4 Safety Information on driving and freewheel mode	15
2.5 Safety Information Regarding Changes and Modifications to the Mobility Device	16
2.6 Safety Information on Wheelchairs with a Lifter	18
2.7 Labels on product	19
3 Components	22
3.1 Main parts of the wheelchair	22
3.2 Remotes	22
3.3 The Lifter	22
4 Accessories	24
4.1 Posture Belts	24
4.1.1 Types of posture belts	24
4.1.2 Adjusting Posture Belt Correctly	25
4.2 Using Cane Holder	25
4.3 Using KLICKfix Adapter	25

5 Setup	27
5.1 General setup information	27
5.2 Adjustment Possibility for Remote	28
5.2.1 Adjusting Remote for Length of User's Arm	29
5.2.2 Adjusting Remote Height (only for Swing-Away Remote Supports)	29
5.2.3 Adjusting Remote Offset	29
5.2.4 Swivelling Remote to Side	30
5.3 Adjustment options for standard armrests	30
5.3.1 Changing the arm support position	30
5.3.2 Setting height of armrests	30
5.3.3 Adjusting width of armrests	31
5.4 Adjustment options for parallel sliding armrests	31
5.4.1 Setting the height of the parallel sliding armrests	31
5.4.2 Adjusting angle of armpad on parallel sliding armrests	32
5.4.3 Adjusting the width of the parallel sliding armrests	32
5.4.4 Adjusting the mobility of the parallel sliding armrests	33
5.4.5 Adjusting the arm support positions for the parallel sliding armrests	34
5.5 Adjusting Manual Chin Control	35
5.5.1 Adjusting Extremity Control Joystick	35
5.5.2 Adjusting Egg Switch	36
5.5.3 Adjusting Swing-Away Mechanism	36
5.6 Adjusting Powered Chin Control	37
5.6.1 Adjusting Extremity Control Joystick	37
5.6.2 Adjusting Joysticks and Switches on Linkage	38
5.6.3 Adjusting Height of Linkage Switch	39
5.7 Adjustment Options for Modulite Seat Unit	40
5.7.1 Adjusting Armrest Height	40
5.7.2 Adjusting Armrest Width	40
5.7.3 Adjusting Armrest Depth	41
5.7.4 Adjusting Seat Width	41
5.7.5 Adjusting the seat depth	42

5.8	Adjusting the seat angle	42	5.16	Center-mounted legrests — manually adjustable	58
5.8.1	Manual	43	5.16.1	Removing the legrest	58
5.9	Adjusting Backrest	43	5.16.2	Setting the angle of the leg rest	59
5.9.1	Adjusting the backrest (standard seat) — manually with splint-pins	43	5.16.3	Setting Length of Legrest	59
5.9.2	Adjusting the back seat angle on the Easy-Adapt seating system	44	5.16.4	Setting Angle of Foot Plate	60
5.9.3	Adjusting Backrest Height	44	5.16.5	Setting Angle and Height of Calf Pad	60
5.9.4	Adjusting Backrest Width	44	5.17	LNx legrest	60
5.9.5	Adjusting Backrest Angle	45	5.17.1	Setting the length of the legrest	60
5.9.6	Adjusting the adaptable backrest padding	46	5.17.2	Setting Angle of Foot Plate	61
5.10	Adjusting Rea Headrest	48	5.17.3	Setting Height and Width of Calf Pad	61
5.10.1	Adjusting Position of Rea Headrest or Neckrest	48	5.18	Vari-F footrest	62
5.10.2	Adjusting Height of Rea Headrest or Neckrest	48	5.18.1	Swivelling the footrest/legrest outward and/or removing	62
5.10.3	Adjusting Cheek Supports	49	5.18.2	Setting the angle	62
5.11	Adjusting Elan Headrest	49	5.18.3	Setting the end stop of the footrest	63
5.11.1	Adjusting Elan Headrest Hardware	50	5.18.4	Adjusting the length of the footrest	65
5.12	Adjusting the trunk support (Easy-Adapt seating system)	51	5.19	Vari-A legrests	65
5.12.1	Adjusting the width	52	5.19.1	Swivelling the footrest/legrest outward and/or removing	65
5.12.2	Adjusting the height	52	5.19.2	Setting the angle	66
5.12.3	Adjusting the depth	52	5.19.3	Setting the end stop of the legrest	67
5.13	Adjusting/Removing Tray	53	5.19.4	Adjusting the length of the legrest	69
5.13.1	Adjusting Tray Laterally	53	5.19.5	Adjusting the depth of the calf pad	69
5.13.2	Adjusting Depth of Tray/Removing Tray	53	5.19.6	Adjusting the height of the calf pad	70
5.13.3	Swinging Tray Away to Side	53	5.19.7	Unlocking and swivelling the calf pad backward when alighting	70
5.14	Seat support	54	5.19.8	Adjusting the angle-adjustable foot plate	71
5.14.1	Adjusting seat width	54	5.19.9	Adjusting the angle- and depth-adjustable foot plate	71
5.14.2	Adjusting the seat depth	55	5.20	ADM legrests	72
5.14.3	Adjusting the seat depth without replacing the seat support plate	56	5.20.1	Swivelling the legrest outward and/or removing	72
5.14.4	Adjusting the seat depth with replacing the seat support plate	57	5.20.2	Setting the angle	72
5.15	Backrest unit with ergonomic length compensation (Easy-Adapt)	58	5.20.3	Adjusting the length of the legrest	73
5.15.1	Adjusting the width	58	5.20.4	Adjusting the depth of the calf pad	73
			5.20.5	Adjusting the height of the calf pad	74

5.20.6	Unlocking and swivelling the calf pad backward when alighting	74	7.2.1	General Information on Charging	86
5.20.7	Adjusting the angle-adjustable foot plate	75	7.2.2	General Instructions on Charging	86
5.20.8	Adjusting the angle- and depth-adjustable foot plate	75	7.2.3	Charging Batteries	87
5.21	Powered elevating legrests (ADE legrests).	76	7.2.4	Disconnecting Mobility Device After Charging	88
5.21.1	Swivelling the legrest outward and/or removing	76	7.2.5	Storage and Maintenance.	88
5.21.2	Setting the angle	76	7.2.6	Instructions on Using Batteries	88
5.21.3	Adjusting the length of the legrest	76	7.2.7	Transporting Batteries	89
5.21.4	Adjusting the depth of the calf pad	77	7.2.8	General Instructions on Handling Batteries	89
5.21.5	Adjusting the height of the calf pad	77	7.2.9	Handling Damaged Batteries Correctly	89
5.21.6	Unlocking and swivelling the calf pad backward when alighting	77	7.2.10	Use the correct batteries	90
5.21.7	Adjusting the angle-adjustable foot plate	78	8 Transport	91	
5.21.8	Adjusting the angle- and depth-adjustable foot plate	78	8.1	Transport — General information.	91
5.22	Adjusting the width of side-mounted legrests.	79	8.2	Transferring Mobility Device to Vehicle	91
6 Usage	80		8.3	Use of Mobility Device as Seat in Vehicle.	92
6.1	Before Driving for First Time	80	8.3.1	How the mobility device is anchored in a vehicle for use as a vehicle seat.	94
6.2	Getting in and out of Mobility Device	80	8.3.2	How the user is secured within the mobility device	95
6.2.1	Removing armrests to get in	80	8.4	Transporting the mobility device without occupant	97
6.2.2	Disconnecting Remote	80	8.4.1	Removing the front shroud.	97
6.2.3	Information About Getting in and out.	81	8.4.2	Removing the rear shroud	98
6.3	Taking Obstacles	81	8.4.3	Removing/Installing the batteries	98
6.3.1	Maximum Obstacle Height	81	8.5	Dahl Docking System.	99
6.3.2	Safety Information When Taking Obstacles	82	9 Maintenance	103	
6.3.3	Correct Way to Take Obstacles	82	9.1	Maintenance Introduction	103
6.4	Driving up and down Gradients	83	9.2	Cleaning Mobility Device	103
6.5	Parking and Stationary	84	9.3	Inspection Checks	103
6.6	Use on Public Roads	84	9.3.1	Before Each Use of Mobility Device	103
6.7	Pushing the mobility device in freewheel mode	84	9.3.2	Weekly	104
6.7.1	Disengaging motors (conventional motors)	84	9.3.3	Monthly.	104
7 Controls System	86		9.4	Wheels and Tyres	105
7.1	Controls Protection System	86	9.5	Short-Term Storage	106
7.2	Batteries	86	9.6	Long-Term Storage	106
			10 After Use	107	
			10.1	Reconditioning	107

10.2 Disposal	107
11 Technical Data	108
11.1 Technical specifications	108
12 Service	115
12.1 Inspections Performed.	115

1 General

1.1 Introduction

This user manual contains important information about the handling of the product. To ensure safety when using the product, read the user manual carefully and follow the safety instructions.

Note that there may be sections in this document, which are not relevant to your product, since this document applies to all available models (on the date of printing). If not otherwise stated, each section in this document refers to all models of the product.

The models and configurations available in your country can be found in the country-specific price lists.

Invacare reserves the right to alter product specifications without further notice.

Before reading this document, make sure you have the latest version. You find the latest version as a PDF on the Invacare website.

If you find that the font size in the printed document is difficult to read, you can download the PDF version from the website. The PDF can then be scaled on screen to a font size that is more comfortable for you.

For more information about the product, for example product safety notices and product recalls, contact your Invacare representative. See addresses at the end of this document.

In case of a serious incident with the product, you should inform the manufacturer and the competent authority in your country.

1.2 Symbols in This Manual

In this manual, hazard statements are indicated by symbols. The symbols are accompanied by a signal word that indicates the severity of the risk.



WARNING

Indicates a hazardous situation that could result in serious injury or death if it is not avoided.



CAUTION

Indicates a hazardous situation that could result in minor or slight injury if it is not avoided.



IMPORTANT

Indicates a hazardous situation that could result in damage to property if it is not avoided.



Gives useful tips, recommendations and information for efficient, trouble-free use.



This product complies with Directive 93/42/EEC concerning medical devices. The launch date of this product is stated in the CE declaration of conformity.



This symbol identifies a list of various tools, components and items which you will need in order to carry out certain work.

1.3 Intended Use

This mobility device was designed for persons whose ability to walk is impaired, but who are still in terms of their eyesight and physically and mentally able to operate an electric mobility device.

1.4 Indications

The use of this power wheelchair is recommended for the following indications:

- The inability or a greatly restricted ability to walk within the scope of the basic requirement to be able to move within one's own four walls.
- The need to leave the dwelling place in order to get some fresh air during a short walk or to reach those places generally to be found at close distance to the dwelling and where everyday business is carried out.

Provision of power wheelchairs for interior and exterior areas is advisable if the use of hand-operated wheelchairs is no longer possible on account of the disability, yet proper operation of an electromotive drive unit is still practicable.

Contraindications

There are no contraindications known.

1.5 Type Classification

This vehicle has been classified according to EN 12184 as a **class B mobility product** (for indoor and outdoor areas). It is therefore compact and agile enough for indoor areas, but also able to overcome many obstacles in outdoor areas.

1.6 Regulations

The vehicle was successfully tested according to German and international standards as to its safety. It satisfies the requirements according to RoHS 2011/65/EU, REACH 1907/2006/EC and DIN EN 12184 including EN 1021-2 and ISO 7176–14. It was also tested successfully according to EN 60529 IPX4 as to its resistance to spray water, and is therefore well suited for weather conditions such as typical European weather conditions. When equipped with an appropriate lighting system, the vehicle is suitable for use on public roads.

1.7 Usability

Only use a mobility device when it is in perfect working order. Otherwise, you might put yourself and others at risk.

The following list does not claim to be exhaustive. It is only intended to show some of the situations that could affect the usability of your mobility device.

In certain situations, you should immediately stop using your mobility device. Other situations allow you to use the mobility device to get to your provider.

You should immediately stop using your mobility device if its usability is restricted due to:

- Unexpected driving behaviour
- brake failure

You should immediately contact an authorised Invacare provider if the usability of your mobility device is restricted due to:

- the lighting system (if fitted) failing or being defective
- reflectors falling off

- worn thread or insufficient tire pressure
- damage to the armrests (e.g. torn armrest padding)
- damage to the legrest hangers (e.g. missing or torn heel straps)
- damage to the postural belt
- damage to the joystick (joystick cannot be moved into the neutral position)
- cables that are damaged, kinked, pinched or have come loose from the fixation
- the mobility device drifting when braking
- the mobility device pulling to one side when moving
- unusual sounds developing or occurring

Or if you have the feeling that something is wrong with your mobility device.

1.8 Warranty Information

We provide a manufacturer's warranty for the product in accordance with our General Terms and Conditions of Business in the respective countries.

Warranty claims can only be made through the provider from whom the product was obtained.

1.9 Service Life

We estimate a service life of five years for this product, provided it is used in strict accordance with the intended use as set out in this document and all maintenance and service requirements are met. The estimated service life can be exceeded if the product is carefully used and properly maintained, and provided technical and scientific advances do not result in technical limitations. The service life can also be considerably reduced by extreme or incorrect usage.

The fact that we estimate a service life for this product does not constitute an additional warranty.

1.10 Limitation of Liability

Invacare accepts no liability for damage arising from:

- Non-compliance with the user manual
- Incorrect use
- Natural wear and tear
- Incorrect assembly or set-up by the purchaser or a third party
- Technical modifications
- Unauthorised modifications and/or use of unsuitable spare parts

2 Safety

2.1 General Safety Notes

**DANGER!****Risk of Death, Serious Injury, or Damage**

Lighted cigarettes dropped onto an upholstered seating system can cause a fire resulting in death, serious injury, or damage. Mobility device occupants are at particular risk of death or serious injury from these fires and resulting fumes because they may not have the ability to move away from the mobility device.

- DO NOT smoke while using this mobility device.

**WARNING!****Risk of Injury, Damage or Death**

Improper monitoring or maintenance may cause injury, damage or death due to ingestion or choking on parts or materials.

- Closely supervise children, pets, or people with physical/mental disabilities.

**WARNING!****Risk of Death, Serious Injury or Damage**

Improper routing of cables may cause a tripping entanglement or strangulation hazard that may result in death, serious injury or damage.

- Ensure all cables are routed and secured properly.
- Ensure there are no loops of excess cable extending away from the wheelchair.

**WARNING!****Risk of injury if mobility device is used in any other way than the purpose described in this manual**

- Only ever use the mobility device in accordance with the instructions in this user manual.
- Pay strict attention to the safety information.

**WARNING!****Risk of injury if the mobility device is driven when ability to operate a vehicle is impaired by medication or alcohol**

- Never drive the mobility device under the influence of medication or alcohol. If necessary, the mobility device must be operated by an attendant who is physically and mentally able.

**WARNING!****Risk of damage or injury if mobility device is accidentally set into motion**

- Switch the mobility device off before you get in, get out or handle unwieldy objects.
- When the drive is disengaged, the brake inside the drive is deactivated. For this reason, pushing the mobility device by an attendant is only recommended on flat surfaces, never on gradients. Never leave your mobility device on a gradient with its motors disengaged. Always re-engage the motors immediately after pushing the mobility device (refer to Pushing the mobility device in freewheel mode).

**WARNING!****Risk of injury if the mobility device is switched off while driving, for example by pressing the On/Off Button or disconnecting a cable, due to it coming to an abrupt, sharp stop**

- If you have to brake in an emergency, simply release the joystick which will bring you to a halt (refer to the remote user manual for more information).

**WARNING!****Risk of injury when transferring mobility device to a vehicle for transport with the occupant seated in it**

- It is always better to transfer the mobility device to a vehicle without the occupant seated in it.
- If the mobility device needs to be loaded up a ramp together with its driver, ensure that the ramp does not exceed the rated slope (refer to *11 Technical Data, page 108*).
- If the mobility device does need to be loaded using a ramp which exceeds the rated slope (refer to *11 Technical Data, page 108*), then you must use a winch. An attendant can safely monitor and assist the loading process.
- As an alternative you can use a platform lift. Ensure that the total weight of the mobility device including the user does not exceed the maximum permissible weight for the platform lift or winch if you are using.



WARNING!

Risk of falling out of the mobility device

- Do not slide forward on the seat, do not lean forward between your knees, do not lean backwards out over the top of the backrest, for example to reach an object.
- If a posture belt is installed, it should be correctly adjusted and used each time you use the mobility device.
- When transferring to a different seat, position the mobility device as close as possible to the new seat.



WARNING!

Risk of Serious Injury or Damage

Storing or using the mobility device near open flame or combustible products can result in serious injury or damage.

- Avoid storing or using the mobility device near open flame or combustible products.



CAUTION!

Risk of injury if maximum permissible load is exceeded

- Do not exceed the maximum permissible load (refer to *11 Technical Data, page 108*).
- The mobility device is only designed for use by a single occupant whose maximum weight does not exceed the maximum permissible load of the device. Never use the mobility device to transport more than one person.



CAUTION!

Risk of injury due to wrong lifting or dropping of heavy components

- When maintaining, servicing or lifting any part of your mobility device, take into account the weight of the individual components especially the batteries. Be sure at all times to adopt the correct lifting posture and ask for assistance if necessary.



CAUTION!

Risk of injury by moving parts

- Make sure that no injury is incurred by moving parts of the mobility device, like wheels or one of the lifter modules (if fitted), especially when children are around.



CAUTION!

Risk of injury from hot surfaces

- Do not leave the mobility device in direct sunlight for prolonged periods. Metal parts and surfaces such as the seat and armrests can become very hot.

**CAUTION!**

Risk of fire or breaking down due to electric devices being connected

- Do not connect any electric devices to your mobility device that are not expressly certified by Invacare for this purpose. Have all electrical installations done by your authorized Invacare provider.

2.2 Safety Information With Regard to Care and Maintenance

**WARNING!**

Risk of death, serious injury, or damage

Incorrect repair and/or servicing of this mobility device performed by users/caregivers or unqualified technicians can result in death, serious injury, or damage.

- DO NOT attempt to carry out maintenance work that is not described in this user manual. Such repair and/or service MUST be performed by a qualified technician. Contact a provider or Invacare technician.

**CAUTION!**

Risk of accident and loss of warranty if maintenance is insufficient

- For reasons of safety and in order to avoid accidents which result from unnoticed wear, it is important that this mobility device undergoes an inspection once every year under normal operating conditions (see inspection plan contained in service instructions).
- Under difficult operating conditions such as daily travel on steep slopes, or in the case of use in medical care cases with frequently changing mobility device users, it would be expedient to carry out intermediate checks on the brakes, accessories and running gear.
- If the mobility device is to be operated on public roads, the vehicle driver is responsible for ensuring that it is in an operationally reliable condition. Inadequate or neglected care and maintenance of the mobility device will result in a limitation of the manufacturer's liability.

2.3 Safety Information on Electromagnetic Interference

This powered mobility device was successfully tested in accordance with International standards as to its compliance with Electromagnetic Interference (EMI) regulations.

However, electromagnetic fields, such as those generated by radio and television transmitters, and cellular phones can influence the functions of powered mobility devices. Also, the electronics used in our mobility devices can generate a low level of electromagnetic interference, which however

will remain within the tolerance permitted by law. For these reasons we ask you to please observe the following precautions:



WARNING!

Risk of malfunction due to electromagnetic interference

- Do not switch on or operate portable transceivers or communication devices (such as radio transceivers or cellular phones) when the mobility device is switched on.
- Avoid getting near strong radio and television transmitters.
- In case the mobility device should be set in motion unintentionally or the brakes are released, switch it off immediately.
- Adding electrical accessories and other components or modifying the mobility device in any way can make it susceptible to electromagnetic interference. Keep in mind that there is no sure way to determine the effect such modifications will have on the overall immunity of the electronic system.
- Report all occurrences of unintentional movement of the mobility device, or release of the electric brakes to the manufacturer.

2.4 Safety information on driving and freewheel mode



WARNING!

Risk of injury if the mobility device tips over

- Inclines and declines can only be travelled up to the maximum safe slope (refer to *11 Technical Data, page 108*).
- Always return the backrest of your seat or the seat tilt to an upright position before ascending slopes. We recommend that you position the seat backrest and the seat tilt (if fitted) slightly to the rear before descending slopes.
- Only ever drive downhill at a maximum of 2/3 of the top speed. Avoid abrupt braking or accelerating on gradients.
- If at all possible, avoid driving on slippery surfaces (such as snow, gravel, ice etc.) where there is a risk of you losing control over the vehicle, especially on a gradient. If driving on such a surface is inevitable, then always drive slowly and with the utmost caution.
- Never attempt to overcome an obstacle when on an uphill or downhill gradient.
- Never attempt to drive up or down a flight of steps with your mobility device.
- When overcoming obstacles, always observe the maximum obstacle height (refer to *11 Technical Data, page 108* and information about overcoming obstacles in *6.3 Taking Obstacles, page 81*).

- Avoid shifting your center of gravity as well as abrupt joystick movements and changes of direction when the mobility device is in motion.



WARNING!

Risk of injury if the mobility device tips over (continued)

- Never use the mobility device to transport more than one person.
- Do not exceed the overall maximum permissible load or the maximum load per axle (refer to *11 Technical Data, page 108*).
- Note that the mobility device will brake or accelerate if you change the driving mode whilst the mobility device is in motion.



WARNING!

Risk of breaking down in adverse weather conditions, i.e. extreme cold, in an isolated area

- If you are a user with severely limited mobility, we advise that in the case of adverse weather conditions DO NOT attempt a journey without an accompanying attendant.



WARNING!

Risk of injury if your foot slides off the footrest and gets caught underneath the mobility device when it is in motion

- Make sure each time before you drive the mobility device that your feet are squarely and

securely in place on the footplates, and that both legrests are properly locked into place.



WARNING!

Risk of injury if you collide with an obstacle when driving through narrow passages such as doorways and entrances

- Drive through narrow passages in the lowest driving mode and with due caution.



WARNING!

If your mobility device has been fitted with elevating legrests, there is a risk of personal injury and damage to the mobility device if you drive the mobility device with the legrests raised

- To avoid unwanted displacement of the mobility device center of gravity to the front (especially when travelling downhill) and in order to avoid damage to the mobility device, elevating legrests must always be lowered during normal travelling.



WARNING!

Risk of tipping

Antitippers (stabilizers) are only effective on firm ground. They sink in on soft ground such as grass, snow or mud if the mobility device rests itself on them. They lose their effect and the mobility device can tip over.

- Only drive with extreme care on soft ground, especially during uphill and downhill journeys. In the process pay increased attention to the tip stability of the mobility device.



Information on models with electric seat angle adjuster

- If your wheelchair is fitted with an electric seat angle adjuster, it is also fitted with a microswitch which automatically reduces the speed as soon as the seat angle exceeds around 15°. To increase speed again, readjust the seat angle to bring it into an almost vertical position.

2.5 Safety Information Regarding Changes and Modifications to the Mobility Device



WARNING!

Risk of serious injury or damage

Use of incorrect or improper replacement (service) parts may cause injury or damage

- Replacement parts **MUST** match original Invacare parts.
- Always provide the wheelchair serial number to assist in ordering the correct replacement parts.

**CAUTION!****Risk of injuries and damage to mobility device due to unapproved components and accessory parts**

Seating systems, additions and accessory parts which have not been approved by Invacare for use with this mobility device can affect the tipping stability and increase tipping hazards.

- Only ever use seating systems, additions and accessory parts which have been approved by Invacare for this mobility device.

Seating systems which are not approved by Invacare for use with this mobility device do not, under certain circumstances, comply with the valid standards and could increase the flammability and the risk of skin irritation.

- Only use seating systems that have been approved by Invacare for this mobility device.

Electrical and electronic components which have not been approved by Invacare for use with this mobility device can cause fire hazards and lead to electromagnetic damage.

- Only ever use electrical and electronic components which have been approved by Invacare for this mobility device.

Batteries which have not been approved by Invacare for use with this mobility device can cause chemical burns.

- Only ever use batteries which have been approved by Invacare for this mobility device.

**CAUTION!****Risk of injuries, and damage to the mobility device, if unapproved backrests are used**

A retrofitted backrest which is not approved by Invacare for use with this mobility device may overload the backrest tube and thus increase the risk of injuries and of damage to the mobility device.

- Please contact your Invacare specialist provider who will perform risk analyses, calculations, stability checks etc. to ensure that the backrest can be used safely.

**CE marking of the mobility device**

- The conformity assessment/CE marking was carried out according to the respective valid regulations and only applies to the complete product.
- The CE marking is invalidated if components or accessories are replaced or added that have not been approved for this product by Invacare.
- In this case, the company that adds or replaces the components or accessories is responsible for the conformity assessment/CE marking or for registering the mobility device as a special design and for the relevant documentation.



Important information about maintenance work tools

- Some maintenance work which is described in this manual and can be carried out by the user without problems require the correct tools for proper work. If you do not have the correct tool available we do not recommend that you try to carry out the relevant work. In this case, we urgently recommend that you contact an authorized specialist workshop.

2.6 Safety Information on Wheelchairs with a Lifter



WARNING!

Risk of injury by moving parts

- Never let objects get caught in the space underneath a raised lifter.
- Make sure that neither you nor anyone else is injured by placing hands, feet or other body extremities under the raised seat.
- Should you not be able to view under the seat, for example, due to limited manoeuvrability, turn the wheelchair once on its own axle before you lower the seat. This will allow you to make sure that nobody is located in the danger zone.



CAUTION!

Risk of injury if the wheelchair tips over

- Never exceed the maximum permissible load (see chapter 11 *Technical Data*, page 108).
- Avoid dangerous driving situations when the lifter is in a raised position, such as trying to overcome obstacles like curbs or driving up or down steep gradients.
- Never lean out of the seat when the lifter is raised.
- Inspect the lifter module at least once a month to make sure the automatic speed reduction function, which reduces the speed of the wheelchair when the lifter is raised, is working properly (see chapter The Lifter). Notify your authorized provider immediately if it is not working properly.



CAUTION!

Risk of malfunction of the lifter module

- Inspect the lifter module at regular intervals to make sure there are no foreign objects or visible damage, and to make sure the electric plugs are firmly inserted into their sockets.



CAUTION!

Damage to wheelchair caused by one-sided loading on lifter pillar

- One-sided loading occurs if the seat is raised and/or tilted. Always return your seat backrest to the upright position and the seat tilting to the horizontal position before ascending slopes. Never subject the lifter pillar to continuous single-sided loading. The raising and tilting function of the seat only provides additional rest positions.









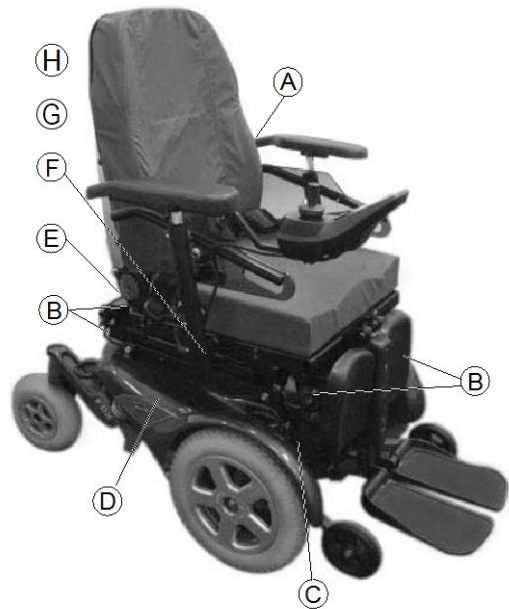

Important information regarding speed reduction with raised lifter

- If the lifter has been raised above a certain point, the drive electronics considerably reduces the speed of the wheelchair. If speed reduction has been activated, drive mode can only be used to carry out minor movements of the wheelchair and not for regular driving. To drive normally, lower the lifter until the speed reduction has been deactivated again. See chapter The Lifter for details.



2.7 Labels on product







A		<p>If the mobility device is fitted with a table, it is imperative that it is removed and safely stored when transporting the mobility device in a vehicle.</p>
B	<p>Identification of the tie-down points at the front and back:</p>	
	 <p>ISO 7176-19</p>	<p>If the symbol appears on a bright yellow sticker, the tie-down point is suitable for fixation of the mobility device in a vehicle for use as a vehicle seat.</p>
C		<p>Identification label sticker under the cover at the front containing the following symbols:</p> <p>For details see below.</p>
D		<p>Identification of the position of the coupling lever for driving and push operation (only the right side is visible in the picture):</p> <p>For details see below.</p>

E	 <p>ISO 7176-19</p>	<p>Warning that the mobility device may not be used as a vehicle seat</p> <p>This mobility device does not satisfy the requirements of ISO 7176-19.</p>
F		<p>Indication of the maximum width to which the armrest can be set</p>
G		<p>Indication of pinch points that could occur on the mobility device</p>
H		<p>Indication not to strain back with more than 6 kg altogether.</p>

Explanation of symbols on labels

	<p>Date of manufacture</p>
	<p>This product complies with Directive 93/42/EEC concerning medical devices. The launch date of this product is stated in the CE declaration of conformity.</p>

	<p>This product has been supplied from an environmentally aware manufacturer. This product may contain substances that could be harmful to the environment if disposed of in places (landfills) that are not appropriate according to legislation.</p> <ul style="list-style-type: none"> • The 'crossed out wheelee bin' symbol is placed on this product to encourage you to recycle wherever possible. • Be environmentally responsible and recycle this product through your recycling facility at its end of life.
	<p>Read the user manual. This symbol appears on different labels and positions.</p>

	<p>This symbol indicates the “Drive” position of the coupling lever. In this position the motor is engaged and the motor brakes are operational. You can drive the mobility device.</p> <ul style="list-style-type: none"> • Note that for driving purposes both motors must always be engaged.
	<p>This symbol indicates the “Push” position of the coupling lever. In this position the motor is disengaged and the motor brakes are not operational. The mobility device can be pushed by an attendant and the wheels turn freely.</p> <ul style="list-style-type: none"> • Note that the remote must be switched off. • Also note the information provided in section 6.7 <i>Pushing the mobility device in freewheel mode</i>, page 84.

3 Components

3.1 Main parts of the wheelchair



- 1 Backrest
- 2 Armrest
- 3 Lever for disengaging a motor (only visible on right-hand side of picture)
- 4 Drive wheel
- 5 Remote
- 6 Legrest

3.2 Remotes

Your mobility device may be fitted with one of several different remotes. For information on the different functions and how to operate a particular remote, refer to its corresponding user manual (enclosed).

3.3 The Lifter

The electric lifter is operated from the remote. Refer to the remote manual for more information.



Information regarding operation of the lifter at temperatures of less than 0 °C

- Invacare mobility devices are fitted with safety mechanisms that prevent capacity overload of the electronic components. At operating temperatures below freezing point this can, in particular, lead to the lifter actuator being shut down after approx. 1 second operating time.
- The lifter can be raised or lowered gradually by repeatedly operating the joystick. In many cases this generates sufficient heat for the actuator to operate as normal.



Speed limiter

The speed limit reacts in different ways, depending on the mobility device's configuration.

- Either the lifter is fitted with sensors which reduce the mobility device's speed as soon as the lifter is raised above a certain point.
- Or if the speed limit is activated, a reduced drive level (forced profile) is set automatically. Refer to the remote manual for more information.
- The speed reduction takes place to guarantee the tipping stability of the mobility device and to avoid personal risk and damage to the mobility device.
- To reapply normal speed, lower the lifter down until the forced profile or the speed reduction switches off.
- If the mobility device is fitted with a chin control, it reacts different to forced profile. Refer to the manual of the chin control for more information.



CAUTION!

Risk of tipping, if the speed limiter sensors fail when the lifter is raised

- If you find that the speed reduction function is not working when the lifter is raised, do not drive with the lifter raised and immediately contact an authorized Invacare provider.

4 Accessories

4.1 Posture Belts

A posture belt is an option which can either be fixed to the mobility device ex-works or can be retrofitted by your specialist provider. If your mobility device is fitted with a posture belt, your specialist provider will have informed you about fitting and usage.

The posture belt is used to help the mobility device user keep an optimum seating position. Correct use of the belt assists the user in sitting securely, comfortably and well-positioned in the mobility device, especially for such users who do not have such a good sense of balance while sitting.



We recommend using the posture belt whenever the mobility device is used.

4.1.1 Types of posture belts

Your mobility device can be fitted with the following posture belt types ex-works. If your mobility device has been fitted with a different belt to those listed below, please ensure that you have received the manufacturer's documentation with regard to correct fitting and use.

Belts with metal buckle, adjustable one side



Belts can only be adjusted on one side which can result in the buckle not sitting centrally.

Belt with plastic buckle, adjustable both sides



Belt can be adjusted on both sides. This means that the buckle can be centrally positioned.

Belt with metal buckle, adjustable both sides



Belt can be adjusted on both sides. This means that the buckle can be centrally positioned.

4.1.2 Adjusting Posture Belt Correctly



The belt should be tight enough to ensure that you are sitting comfortably and that your body is in the correct sitting position.

1. Ensure that you are sitting correctly, which means that you are sitting right at back of seat, your pelvis is positioned erect and as symmetrically as possible, not to front, to side or at one edge of seat.
2. Position posture belt so that your hipbones can be easily felt above belt.
3. Adjust belt length using one of adjustment aids described above. The belt should be adjusted so that you can fit a flat hand between belt and your body.
4. Buckle should be positioned as centrally as possible. In doing so, carry out adjustments on both sides as much as possible.
5. Check your belt every week to ensure that it is still in good working condition, to ensure it has no damage or wear, and that it is fixed properly to mobility device. If belt is only fastened with a bolted connection, ensure that connection has not loosened or come undone. You can find more information about maintenance work on belts in the service manual, which is available from Invacare.

4.2 Using Cane Holder

If your mobility device is fitted with a cane holder, it can be used for the safe transport of a walking cane, underarm or forearm crutches. The cane holder consists of a plastic container (bottom) and a hook-and-loop fastener (top).



CAUTION!

Risk of Injury

A walking cane or crutches that are not secured during transport (on the user's lap, for example) can cause injury to the user or other persons.

- During transport, walking canes or crutches should always be secured using a cane holder.

1. Open upper hook-and-loop fastener.
2. Place lower end of the walking cane or crutches in container at bottom.
3. Walking cane or crutches can be secured at upper end using hook-and-loop fastener.

4.3 Using KLICKfix Adapter

Your mobility device can be fitted with the mini-adapter from the Rixen + Kaul KLICKfix system. To this you can attach various accessories such as the cellphone case supplied by Invacare, which you can use to transport your cellphone, sports glasses etc.



Risk posed by unsecured accessories

Accessories can fall off and get lost if they are not properly secured.

- Check that the accessory is correctly locked in and seated securely every time you use the mobility device.



Risk of breakage due to excessive load

The KLICKfix adapter can break if too great a load is applied.

- The maximum permitted load on the KLICKfix adapter is 1 kg.

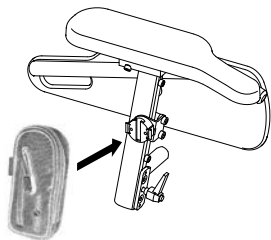

Fig. 4-1

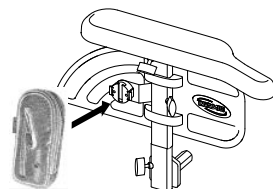

Fig. 4-2

Securing Accessory

1. Push accessory into KLICKfix adapter.
Accessory locks in securely.

Removing Accessory

1. Press red button and remove accessory.

The adapter can turn in 90° steps, allowing you to attach an accessory from any of four different directions. Please refer to the installation instructions which are available from your Invacare provider or directly from Invacare.

More information on the KLICKfix system is available at <http://www.klickfix.com>.

5 Setup

5.1 General setup information



WARNING!

Risk of death, serious injury, or damage

Continued use of the mobility device that is not set to the correct specifications may cause erratic behavior of the mobility device resulting in death, serious injury, or damage.

- Performance adjustments should only be made by professionals of the healthcare field or persons fully conversant with this process and the driver's capabilities.
- After the mobility device has been set-up/adjusted, check to make sure that the mobility device performs to the specifications entered during the set-up procedure. If the mobility device does not perform to specifications, IMMEDIATELY turn the mobility device Off and re-enter set-up specifications. Contact Invacare, if mobility device still does not perform to correct specifications.



WARNING!

Risk of death, serious injury, or damage

Attaching hardware that is loosely secured or missing could cause instability resulting in death, serious personal injury, or property damage.

- After ANY adjustments, repair or service and before use, make sure that all attaching hardware is present and tightened securely.



WARNING!

Risk of injury or damage

Incorrect set up of this mobility device performed by users/caregivers or unqualified technicians can result in injury or damage.

- DO NOT attempt to set up this mobility device. Initial set up of this mobility device MUST be performed by a qualified technician.
- Adjustment by the user is only recommended after they have been given appropriate guidance by the healthcare professional.
- DO NOT attempt to carry out the work if you do not have the listed tools available.



CAUTION!

Damage to mobility device and accident hazard

It is possible that collisions can occur between mobility device components due to various combinations of adjustment options and their individual settings

- The mobility device is fitted with an individual, multiply adjustable seating system including adjustable legrests, armrests, a headrest or other options. These adjustment options are described in the following chapters. They are used to adapt the seat to the physical requirements and the condition of the user. When adapting the seating system and the seat functions to the user, ensure that no mobility device components collide.

! IMPORTANT!

The mobility device is manufactured and configured individually to the specifications of the order. The assessment must be performed by a healthcare professional according to the user's requirements and health conditions.

- Consult a healthcare professional if you intend to adapt the mobility device configuration.
- Any adaptation should be performed by a qualified technician.

 Initial setup should always be done by a healthcare professional. Adjustment by the user is only recommended after they have been given appropriate guidance by the healthcare professional.

 Note that there may be sections in this user manual, which are not relevant to your product, since this manual applies to all existing modules (on the date of printing).

Electrical adjustment options

 Refer to the user manual for your remote for more information on operating electrical adjustment options

Recaro® seats and AJ Optimist seats

 For more information on a Recaro® seat or AJ Optimist seat, refer to the separate user manuals that come with the seats.

5.2 Adjustment Possibility for Remote

The following information is valid for all seating systems.



CAUTION!

Risk of the remote being pushed backwards during an accidental collision with an obstacle, such as a doorframe or table, and the joystick being jammed against the armpad if the position of the remote is adjusted and all screws are not completely tightened

This will cause the mobility device to drive forward uncontrollably and potentially injure the mobility device user and any person standing in the way.

- When adjusting the position of the remote, always make sure to tighten all screws securely.
- If this should accidentally happen, immediately switch the mobility device electronics OFF at the remote.



CAUTION!

Risk of Injury

When leaning on the remote, for example, when transferring into or out of the wheelchair, the remote holder may break and the user may fall out of the chair.

- Never lean on the remote as a support for, for example, transfer.

5.2.1 Adjusting Remote for Length of User's Arm

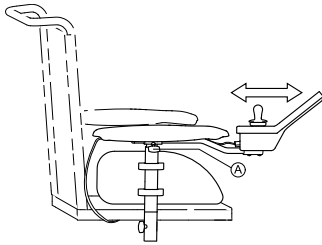

Fig. 5-1

1. Loosen wing screw (A).
2. Adjust component to desired position.
3. Tighten wing screw.

5.2.2 Adjusting Remote Height (only for Swing-Away Remote Supports)



- 6 mm Allen key

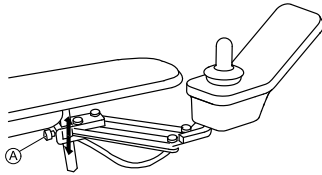

Fig. 5-2

1. Loosen screw (A).
2. Adjust component to desired position.
3. Tighten screw.

5.2.3 Adjusting Remote Offset

The remote can be adjusted by 20 mm (0.8 inch) sidewise.

1541361-N



- 3 mm Allen key

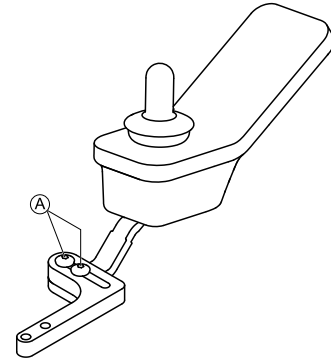

Fig. 5-3

1. Loosen screws (A).
2. Adjust component to desired position.
3. Tighten screws.

5.2.4 Swivelling Remote to Side

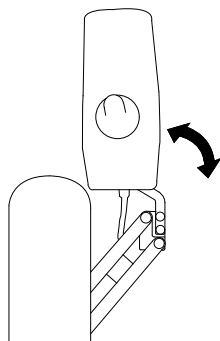

Fig. 5-4

If your mobility device is fitted with a swing-away remote holder, then the remote can be moved away to the side, for example, to drive up close to a table.

5.3 Adjustment options for standard armrests

5.3.1 Changing the arm support position



Tools:

- 1 x Allen key 3 mm

The arm support has 12 possible positions.

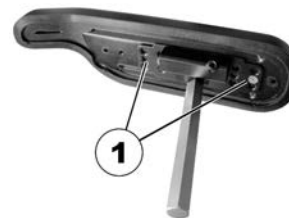

1. To change the position of the arm support, loosen the screw (1) and remove it.
2. The position of the arm support is adjusted by selecting a combination of screw holes in the arm support and the drill holes in the fixing plate.
3. Reposition the screws and tighten.

5.3.2 Setting height of armrests



- 3 mm Allen key

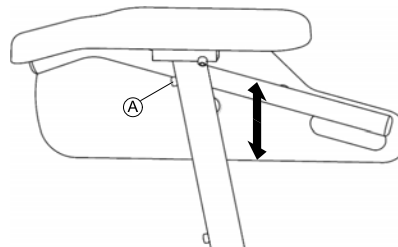

1. Loosen screw (A).
2. Adjust armrest to desired height.
3. Re-tighten screw.

5.3.3 Adjusting width of armrests



WARNING!

Serious risk of injury if one of the armrests falls out of its bracket because they have been adjusted to a width which exceeds the permissible value

- The width adjustment is fitted with red markings **A** and the word "STOP". The armrests must never be pulled out further than the point at which the word "STOP" is completely legible.
- Always tighten the fixing screws properly once adjustments have been completed.

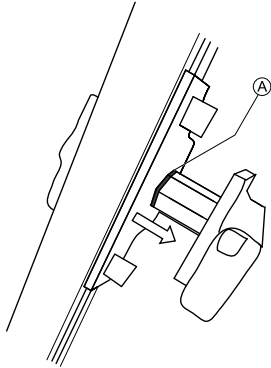

Depending on the side, the screw is accessible from the front or the rear.



- 8 mm Allen key

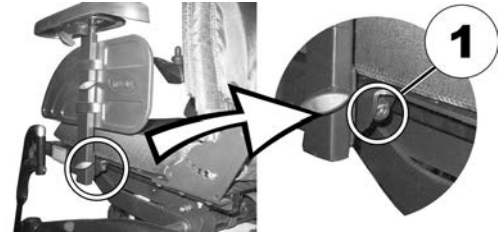

1. Loosen screw (1).
2. Adjust armrest to required position.
3. Re-tighten screw.
4. Repeat this procedure for the second armrest.

5.4 Adjustment options for parallel sliding armrests

5.4.1 Setting the height of the parallel sliding armrests

The height of the parallel sliding armrest is set using the armrest angle.

1.



Release the knob to adjust the armrest angle (1).

2.



Set the angle for the armrest.

3. Retighten the knob.

After adjusting the armrest height, the angle of the armpad needs to be adjusted. Refer to *5.4.2 Adjusting angle of armpad on parallel sliding armrests, page 32.*

5.4.2 Adjusting angle of armpad on parallel sliding armrests



- 5 mm Allen key
-

1.



Loosen screws (1).

2.



Set angle for armrest.

3. Re-tighten screws. Make sure that Nordlock washers used are re-inserted.

5.4.3 Adjusting the width of the parallel sliding armrests

The parallel sliding armrests can be adapted to the backrest in eight widths.



Tools:

- 4 mm Allen key
-

1.



Undo the bolts on both sides of the backrest cover (1). The photograph only shows the bolts on the left-hand side.

2. Remove the backrest cover (2).

3.

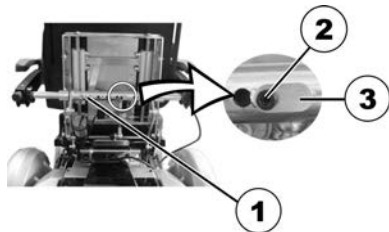

On the torque support, loosen the locating pin (3) bolt (2) with the Allen key.

4. Reduce the load on the armrest by raising it slightly and then remove the locating pin.

5.



Adjust the armrest width.

The possible positions for the armrest are predefined by the drill-holes in the torque support and the armrest axle.

6. Insert the locating pin.

7. Retighten the screw.

8. Repeat the procedure for the other armrest.

9.



Replace the backrest cover (2). When doing so, ensure that the recesses in the sides are located correctly.

10. Retighten the bolts on both sides of the backrest cover (1) again.

The photograph only shows the bolts on the left-hand side.

5.4.4 Adjusting the mobility of the parallel sliding armrests

The flexibility of the parallel sliding armrest can be adjusted to easier or stiffer.



Tools:

- 5 mm Allen key

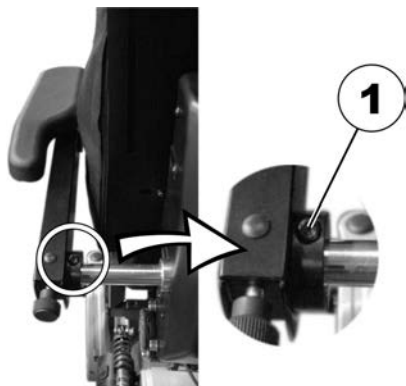

1. To make the armrest easier to move, release the bolt of the adjusting wrench (1) with the Allen key.
2. To make the armrest more difficult to move, tighten the bolt of the adjusting wrench (1) with the Allen key.

5.4.5 Adjusting the arm support positions for the parallel sliding armrests



Tools:

- 5 mm Allen key

1.

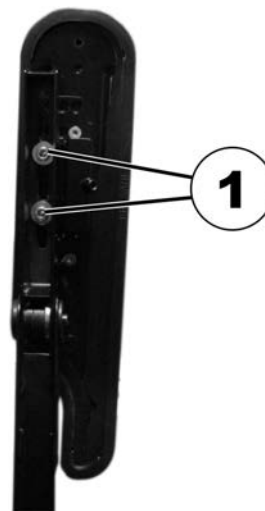

- Put the armrest in the vertical position.
2. Release the interior bolts (1) with the Allen key.

3.

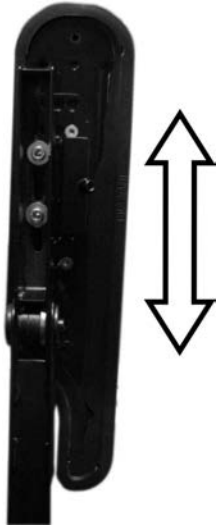

Position the armrest horizontally.

4. Re-tighten the bolts.
Make sure that the Nordlock washers used are re-inserted.

5.5 Adjusting Manual Chin Control



WARNING!

Risk of Injury or Death

Small parts can lead to choking hazard that may result in injury or death.

- Do not remove any small parts.
- Closely supervise children, pets or people with physical/mental disabilities.



CAUTION!

Risk of Injury and Damage

Remaining burrs and missing end caps after modifications on rods, such as shortened rod, can lead to injury or damage.

- Deburr cut after cutting excessive length.
- Re-install end cap after deburring.
- Check end cap for tight fitting.

5.5.1 Adjusting Extremity Control Joystick

Adjusting Joystick Orientation

The joystick can be turned through 360 degrees. A slot on the side allows you to angle the joystick at 90 degrees.

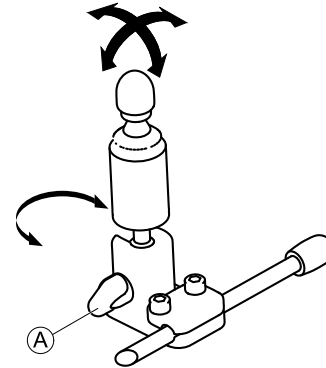



Fig. 5-5

1. Loosen hand screw (A).
2. Turn underpart of joystick to position slot.

3. Adjust joystick orientation. If desired, lock joystick in 90 degree angle in slot.
4. Tighten hand screw.

Adjusting Position on Holder

-  • 5/32 inch Allen key

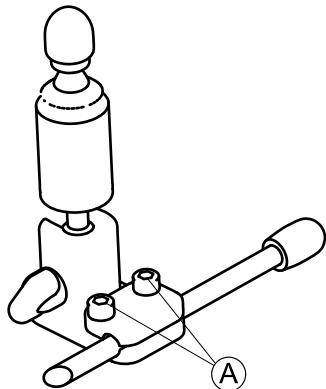

Fig. 5-6

1. Loosen screws (A).
2. Position joystick on holder.
3. Tighten screws.

Adjusting Depth and Height

Refer to 5.5.3 *Adjusting Swing-Away Mechanism*, page 36.

5.5.2 Adjusting Egg Switch

Adjusting Switch Orientation

The egg switch can be turned through 360 degrees.



- 7/16 inch wrench

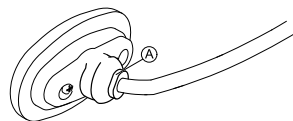

Fig. 5-7

1. Loosen nut (A).
2. Adjust egg switch orientation.
3. Tighten nut.

Adjusting Depth and Height

Refer to 5.5.3 *Adjusting Swing-Away Mechanism*, page 36.

5.5.3 Adjusting Swing-Away Mechanism



WARNING!

Risk of Injury or Death

Small parts can lead to choking hazard that may result in injury or death.

- Do not remove any small parts.
- Closely supervise children, pets or people with physical/mental disabilities.

**CAUTION!****Risk of Injury and Damage**

Remaining burrs and missing end caps after modifications on rods, such as shortened rod, can lead to injury or damage.

- Deburr cut after cutting excessive length.
- Re-install end cap after deburring.
- Check end cap for tight fitting.

The swing-away mechanism can be used for different options such as:

- PROTON wings of head array
- Extremity control joystick for chin control
- Egg switch

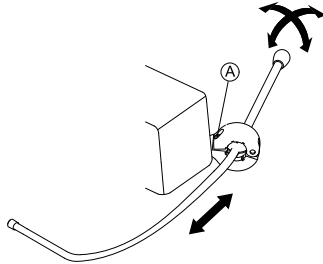

- 5/32 inch Allen key

**Adjusting Depth**

1. Loosen screw Ⓐ.
2. Adjust rod to desired depth.
3. Tighten screw.

Adjusting Position

The swing-away mechanism can be turned through 360 degrees.

1. Loosen screw Ⓐ.
2. Adjust to desired position.
3. Tighten screw.

5.6 Adjusting Powered Chin Control**WARNING!****Risk of Injury or Death**

Small parts can lead to choking hazard that may result in injury or death.

- Do not remove any small parts.
- Closely supervise children, pets or people with physical/mental disabilities.

**CAUTION!****Risk of Injury and Damage**

Remaining burrs and missing end caps after modifications on rods, such as shortened rod, can lead to injury or damage.

- Deburr cut after cutting excessive length.
- Re-install end cap after deburring.
- Check end cap for tight fitting.

5.6.1 Adjusting Extremity Control Joystick

See “Adjusting Joystick Orientation” in *5.5.1 Adjusting Extremity Control Joystick, page 35*.

5.6.2 Adjusting Joysticks and Switches on Linkage

Positioning Joysticks / Switches



Risk of damage to screws

If you tighten screws to an improper torque, they might either come loose or get damaged.
– Tighten the screws to a torque of 3 Nm ± 10 %.



- 4 mm Allen key

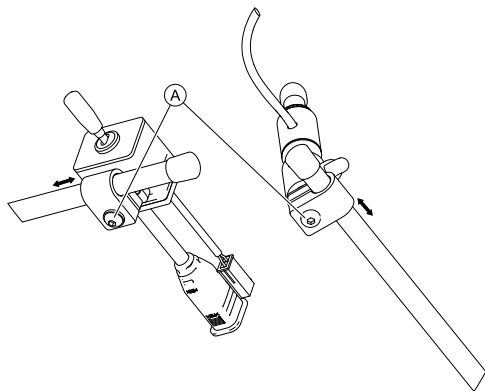

Fig. 5-8

1. Loosen screws Ⓐ.
2. Move joystick or switch to desired position on the linkage.
3. Tighten screws.

Positioning Piko Buttons



Risk of damage to screws

If you tighten screws to an improper torque, they might either come loose or get damaged.
– Tighten the screws to a torque of 3 Nm ± 10 %.



- 4 mm Allen key
- 7/16 inch wrench

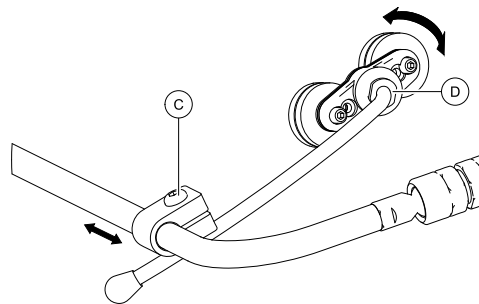

Fig. 5-9

1. Loosen screw Ⓒ.
2. Move holder to desired position.
3. If necessary, loosen nut Ⓓ.
4. Adjust holder orientation.
5. Tighten screw Ⓒ and nut Ⓓ.

Adjusting Height And Depth of Linkage



- 3 mm Allen key

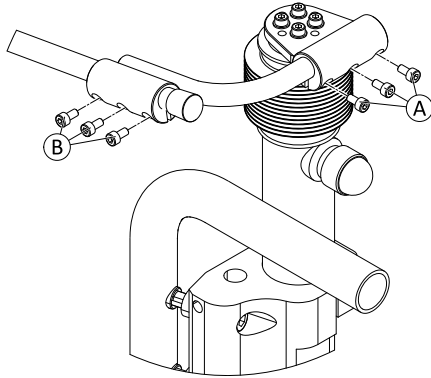



Fig. 5-10

1. Loosen screws **A** (height adjustment) or **B** (depth adjustment).
2. Move linkage to desired position.
3. Tighten screws.

Adjusting Linkage Orientation

 This section only applies to variants with ball joints.

You can additionally adjust the position of joysticks and remote via ball joints in the linkage. The ball joints are freely movable and offer you infinite adjustment possibilities.

- ! Risk of damage to ball joints**
If you tighten ball joints to an improper torque, they might either come loose or get damaged.
– Tighten the ball joints to a torque of 35 Nm.



- 19 mm wrench (2x)

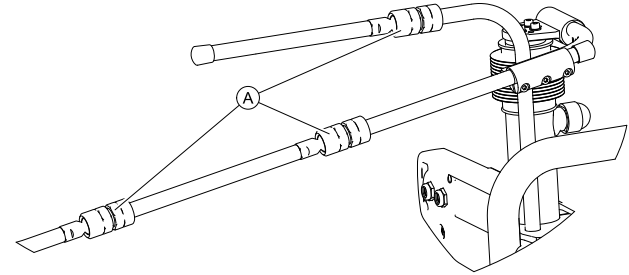
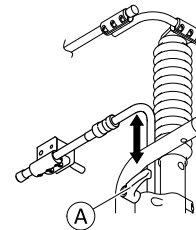

Fig. 5-11

1. Loosen ball joint **A**.
2. Position linkage.
3. Tighten ball joint.

5.6.3 Adjusting Height of Linkage Switch

- ! Risk of damage to clamping lever**
If you tighten clamping lever to an improper torque, it might either come loose or get damaged.
– Tighten clamping lever only hand-tight.



1. Loosen clamping lever (A).
2. Adjust height of linkage switch.
3. Tighten clamping lever.

5.7 Adjustment Options for Modulite Seat Unit

5.7.1 Adjusting Armrest Height

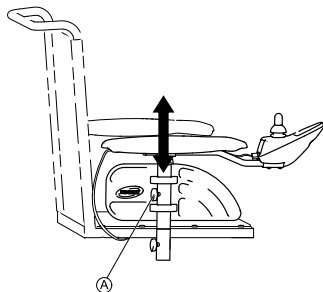

Fig. 5-12

1. Loosen wing screw (A).
2. Adjust component to desired position.
3. Tighten wing screw.

5.7.2 Adjusting Armrest Width



WARNING!

Serious injury hazard if one of the armrests falls out of its bracket because they have been adjusted to a width which exceeds the permissible value

- The width adjustment is fitted with red markings (A) and the word "STOP". The armrests must never be pulled out further than the point at which the word "STOP" is completely legible.
- Always tighten the fixing screws properly once adjustments have been completed.

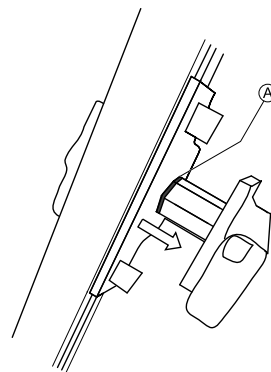

Fig. 5-13



Depending on the side, the screw is accessible from the front or the rear.



- 8 mm Allen key

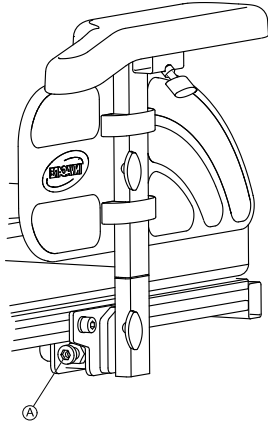

Fig. 5-14

1. Loosen screw Ⓐ.
2. Adjust component to desired position.
3. Tighten screw.

5.7.3 Adjusting Armrest Depth



- 6 mm Allen key

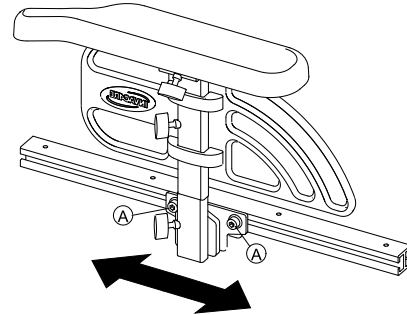

Fig. 5-15

1. Loosen screws Ⓐ .
2. Adjust component to desired position.
3. Tighten screws.

5.7.4 Adjusting Seat Width

The telescopic seat support can be adjusted in four stages. The seat width can thus be adjusted together with the adjustable seat plate or the adjustable sling seat.

The description of how the width is adjusted is contained in the service manual for this mobility device. The service manual can be ordered from Invacare. However, they contain instructions for specially trained service technicians and describe operations that are not intended for the end user.

5.7.5 Adjusting the seat depth



CAUTION!

Increased risk of tipping because of too short seat depth

With seat depths below 41 cm, the tipping stability of the wheelchair gets worse and there is a higher risk, in certain situations, of falling onto the anti-tipping wheels.

- Choose a seat depth of at least 41 cm.
- Shorter seat depths are prevented by a tightly fastened screw on the seat profile. NEVER remove this screw.



The seat depth has a major influence on the selection of the center of gravity of the seat. This impacts its dynamic stability. If you make a major change to the seat depth the center of gravity of the seat must also be adjusted. See "Adjusting the center of gravity of the seat" in the service instructions for this mobility device. The service instructions can be ordered from Invacare. However, they contain instructions for specially trained technicians and describe operations that are not intended for the end user.



The numbers on the scale on the seat serve as a guide. They do not stipulate any dimensions such as seat depth in centimeters.



Tools:

- 6 mm Allen key

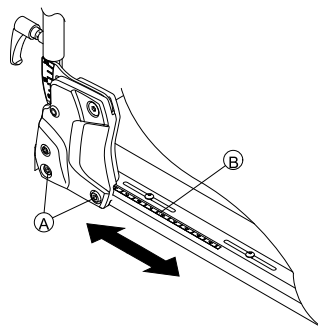

1. On both sides, loosen the bottom backrest screw (A). Do not remove the screws!
2. Move the backrest to the required seat depth. You can adjust the seat depth steplessly. Use scale (B) on the seat as a guide for this purpose. Ensure that the same seat depth is set on both sides.
3. Re-tighten the screws.

5.8 Adjusting the seat angle



CAUTION!

Adjusting the seat tilt or the backrest angle changes the geometry of the mobility device and directly influences its dynamic stability!

- For details regarding dynamic stability, negotiating gradients and obstacles and the correct adjustment of seat tilt or backrest angle, refer to 6.3 *Taking Obstacles*, page 81 and 6.4 *Driving up and down Gradients*, page 83.

5.8.1 Manual

You can set the seat angle manually to 0°, 4° or 8°. The factory setting is 4°.

The seat angle is adjusted using four perforated strips which are located under the seat frame.

 Activate the motor brakes (engage motor) before adjusting the seat angle.

Only adjust the seat angle manually if nobody is sitting in the seat.



Tools:

- 6 mm Allen key

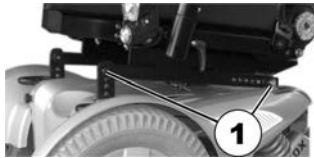

The picture shows the position of the screws (1) for the manual adjustment of the seat angle.

1. Loosen the bolts on both sides.
2. Loosen and remove the bolts at the front.
3. Set the desired angle.
4. Retighten the bolts.

5.9 Adjusting Backrest



CAUTION!

Adjusting the seat tilt or the backrest angle changes the geometry of the mobility device and directly influences its dynamic stability!

– For details regarding dynamic stability, negotiating gradients and obstacles and the correct adjustment of seat tilt or backrest angle, refer to 6.3 *Taking Obstacles*, page 81 and 6.4 *Driving up and down Gradients*, page 83.

5.9.1 Adjusting the backrest (standard seat) — manually with splint-pins

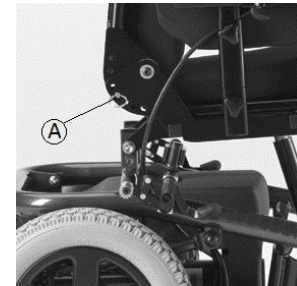

1. Remove splint-pin **A** on both sides of the backrest that hold it in position.
2. Set the backrest to the desired angle by selecting a combination of one of the two holes in the backrest frame, and one of the six holes in the metal fixation plate.
3. Re-position splint-pins **A** and tighten them.

5.9.2 Adjusting the back seat angle on the Easy-Adapt seating system



1. Adjust the angle by turning the hand wheel (1).

5.9.3 Adjusting Backrest Height

The following section describes the procedures for adjusting the height of the backrest plate.



The sling back is only available in fixed heights of 48 and 54 cm.



- 5 mm Allen key

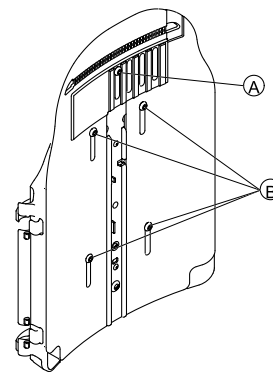



Fig. 5-16

1. Loosen screws Ⓐ and Ⓑ.
 Do not remove screws Ⓐ and Ⓑ.
2. Adjust component to desired position.
3. Tighten screws.

5.9.4 Adjusting Backrest Width

You can adjust the backrest plate width to a certain degree by adjusting the front plate, e.g. in order to adjust the backrest plate in line with the seat cushion. Fairly large adjustments must be made by a service technician to the rear plate and are outlined in the service manual for this mobility device.



The sling back is only available in two widths of 38-43 cm and 48-53 cm and, under certain circumstances, must be replaced for a width adjustment. For a replacement description, see the service manual for this mobility device. The service manual can be ordered from Invacare. However, they contain instructions for specially trained service technicians and describe operations that are not intended for the end user.

Note that if the sling back width is adjusted the backrest cushion must also be replaced.



- 5 mm Allen key

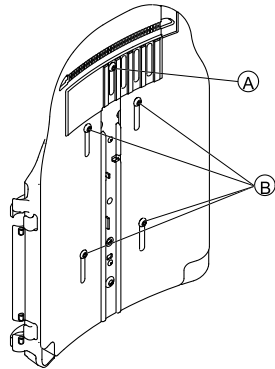

Fig. 5-17

1. Loosen and remove screw **A**.
2. Loosen screws **B**.



Do not remove screws **B**.

3. Adjust component to desired position.
4. Insert screw **A**.
5. Tighten screws.

5.9.5 Adjusting Backrest Angle



CAUTION!

Every change to the seat angle and the backrest angle alters the geometry of the power wheelchair and affects its dynamic stability

- For more information on stability, overcoming obstacles correctly, driving along inclines and slopes and the correct position of the backrest and seat angles, see the section 6.3 *Taking Obstacles*, page 81 and 6.4 *Driving up and down Gradients*, page 83.



CAUTION!

Risk of falling out of the wheelchair

- When adjusting the backrest, it might move backward unexpectedly and you might fall out of the wheelchair.
- Do not rest against the backrest while adjusting it.



If the backrest is fitted with knobs instead of Allen screws, you do not need tools.

Width-Adjustable Backrest



- 6 mm Allen key

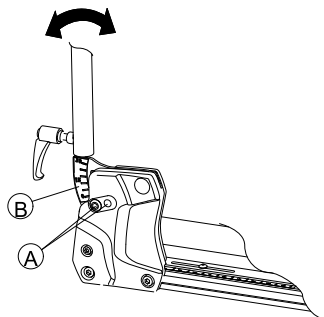

Fig. 5-18

1. Loosen and remove upper backrest screw (A) on both sides.
2. Adjust desired backrest angle in 3.8° steps. Use scale (B) on backrest for this purpose. Ensure that you set same angle on both sides.
3. Insert and tighten screw. Ensure you insert screw through one of holes of backrest bracket. Screw must be visible on inside of bracket and screw head must be flush with bracket.

Simple Backrest



- 6 mm Allen key

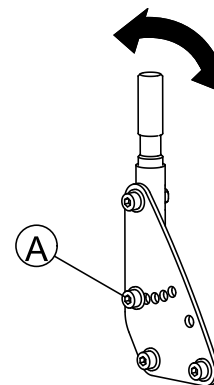

Fig. 5-19

1. Loosen and remove middle backrest screw (A) on both sides.
2. Adjust desired backrest angle in 7.5° steps. Ensure that you set same angle on both sides.
3. Insert and tighten screw.

5.9.6 Adjusting the adaptable backrest padding

There are two ways of adapting the backrest padding.

- Using a snap buckle which is accessible without having to remove the backrest cushion. Please see **Method 1**.
- With adjustment straps which are adjustable using Velcro. Please see **Method 2**.

Method 1

1. Open the Velcro straps on the left-hand side of the backrest cushion.
- 2.

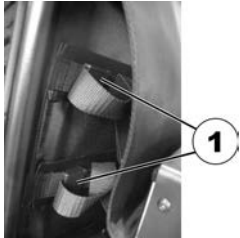

Open the individual snap buckles (1) on the adjustment straps.

3. Adjust the strap tension as required and then close the snap buckle again.
4. Close the backrest cushion Velcro fastenings again.

Method 2

- 1.

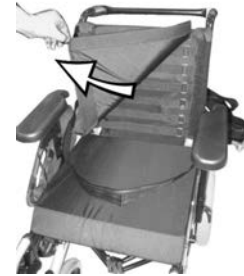

Remove the backrest cushion (fixed with Velcro straps) by pulling it up and away so that you can access the adjusting straps.

- 2.



Adjust the tension of the individual straps as required.

3. Replace the backrest cushion.

5.10 Adjusting Rea Headrest



CAUTION!

Risk of injury during use of the mobility device as a vehicle seat if a headrest is wrongly adjusted or not installed

This can cause the neck to be hyperextended during collisions.

- A headrest must be installed. The headrest optionally supplied for this mobility device by Invacare is perfectly suitable for use during transport.
- The headrest must be adjusted to the user's ear height.

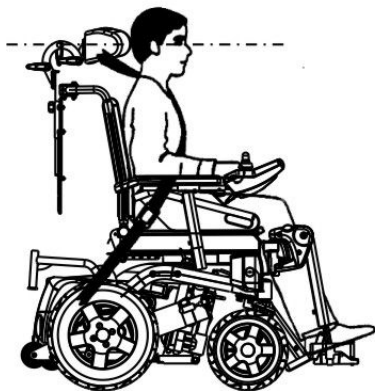

5.10.1 Adjusting Position of Rea Headrest or Neckrest

The adjustment of the position is the same for all Rea headrests and neckrests.



- 5 mm Allen key

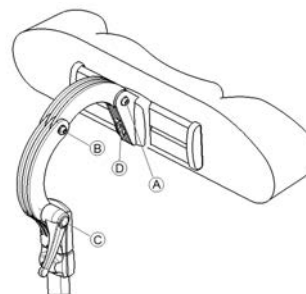

1. Loosen the screws **A** , **B** or the clamping lever **C**.
2. Adjust the headrest or neckrest to the required position.
3. Retighten screws and clamping lever.
4. Loosen the Allen screw **D**.
5. Slide the headrest left or right to the required position.
6. Retighten the Allen screw.

5.10.2 Adjusting Height of Rea Headrest or Neckrest

The adjustment of the height is the same for all Rea headrests and neckrests.

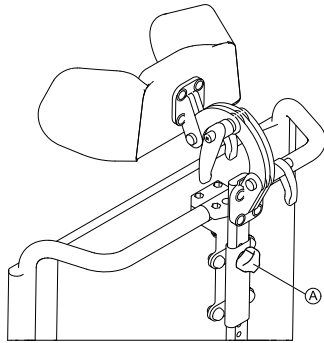

Fig. 5-20

1. Loosen hand screw **A**.
2. Adjust component to desired position.
3. Tighten hand screw.

5.10.3 Adjusting Cheek Supports



Fig. 5-21

1. Push components inward or pull components out to desired position.

5.11 Adjusting Elan Headrest

The headrest clamp hardware is designed to install into existing mounting holes in the backrest pan.



CAUTION!

Risk of injury during use of the mobility device as a vehicle seat if a headrest is wrongly adjusted or not installed

This can cause the neck to be hyperextended during collisions.

- A headrest must be installed. The headrest optionally supplied for this mobility device by Invacare is perfectly suitable for use during transport.
- The headrest must be adjusted to the user's ear height.

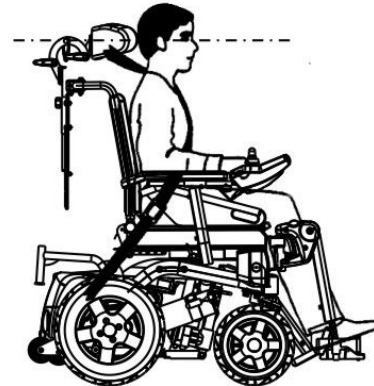

Fig. 5-22



- It may be necessary to remove and modify the back cushion cover in order to access the headrest mounting holes on the back pan.
- An optional shim plate is available. It may be installed between the clamp assembly and the back pan to provide additional spacing/clearance on Posture Back and Deep Back.

5.11.1 Adjusting Elan Headrest Hardware

Elan headrest hardware is highly adjustable. The illustration below shows the possible adjustment ranges of the joints.

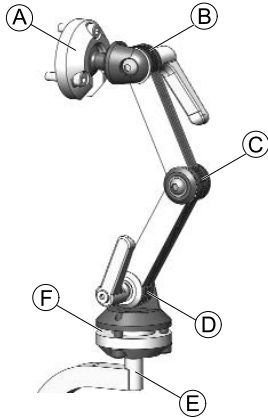

Fig. 5-23

Ⓐ	Upper multi-angle rotational pivot	<ul style="list-style-type: none"> • 360° rotation • 80° tilt
Ⓑ	Upper linkage	<ul style="list-style-type: none"> • 180° rotation

Ⓒ	Middle linkage	<ul style="list-style-type: none"> • 100° rotation
Ⓓ	Lower linkage	<ul style="list-style-type: none"> • 180° rotation
Ⓔ	Mounting post	<ul style="list-style-type: none"> • 360° rotation in 90° increments
Ⓕ	Lower multi-angle rotational pivot	<ul style="list-style-type: none"> • 360° rotation • 50° tilt

Installing



- 2.5 mm Allen key
- 4 mm Allen key
- 5 mm Allen key

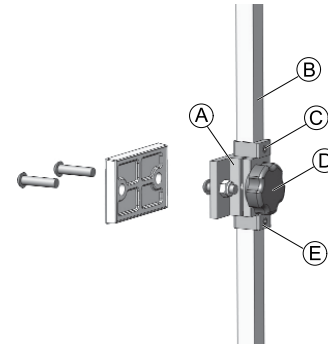

Fig. 5-24

1. Using hardware provided, align and install headrest clamp assembly into existing mounting holes in backrest pan **A**.
2. Install headrest pad (not shown) to headrest rod using mounting hardware provided.



The headrest pad can be adjusted to any desired angle via the pivot ball at the end of the headrest rod by loosening and tightening the mounting hardware.

3. Loosen and remove lower D-Ring **E** from hardware.
4. Slide vertical mounting post **B** into clamp assembly and adjust overall height of headrest pad to desired position. Tighten knob **D**.
For proper set-up headrest should be adjusted to user's ear height.
5. Adjust upper D-Ring **C** as required.
6. Once final height position is set, adjust lower D-Ring **E** so that it rests flush with bottom of clamp assembly (to prevent slipping).

Adjusting Depth and Angle

The headrest can be further adjusted for depth and angle via the articulating hardware.



- 4 mm Allen key
- 5 mm Allen key

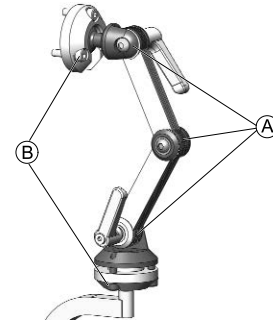

Fig. 5-25

1. Loosen screws and clamping levers of dual link adjustment assembly **A** and screws of upper and lower rotational pivots **B**.
2. Adjust component to desired position.
3. Tighten screws and clamping levers.

5.12 Adjusting the trunk support (Easy-Adapt seating system)

The trunk supports can be adjusted in width, height and depth.

5.12.1 Adjusting the width



1. Loosen the handscrews (1).
2. Adjust the trunk support to the required width.
3. Retighten the handscrews again.

5.12.2 Adjusting the height



Tools:

- 5 mm Allen key



1. Undo the height adjustment Allen screws (1).
2. Set the trunk support to the required height.
3. Retighten the screws.

5.12.3 Adjusting the depth



Tools:

- 5 mm Allen key



1. Open the zip.
2. Undo the screws (1) for the depth adjustment.
3. Adjust the trunk support to the required position.
4. Retighten the screws.
5. Close the zip again.

5.13 Adjusting/Removing Tray



CAUTION!

Risk of injury or material damage if a mobility device which is fitted with a tray is transported in a vehicle

- If a tray is fitted, always remove it before transporting the mobility device.



Fig. 5-26

5.13.1 Adjusting Tray Laterally

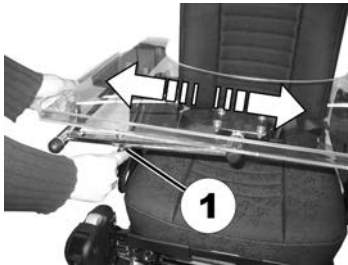

Fig. 5-27

1. Loosen wing screw (1).
2. Adjust component to desired position.
3. Tighten wing screw.

5.13.2 Adjusting Depth of Tray/Removing Tray

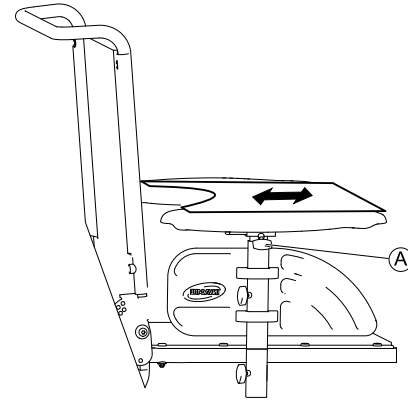

Fig. 5-28

1. Loosen wing screw (A).
2. Adjust component to desired position (or remove it entirely).
3. Tighten wing screw.

5.13.3 Swinging Tray Away to Side

The tray can be swivelled up and away to the side to allow the user to get in and out of the mobility device.

**CAUTION!**

Risk of injury! When the tray is raised it does not lock in place in this position!

- Do not tilt the tray up and leave it leaning in this position.
- Never attempt to drive with the tray tilted up.
- Always lower the tray in a controlled manner.

5.14 Seat support

5.14.1 Adjusting seat width



Also refer to the following chapter entitled *5.14.2 Adjusting the seat depth, page 55.*

The seat width can be adjusted in stages between 380 and 530 mm.



Tools:

- 4 mm Allen key

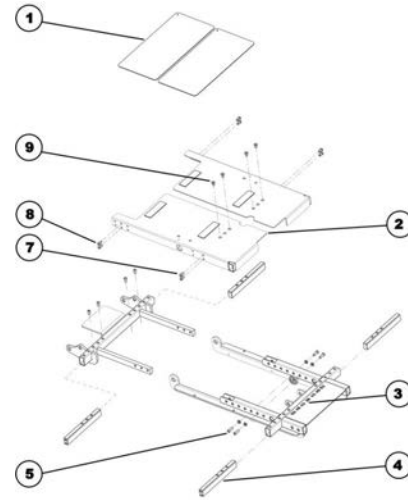
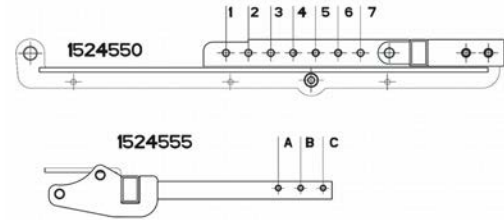

Fig. 5-29 Exploded drawing of seat support

1. Remove the seat cushion.
2. Remove the cover plates (1).
3. Undo the two Allen screws (6) at the rear on the crossmember and remove them.
4. Undo the two Allen screws (9) at the front on the seat support plate and remove them.
5. Loosen the four Allen screws (7) and (8) which are located at the front and back to the sides of the seat support plate to release tension so that the plate can be moved more easily. Do not, however, remove these screws completely.

6. Pull or push the seat support plate (2) the required width. A scale (3) has been fitted to the bottom part of the seat support. Use this scale to read off the seat width in centimeters.
7. Repeat these operations on the other side of the seat.
8. Now tighten all the screws again.



5.14.2 Adjusting the seat depth



Also refer to the previous chapter entitled *5.14.1 Adjusting seat width, page 54.*

The seat depth can be adjusted in stages between 380 and 530 mm.



Tools:

- 4 mm Allen key
- 8 mm jaw spanner
- oblique pliers
- cable binder



Particular holes in the seat support must be used to the screws depending on the required seat depth. It may also be necessary to replace the seat support plate.

1. Please use the following figures and the table to determine which holes need to be used for the required seat depth, and therefore whether the seat support plate needs to be replaced or not.

Seat depth in cm	Holes used in front seat frame order no.: 1524550	Holes used in rear seat frame order no.: 1524555	Seat support plate required
38	6 & 7	A & B	SHORT order no. 1526437
41	5 & 7	A & C	
43	4 & 6	A & C	
43	4 & 6	A & C	MEDIUM order no. 1526438
46	3 & 5	A & C	
48	2 & 4	A & C	
48	2 & 4	A & C	LONG order no. 1526439
51	1 & 3	A & C	
53	1 & 2	B & C	

2. Adjust the seat depth as described in the following chapter:
 - If the seat support plate does not need to be replaced, please refer to chapter *5.14.3 Adjusting the seat depth without replacing the seat support plate, page 56.*

- If the seat support plate does need to be replaced, please refer to chapter 5.14.4 *Adjusting the seat depth with replacing the seat support plate*, page 57.

5.14.3 Adjusting the seat depth without replacing the seat support plate

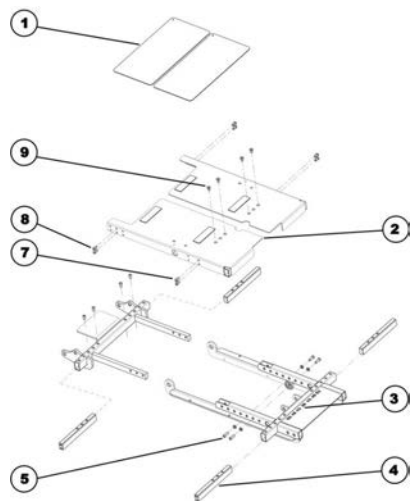

Fig. 5-30 Exploded drawing of seat support

Disassembly

1. Remove the armrests.
2. Remove the seat cushion.
3. Remove the cover plates (1).
4. Undo and remove the two Allen screws (8) which are located on the side at the rear of the seat support plate, and connect these to the crossmembers (4).

5. Repeat these operations on the other side of the seat.
6. Undo and remove the two Allen screws (5) including washers.

Assembly

1. Pull the seat support to the required length so that the Allen screws (5) can be inserted in the holes in accordance with the table (see above).
2. Insert the Allen screws (5) including washers again and tighten them.
3. Fit the two Allen screws (8) which are located at the rear of the seat support, and connect them with the crossmembers (4). You must be using other holes within the 3 hole pairs for the screws than you did during dismantling.
4. Refit all the parts you have removed.

5.14.4 Adjusting the seat depth with replacing the seat support plate

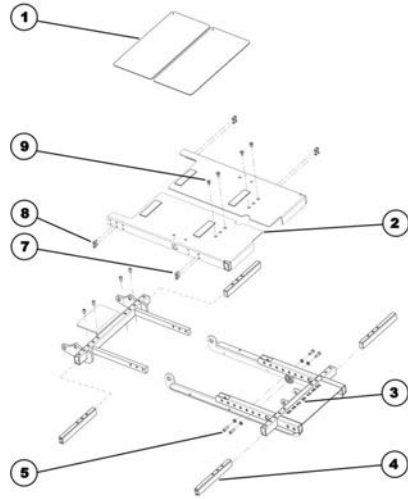

Fig. 5-31 Exploded drawing of seat support

Disassembly

1. Remove the legrests.
2. Remove the armrests.
3. Remove the seat cushion.
4. Remove any cable ties which hold cables from the remote or lighting which have been fitted. Remove the cables from any clips which have been glued on.
5. Undo the cap nuts on the headlight holders with an 8 mm jaw spanner.
6. Place the headlights including their holders safely on the rear section of the battery box cover.

7. Remove the cover plates (1).
8. Undo the two Allen screws (9) at the front on the seat support plate and remove them.
9. Undo the two Allen screws (7) which are located on the side at the front of the seat support plate, and connect these to the crossmembers (4).
10. Undo the two Allen screws (8) which are located on the side at the rear of the seat support plate, and connect these to the crossmembers (4).
11. Remove the seat support plate (2).
12. Repeat these operations on the other side of the seat.
13. Undo and remove the two Allen screws (5) including washers.

Assembly

1. Pull the seat support to the required length so that the Allen screws (5) can be inserted in the holes in accordance with the table (see above).
2. Insert the Allen screws (5) including washers again and tighten them.
3. If necessary, replace the seat support plate (2) in accordance with the table (see above).
4. Put the seat support plate (2) back in position.
5. Fit the two Allen screws (7) which are located at the front of the seat support, and connect them with the crossmembers (4).
6. Fit the two Allen screws (8) which are located at the rear of the seat support, and connect them with the crossmembers (4). It may be necessary to use other holes in the 3 hole pairs for the screws than you did while dismantling the old plate.

7. Fit the two Allen screws (9) at the front of the seat support plate.
8. Refit all the parts you have removed.

5.15 Backrest unit with ergonomic length compensation (Easy-Adapt)

5.15.1 Adjusting the width

 Also refer to the previous chapter entitled *5.14.1 Adjusting seat width, page 54.*

The seat can be adjusted in stages between 380 and 530 mm.



Tools:

- 4 mm Allen key

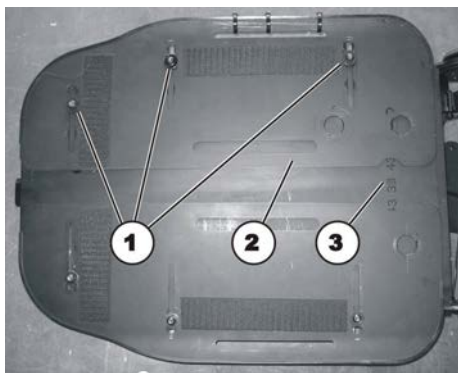

1. Remove the backrest cushion.
2. Loosen the three Allen screws (1). Do not, however, remove these screws completely.

3. Push the plate (2) as far as required until the required width in cm can be read off the scale (3).
4. Tighten the three Allen screws again.
5. Repeat these operations on the other backrest plate.
6. Attach a backrest cushion of the required width.

5.16 Center-mounted legrests — manually adjustable

5.16.1 Removing the legrest

You can remove central, manually adjustable legrest completely.

1.

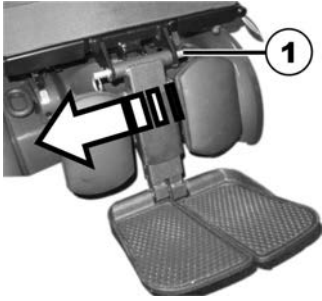

Remove removable axle (1).

2.

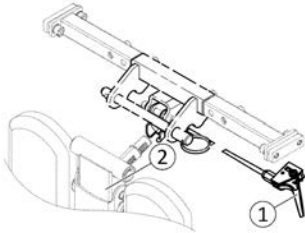

Hold legrest securely and pull lever (1).

3. Remove legrest from holder (2).

5.16.2 Setting the angle of the leg rest



CAUTION!

Risk of injury

If the leg rest is not secured and the lever (1) is removed, the leg rest will drop suddenly, which could cause an injury.

– Secure the leg rest before you remove the lever to adjust the angle of the leg rest.



1. Hold the leg rest securely.
2. Pull the lever (1).
3. Push the leg rest into the required position.

5.16.3 Setting Length of Legrest



- 3/16 inch Allen key

You can adjust the length of the legrests independently of one another.



Fig. 5-32

1. Release the bolts (1) on the rear of the legrest using the Allen key.
2. Set the desired length.
3. Retighten the bolts.

5.16.4 Setting Angle of Foot Plate



- 5/32 inch Allen key



Fig. 5-33

1. Fold the foot plates up in order to access the adjusting screws (1).
2. Set the adjusting screws using the Allen key.
3. Fold the foot plate down again.

5.16.5 Setting Angle and Height of Calf Pad



- 3/16 inch Allen key



Fig. 5-34

1. Fold the calf pad forward in order to access the bolt (1).
2. Loosen the bolt using the Allen key and adjust the calf pad to the required angle and height.

3. Retighten the bolt.
4. Fold the calf pad back.

5.17 LNX legrest

5.17.1 Setting the length of the legrest

If needed, the legrest can be pre-set to 83° or 97° instead of 90°. Contact your Invacare provider.



- 4 mm Allen key
- 10 mm open-ended wrench

You can adjust the length of the legrests independently of one another.

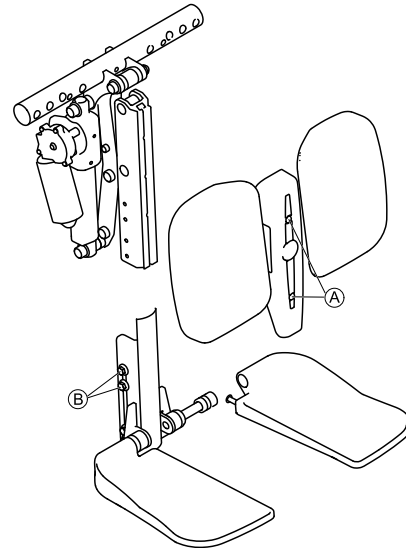

1. Remove screws **A** at the front of legrest.
2. Remove cover together with calf pads.
3. Loosen nuts **B** at the side of legrest.
It may be necessary to remove the nuts and move them from one slot to the other.
4. Set desired length.
5. Retighten nuts.
6. Refit the calf pads and cover and retighten screws.

 The legrest with foot platform is adjusted the same way.

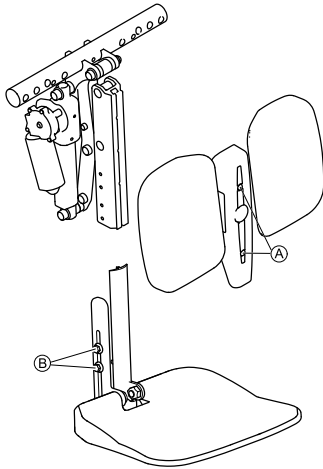

5.17.2 Setting Angle of Foot Plate



- 5/32 inch Allen key



Fig. 5-35

1. Fold the foot plates up in order to access the adjusting screws (1).
2. Set the adjusting screws using the Allen key.
3. Fold the foot plate down again.

5.17.3 Setting Height and Width of Calf Pad



Risk of damage to the mobility device

- After changing the configuration of the calf pads make sure that the calf pads contact neither the casters nor the seat plate when adjusting the legrest angle.

Calf pads may be adjusted independently on their respective mounting bracket using the mounting screws at the rear of the calf pads. Calf pads may be adjusted (for depth, height & angle) to achieve a variety of different configurations. The independent pad adjustments provide optimal positioning and comfort for end users - sample configurations are illustrated below.

Calf Pad Adjustment — Sample Configurations

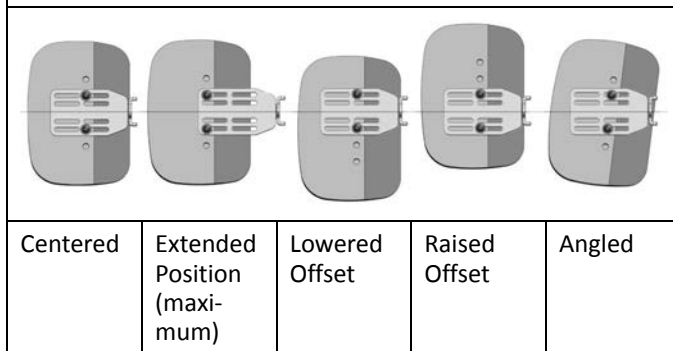

- 4 mm Allen key

1. Fold the calf pad forward in order to access the bolts.
2. Loosen the bolts and remove them if necessary.
3. Adjust the calf pad to the required height and width.
4. Retighten the bolts.
5. Fold the calf pad back.

5.18 Vari-F footrest

5.18.1 Swivelling the footrest/legrest outward and/or removing

The small unlocking button is located on the upper section of the footrest/legrest. When the footrest/legrest is unlocked, it can be swivelled inward or outward when getting into the wheelchair as well as being removed completely.



1. Press the unlocking button (1) and swivel the footrest/legrest outward.
2. Remove the footrest/legrest in an upward direction.

5.18.2 Setting the angle



CAUTION!

Risk of injury due to incorrect adjustment of the footrests and legrests

- Before and during every journey it is imperative to ensure that the legrests contact neither the castor wheels nor the ground.



- 6 mm Allen key

1.



Loosen the screw (1) using the Allen key.

2. If the footrest cannot be moved after loosening the screw, position a metal pin in the designated borehole (2) and use a hammer to knock on this lightly. The clamping mechanism in the interior of the footrest will be released by this. Repeat the procedure from the other side of the footrest if necessary.

3.

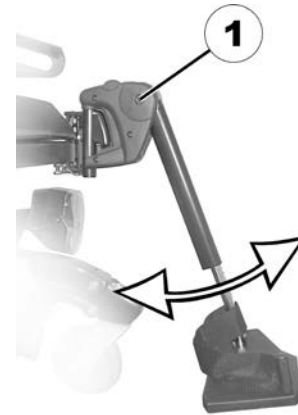

Loosen the screw (1) using the Allen key.

4. Set the desired angle.
5. Re-tighten the screw.

5.18.3 Setting the end stop of the footrest



- 6 mm Allen key
- 10 mm wrench

1.



Fig. 5-36

The end position of the footrest is determined by means of a rubber stop (1).

2.

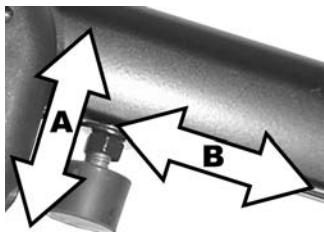

Fig. 5-37

The rubber stop can be screwed in or out (A) or pushed up or down (B).

3.



Fig. 5-38

Use the Allen key to loosen the screw (1) and swivel the footrest upward in order to access the rubber stop.

4.



Fig. 5-39

Use the open-ended spanner to loosen the counter nut (1).

5.

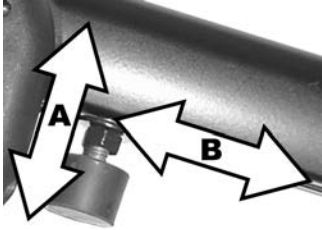

Fig. 5-40

Move the rubber stop to the desired position.

6. Re-tighten the counternut.

7.



Fig. 5-41

Move the footrest to the desired position.

8. Re-tighten the screw.

5.18.4 Adjusting the length of the footrest



CAUTION!

Risk of injury due to incorrect adjustment of the footrests and legrests

– Before and during every journey it is imperative to ensure that the legrests contact neither the castor wheels nor the ground.



- 5 mm Allen key

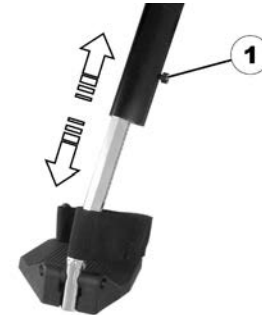

1. Use the spanner to loosen the screw (1).
2. Adjust to the desired length.
3. Re-tighten the screw.

5.19 Vari-A legrests

5.19.1 Swivelling the footrest/legrest outward and/or removing

The small unlocking button is located on the upper section of the footrest/legrest. When the footrest/legrest is unlocked,

it can be swivelled inward or outward when getting into the wheelchair as well as being removed completely.

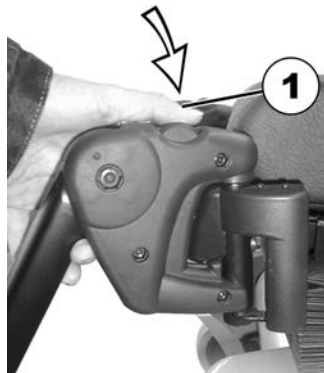

1. Press the unlocking button (1) and swivel the footrest/legrest outward.
2. Remove the footrest/legrest in an upward direction.

5.19.2 Setting the angle



CAUTION!

Risk of injury due to incorrect adjustment of the footrests and legrests

- Before and during every journey it is imperative to ensure that the legrests contact neither the castor wheels nor the ground.

1.

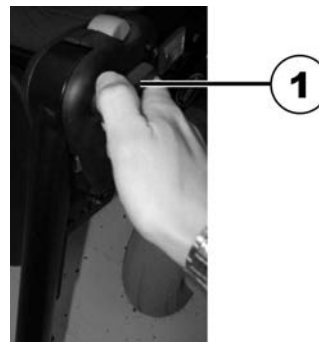

Loosen the locking knob (1) counter-clockwise at least one turn.

2.



Hit the knob to release the locking mechanism.

3.



Set the desired angle.

4.



Turn the knob clockwise to tighten it.

5.19.3 Setting the end stop of the legrest



- 10 mm wrench

1.



The end position of the legrest is determined by means of a rubber stop (1).

2.

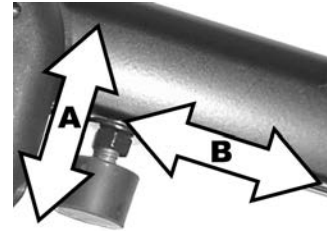

The rubber stop can be screwed in or out (A) or pushed up or down (B).

3.

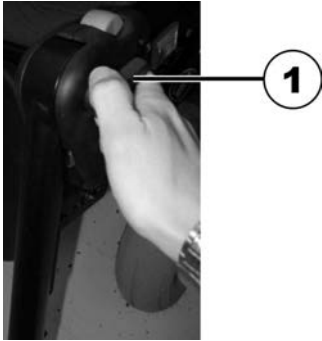

Loosen the locking knob (1) counter-clockwise at least one turn.

4.



Hit the knob to release the locking mechanism.

5.



Swivel the legrest upward in order to access the rubber stop.

6.



Use the wrench to loosen the conical nut (1).

7.

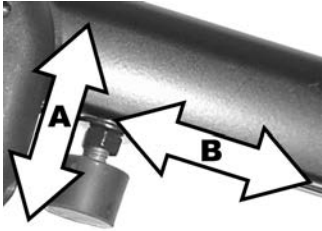

Move the rubber stop to the desired position.

8. Re-tighten the counternut.

9.



Move the legrest to the desired position.

10. Re-tighten the locking knob.

5.19.4 Adjusting the length of the legrest



CAUTION!

Risk of injury due to incorrect adjustment of the footrests and legrests

– Before and during every journey it is imperative to ensure that the legrests contact neither the castor wheels nor the ground.



- 5 mm Allen key

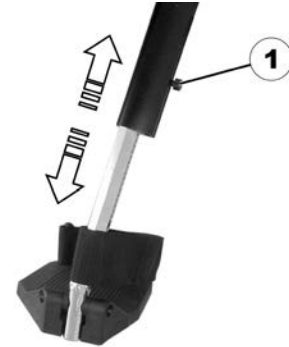

1. Use the spanner to loosen the screw (1).
2. Adjust to the desired length.
3. Re-tighten the screw.

5.19.5 Adjusting the depth of the calf pad

The depth of the calf pad can be adjusted via the holding plate. The holding plate hole combinations allow 5 different depth settings.



- 10 mm wrench

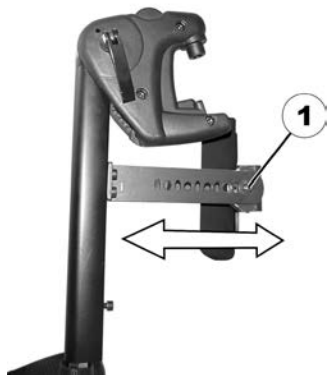

1. Use the wrench to loosen the nut (1) and remove.
2. Adjust to the desired depth. Observe that the round holes are intended for the calf pad retaining screw and the oblong holes for the aglet without thread.
3. Screw the nut back on and tighten.

5.19.6 Adjusting the height of the calf pad



- 4 mm Allen key



1. Use the Allen key to loosen the screws (1).
2. Adjust to the desired position.
3. Re-tighten the screws.

5.19.7 Unlocking and swivelling the calf pad backward when alighting

- 1.



Press the calf pad straight down.

- 2.



Unlock the legrest and swivel outward.
The calf pad swivels backward on its own.

3.



Lift leg over the heel strap and place on the ground.

5.19.8 Adjusting the angle-adjustable foot plate



- 5 mm Allen key

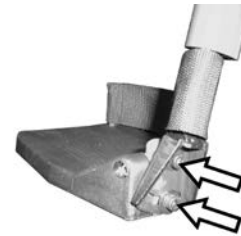

1. Use the Allen key to loosen both set screws on the foot plate.
2. Adjust to the desired angle.
3. Re-tighten the screws.

5.19.9 Adjusting the angle- and depth-adjustable foot plate



- 5 mm Allen key



1. Use the Allen key to loosen the set screw on the foot plate (1).
2. Adjust the foot plate to the desired angle or depth.
3. Re-tighten the screw.

5.20 ADM legrests

5.20.1 Swivelling the legrest outward and/or removing

The small unlocking button is located on the upper section of the legrest. When the legrest is unlocked, it can be swivelled inward or outward when getting into wheelchair as well as being removed completely.



1. Press the unlocking button (1) and swivel the legrest outward.
2. Remove the legrest in an upward direction.

5.20.2 Setting the angle



CAUTION!

Risk of crushing

- Do not reach inside the swivelling range of the legrest.



CAUTION!

Risk of injury due to incorrect adjustment of the footrests and legrests

- Before and during every journey it is imperative to ensure that the legrests contact neither the castor wheels nor the ground.

Raising



1. Pull the legrest upward until the desired angle has been achieved.

Lowering

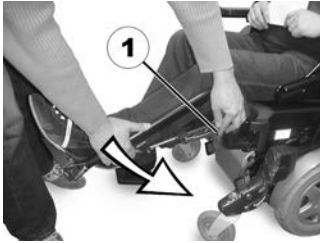

1. Keep the legrest in the foot plate area, pull the lateral adjusting lever (1) and lower the legrest slowly.

5.20.3 Adjusting the length of the legrest



CAUTION!

Risk of injury due to incorrect adjustment of the footrests and legrests

– Before and during every journey it is imperative to ensure that the legrests contact neither the castor wheels nor the ground.



- 5 mm Allen key

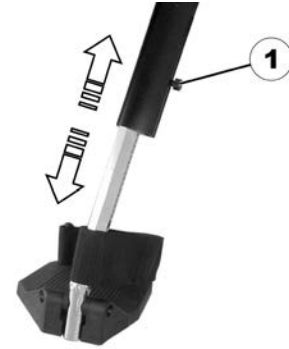

1. Use the spanner to loosen the screw (1).
2. Adjust to the desired length.
3. Re-tighten the screw.

5.20.4 Adjusting the depth of the calf pad

The depth of the calf pad can be adjusted via the holding plate. The holding plate hole combinations allow 5 different depth settings.



- 10 mm wrench

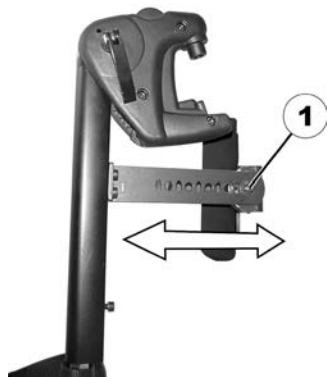

1. Use the wrench to loosen the nut (1) and remove.
2. Adjust to the desired depth. Observe that the round holes are intended for the calf pad retaining screw and the oblong holes for the aglet without thread.
3. Screw the nut back on and tighten.

5.20.5 Adjusting the height of the calf pad



- 4 mm Allen key



1. Use the Allen key to loosen the screws (1).
2. Adjust to the desired position.
3. Re-tighten the screws.

5.20.6 Unlocking and swivelling the calf pad backward when alighting

- 1.



Press the calf pad straight down.

- 2.



Unlock the legrest and swivel outward.
The calf pad swivels backward on its own.

3.



Lift leg over the heel strap and place on the ground.

5.20.7 Adjusting the angle-adjustable foot plate



- 5 mm Allen key

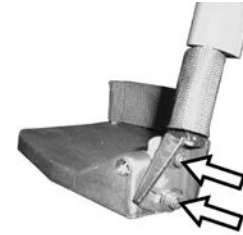

1. Use the Allen key to loosen both set screws on the foot plate.
2. Adjust to the desired angle.
3. Re-tighten the screws.

5.20.8 Adjusting the angle- and depth-adjustable foot plate



- 5 mm Allen key



1. Use the Allen key to loosen the set screw on the foot plate (1).
2. Adjust the foot plate to the desired angle or depth.
3. Re-tighten the screw.

5.21 Powered elevating legrests (ADE legrests)

5.21.1 Swivelling the legrest outward and/or removing

The small unlocking button is located on the upper section of the legrest. When the legrest is unlocked, it can be swivelled inward or outward when getting into wheelchair as well as being removed completely.



1. Press the unlocking button (1) and swivel the legrest outward.
2. Remove the legrest in an upward direction.

5.21.2 Setting the angle



CAUTION!
Risk of crushing

- Do not reach inside the swivelling range of the legrest.



CAUTION!

Risk of injury due to incorrect adjustment of the footrests and legrests

- Before and during every journey it is imperative to ensure that the legrests contact neither the castor wheels nor the ground.

The electrically height-adjustable legrests are operated using the remote. Refer to the separate user manual for your remote for more information.

5.21.3 Adjusting the length of the legrest



CAUTION!

Risk of injury due to incorrect adjustment of the footrests and legrests

- Before and during every journey it is imperative to ensure that the legrests contact neither the castor wheels nor the ground.



- 10 mm wrench

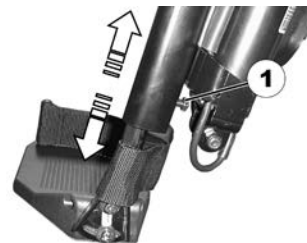

1. Use the wrench to loosen the screw (1).
2. Adjust to the desired length.
3. Re-tighten the screw.

5.21.4 Adjusting the depth of the calf pad

The depth of the calf pad can be adjusted via the holding plate. The holding plate hole combinations allow 5 different depth settings.

-
-  • 10 mm wrench
-

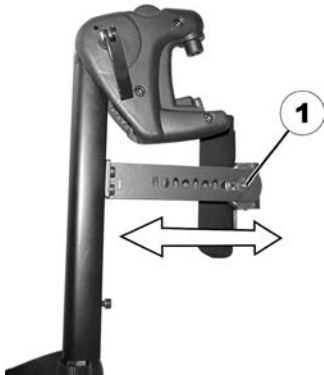

1. Use the wrench to loosen the nut (1) and remove.
2. Adjust to the desired depth. Observe that the round holes are intended for the calf pad retaining screw and the oblong holes for the aglet without thread.
3. Screw the nut back on and tighten.

5.21.5 Adjusting the height of the calf pad

-
-  • 4 mm Allen key
-



1. Use the Allen key to loosen the screws (1).
2. Adjust to the desired position.
3. Re-tighten the screws.

5.21.6 Unlocking and swivelling the calf pad backward when alighting

- 1.



2. Press the calf pad straight down.



Unlock the legrest and swivel outward.
The calf pad swivels backward on its own.

3.



Lift leg over the heel strap and place on the ground.

5.21.7 Adjusting the angle-adjustable foot plate



- 5 mm Allen key

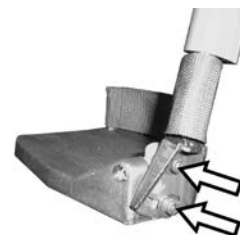

1. Use the Allen key to loosen both set screws on the foot plate.
2. Adjust to the desired angle.
3. Re-tighten the screws.

5.21.8 Adjusting the angle- and depth-adjustable foot plate



- 5 mm Allen key



1. Use the Allen key to loosen the set screw on the foot plate (1).
2. Adjust the foot plate to the desired angle or depth.
3. Re-tighten the screw.

5.22 Adjusting the width of side-mounted legrests



Tools:

- 13 mm wrench
-

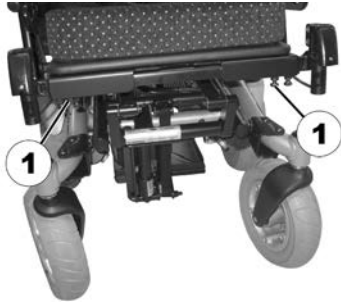

The screws that allow width adjustment of side-mounted legrests are located under the seat (1).

1. Loosen the screws using the wrench.
2. Adjust the legrest to the desired position.
3. Re-tighten the screws.

6 Usage

6.1 Before Driving for First Time

Before you take your first trip, you should familiarise yourself well with the operation of the mobility device and with all operating elements. Take your time to test all functions and driving modes.



If installed, make sure to properly adjust and use the posture belt each time you use the mobility device.

Sitting comfortably = Driving safely

Before each trip, make sure that:

- You are within easy reach of all operating controls.
- The battery charge is sufficient for the distance you intend to travel.
- The posture belt (if installed) is in perfect order.
- The rear mirror (if installed) is adjusted so you can look behind at all times without having to bend forward or shift your seating position.

6.2 Getting in and out of Mobility Device



– The armrest must be removed or swiveled up in order to get into or out of the mobility device from the side.

6.2.1 Removing armrests to get in

If you want to get out on the side where the remote is installed, you can disconnect the remote cable from the remote (depending on your version).



1. Remove remote cable from remote. Refer to 6.2.2 *Disconnecting Remote*, page 80.
2. Loosen clamping lever (1).
3. Remove side panel from holder.

6.2.2 Disconnecting Remote

1. Switch off remote.
- 2.

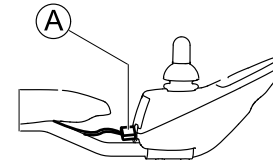

Fig. 6-1

Pull plug Ⓐ of remote cable to disconnect remote.

6.2.3 Information About Getting in and out



Fig. 6-2



WARNING!

Risk of serious injury or damage

Improper transfer techniques may cause serious injury or damage

- Before attempting transfers, consult a healthcare professional to determine proper transfer techniques for the user and type of wheelchair.
- Follow the instructions below.



If you do not have sufficient muscle strength, you should ask other persons for help. Use a sliding board, if possible.

Getting into Mobility Device:

1. Position your mobility device as close as possible to your seat. This might have to be done by an attendant.
2. Align casters parallel to drive wheels to improve stability during transfer.
3. Always switch your mobility device off.
4. Always engage both motor locks/clutches and free wheel hubs (if fitted) to prevent wheels from moving.

5. Depending on armrest type of your mobility device, detach armrest or swivel it up.
6. Now slide into mobility device.

Getting out of Mobility Device:

1. Position your mobility device as close as possible to your seat.
2. Align casters parallel to drive wheels to improve stability during transfer.
3. Always switch your mobility device off.
4. Always engage both motor locks/clutches and free wheel hubs (if fitted) to prevent wheels from moving.
5. Depending on armrest type of your mobility device, detach armrest or swivel it up.
6. Now slide onto your new seat.

6.3 Taking Obstacles

6.3.1 Maximum Obstacle Height

You can find information about maximum obstacle heights in the chapter entitled *11 Technical Data, page108*

6.3.2 Safety Information When Taking Obstacles



CAUTION!

Risk of tipping over

- Never approach obstacles at an angle but at 90 degrees as shown below.
- Approach obstacles followed by a gradient with caution. If unsure whether the gradient is too steep or not, move away from the obstacle and if possible try to find another location.
- Never approach obstacles on an uneven and/or loose ground.
- Never drive with too low tire pressure.
- Put your backrest into an upright position before ascending an obstacle.



CAUTION!

Risk of falling out of the mobility device and damage to the mobility device such as broken casters

- Never approach obstacles that are higher than the maximum climbable obstacle height.
- Never let the footrest/legrest touch the ground when descending an obstacle.
- If unsure whether taking an obstacle is possible or not, move away from the obstacle and if possible find another location.

6.3.3 Correct Way to Take Obstacles



The following instructions how to take obstacles also apply for attendants if the mobility device is fitted with an attendant control.

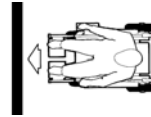

Fig. 6-3 Right



Fig. 6-4 Wrong

Ascending

1. Approach obstacle or curb slowly, head-on and at a right angle.
2. Depending on wheel drive type, stop in one of following positions:
 - a. In the case of centrally driven mobility devices: 5 - 10 cm before obstacle.
 - b. For all other drives: approx. 30 - 50 cm in front of obstacle.
3. Check position of front wheels. They must be in driving direction and at right angles to obstacle.
4. Approach slowly and keep at consistent speed until rear wheels have also passed over obstacle.

Ascending Obstacles With Curb Climber

1. Approach obstacle or curb slowly, head-on and at right angle.
2. Stop in following position: 30 – 50 cm in front of obstacle.
3. Check position of front wheels. They must be in driving direction and at right angles to obstacle.
4. Approach with full speed until curb climber makes contact with obstacle. Impetus will lift both front wheels over obstacle.
5. Keep at consistent speed until rear wheels have also passed over obstacle.

Descending

The approach to descend an obstacle is the same as to ascend it with the difference that you need not to stop before descending.

1. Descend obstacle with medium speed.



When descending an obstacle too slowly it could happen that the antitippers get stuck and lift the drive wheels off the ground. Driving the mobility device is then no longer possible.

6.4 Driving up and down Gradients

For information concerning the maximum safe slope, refer to *11 Technical Data, page 108*



CAUTION!

Risk of tipping over

- Only ever drive downhill at a maximum of 2/3 of the top speed. Avoid sudden changes of direction or abrupt braking when driving on slopes.
- Always return the backrest of your seat or the seat tilt (if adjustable seat tilt is available) to an upright position before ascending slopes. We recommend that you position the seat backrest or the seat tilt slightly to the rear before descending slopes.
- Always lower the lifter (if fitted) to its lowest position before ascending or descending a slope.
- Never attempt to ascend or descend a slope on slippery surfaces or where there is a risk of skidding (such as wet pavement, ice etc).
- Avoid trying to get out of the mobility device on an incline or a gradient.
- Always drive straight in the direction the road or path you are on goes, rather than attempting to zigzag.
- Never attempt to turn around on an incline or a slope.



CAUTION!

Braking distance is much longer on a downhill slope than on even terrain

- Never drive down a slope that exceeds the rated slope (refer to *11 Technical Data, page 108*).

6.5 Parking and Stationary

When parking your mobility device or if your mobility device is stationary for a prolonged period:

1. Switch the mobility device's power system off (ON-/OFF key).
2. Activate your anti-theft lock, if existing.

6.6 Use on Public Roads

If you wish to use your mobility device on public roads and lighting is required by national legislation, then your mobility device needs to be fitted with an appropriate lighting system.

Contact your Invacare provider if you have any questions.

6.7 Pushing the mobility device in freewheel mode

The motors of the mobility device are equipped with automatic brakes, preventing that the mobility device starts rolling out of control when the remote is switched off. When pushing the mobility device manually whilst freewheeling, the magnetic brakes must be disengaged.

-  Pushing the mobility device by hand may require more physical force than expected (more than 100 N). The necessary force nevertheless complies with the requirements of ISO 7176-14.



The intended use of the freewheel mode is to maneuver the mobility device over short distances. The push handles or push bars support this function, but be aware that there might be some impairment between the feet of the assistant and the rear part of the mobility device.

6.7.1 Disengaging motors (conventional motors)



CAUTION!

Risk of injury from hot motor surfaces

- Avoid touching the motor surfaces when engaging or disengaging.



CAUTION!

Risk of the mobility device running away

- When the motors are disengaged (for push operation whilst freewheeling), the electromagnetic motor brakes are deactivated. When the mobility device is parked, the levers for engaging and disengaging the motors must without fail be locked firmly into the "DRIVE" position (electromagnetic motor brakes activated).



The motors may only be disengaged by an attendant, not by the user.

This ensures that the motors are only disengaged if an attendant is available to secure the wheelchair and prevent unintended rolling.

Each motor is fitted with an engaging lever which is used to engage or disengage the motor.

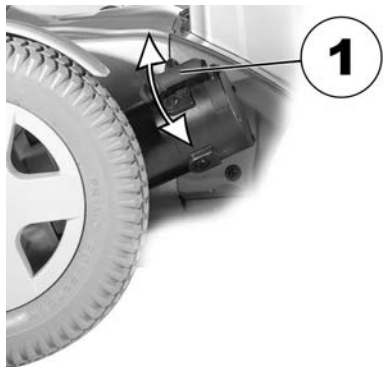

Disengaging the motor:

1. Switch off remote.
2. Pull the engaging lever (1) upwards.
The motor is disengaged.

Engaging the motor:

1. Push the engaging lever down (1).
The motor is engaged. Please note that both motors must always be engaged before driving!

7 Controls System

7.1 Controls Protection System

The wheelchair controls system is fitted with an overload protection.

If the drive is severely overloaded over a long period of time (for example, when driving up a steep hill) and especially when the ambient temperature is high, the controls system could overheat. In this case, the wheelchair performance is gradually reduced until it comes to a halt. The status display shows a corresponding error code (refer to the user manual for your remote). By switching the power supply off and back on again, the error code is cleared and the controls system is switched back on. It can however take up to five minutes until the controls system has cooled down enough for the drive to restore full performance again.

If the drive is stalled by an insurmountable obstacle, for example, a curb or similar which is too high, and the driver attempts driving for more than 20 seconds against this obstacle, the controls system automatically switches off to prevent the motors from being damaged. The status display shows a corresponding error code (refer to the user manual of your remote). By switching off and back on again, the error code is cleared and the controls system is switched back on.



A defective main fuse may be replaced only after checking the entire controls system. A specialised Invacare provider must perform the replacement. You can find information on the fuse type in *11 Technical Data, page 108*

7.2 Batteries

Power is supplied by two 12 V batteries. The batteries are maintenance-free and only need regular charging.

In the following, you find information on how to charge, handle, transport, store, maintain, and use batteries.

7.2.1 General Information on Charging

New batteries should always be fully charged once before their first use. New batteries will be at their full capacity after having run through approx. 10 - 20 charging cycles (break-in period). This break-in period is necessary to fully activate the battery for maximum performance and longevity. Thus, range and running time of your mobility device could initially increase with use.

Gel/AGM lead acid batteries do not have a memory effect as NiCd batteries.

7.2.2 General Instructions on Charging

Follow the instructions listed below to ensure safe use and longevity of the batteries:

- Charge 18 hours prior to initial usage.
- We recommend charging the batteries daily after every discharge even after partly discharge, as well as each night over night. Depending on the level of discharge, it can take up to 12 hours until the batteries are fully charged again.
- When the battery indicator reached the red LED range, charge the batteries for 16 hours minimum, neglecting the charge complete display!
- Try to provide a 24 hour charge once a week to make sure that both batteries are fully charged.

- Do not cycle your batteries at a low state of charge without regularly recharging them fully.
- Do not charge your batteries under extreme temperatures. High temperatures above 30 °C are not recommended for charging as well as low temperatures below 10 °C.
- Use only charging devices in Class 2. This class of chargers may be left unattended during charging. All charging devices which are supplied by Invacare comply with these requirements.
- You cannot overcharge the batteries when using the charger supplied with your mobility device, or a charger that has been approved by Invacare.
- Protect your charger from sources of heat such as heaters and direct sunlight. If the battery charger overheats, charging current will be reduced and the charging process delayed.

7.2.3 Charging Batteries

Refer to the user manuals for your remote and battery charger for the position of the charging socket and further information about charging the batteries.



WARNING!

Risk of explosion and destruction of batteries if the wrong battery charger is used

- Only ever use the battery charger supplied with your mobility device, or a charger that has been approved by Invacare.



WARNING!

Risk of electric shock and damage to the battery charger if it gets wet

- Protect the battery charger from water.
- Always charge in a dry environment.



WARNING!

Risk of short circuit and electric shock if the battery charger has been damaged

- Do not use the battery charger if it has been dropped or damaged.



WARNING!

Risk of electric shock and damage to the batteries

- NEVER attempt to recharge the batteries by attaching cables directly to the battery terminals.



WARNING!

Risk of fire and electric shock if a damaged extension cable is used

- Only ever use an extension cable if it is absolutely necessary. In case you must use one, make sure it is in good condition.

**WARNING!****Risk of injury if using the mobility device during charging**

- DO NOT attempt to recharge the batteries and operate the mobility device at the same time.
- DO NOT sit in the mobility device while charging the batteries.

1. Switch off mobility device.
2. Connect battery charger to charger socket.
3. Connect battery charger to power supply.

7.2.4 Disconnecting Mobility Device After Charging

1. Once charging is complete, first disconnect battery charger from power supply, then disconnect plug from remote.

7.2.5 Storage and Maintenance

Follow the instructions listed below to ensure safe use and longevity of the batteries:

- Always store the batteries fully charged.
- Do not leave the batteries in a low state of charge for an extended length of time. Charge a discharged battery as soon as possible.
- In case your mobility device is not used for a longer period of time (that is more than two weeks), the batteries must be charged at least once a month to maintain a full charge and always be charged before use.
- Avoid hot and cold extremes when storing. We recommend to store batteries at a temperature of 15 °C.

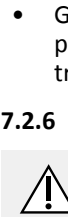
**CAUTION!****Risk of damaging the batteries.**

- Avoid ultra-deep discharges and never drain your batteries completely.

7.2.6 Instructions on Using Batteries

- Pay attention to the Battery Charge Indicator! Charge the batteries when the Battery Charge Indicator shows that battery charge is low.
How fast the batteries discharge depends on many circumstances, such as ambient temperature, condition of the surface of the road, tire pressure, weight of the driver, way of driving and utilisation of lighting, if fitted.
- Try to charge the batteries always before you reach the red LED range.
The last 3 LED (two red and one orange) mean a remaining capacity of about 15 %.
- Driving with flashing red LED's means an extreme stress for the battery and should be avoided under normal circumstances.
- When only one red LED is flashing, the Battery Safe feature is enabled. From this time, speed and acceleration is reduced drastically. It will allow you to move the mobility device slowly out of a dangerous situation before the electronic finally cuts off. This is deep discharging and should be avoided.

- Be aware that for temperatures below 20 °C, the nominal battery capacity starts to decline. For example, at -10 °C the capacity is reduced to about 50 % of the nominal battery capacity.
- To avoid damaging the batteries, never allow them to be fully discharged. Do not drive on heavily discharged batteries if it is not absolutely necessary, as this will strain the batteries unduly and shorten their life expectancy.
- The earlier you recharge the batteries, the longer they live.
- The depth of discharge affects the cycle life. The harder a battery has to work, the shorter is its life expectancy. Examples:
 - One deep discharge stresses the same as 6 normal cycles (green /orange display off).
 - The battery life is about 300 cycles at 80 % discharge (first 7 LED off), or about 3000 cycles at 10 % discharge (one LED off).



The number of LED can vary depending on the remote type.

- Under normal operation, once a month the battery should be discharged until all green and orange LED are off. This should be done within one day. A 16 hour charge afterwards is necessary as reconditioning.

7.2.7 Transporting Batteries

The batteries supplied with your mobility device are not hazardous goods. This classification is based on the German GGVS Hazardous Goods Road Transport Ordinances, and the IATA/DGR Hazardous Goods Rail Transport / Air Transport Ordinances. Batteries may be transported without

restrictions, whether by road, rail or by air. Individual transport companies have, however, guidelines which can possibly restrict or forbid certain transport procedures. Please ask the transport company regarding each individual case.

7.2.8 General Instructions on Handling Batteries

- Never mix and match different battery manufactures or technologies, or use batteries that do not have similar date codes.
- Never mix gel with AGM batteries.
- The batteries reach their end of life when the drive range is significantly smaller than usual. Contact your provider or service technician for details.
- Always have your batteries installed by a properly trained mobility device technician or a person with adequate knowledge. They have the necessary training and tools to do the job safely and correctly.

7.2.9 Handling Damaged Batteries Correctly



CAUTION!

Corrosion and burns from acid leakage if batteries are damaged

- Remove clothes that have been soiled by acid immediately.

After contact with skin:

- Immediately wash affected area with lots of water.

After contact with eyes:

- Immediately rinse eyes under running water for several minutes; consult a physician.

- Always wear safety goggles and appropriate safety clothing when handling damaged batteries.
- Place damaged batteries in an acid-resistant receptacle immediately after removing them.
- Only ever transport damaged batteries in an appropriate acid-resistant receptacle.
- Wash all objects that have come into contact with acid with lots of water.

Disposing of Dead or Damaged Batteries Correctly

Dead or damaged batteries can be given back to your provider or directly to Invacare.

7.2.10 Use the correct batteries



CAUTION!

Risk of injury and risk of damage to the batteries if incorrect batteries are used

- Only use batteries that have a pole configuration like that described below.

For the FDX you may only use batteries that have the positive pole on the left and the negative one on the right. The poles must have an internal thread. See the following illustration:

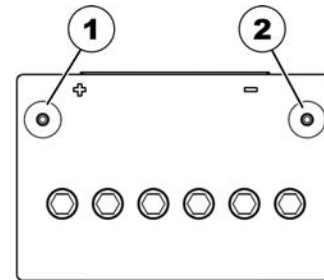

Fig. 7-1 Correct battery

(1) PLUS pole (+)

(2) NEGATIVE pole (-)

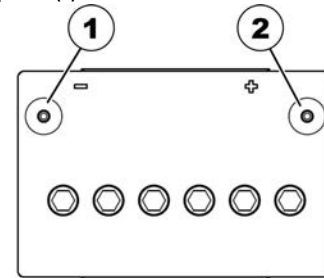

Fig. 7-2 Wrong battery

(1) NEGATIVE pole (-)

(2) PLUS pole (+)



NOTE

- Use only batteries of the same type.

8 Transport

8.1 Transport — General information



CAUTION!

Risk of injury or material damage if a mobility device which is fitted with a tray is transported in a vehicle

- If a tray is fitted, always remove it before transporting the mobility device.



8.2 Transferring Mobility Device to Vehicle



WARNING!

Mobility device is at risk of tipping over if transferred to a vehicle while user is still seated in mobility device

- Transfer mobility device without user whenever possible.
- If mobility device with user must be transferred to vehicle using a ramp, ensure that ramp does not exceed rated slope.
- If mobility device must be transferred to vehicle using a ramp that does exceed rated slope, a winch must then be used. An attendant can then safely monitor and assist transfer process.
- Alternatively, a platform lift may be used.
- Ensure that total weight of mobility device including user does not exceed maximum permitted total weight for ramp or platform lift.
- Mobility device should always be transferred to vehicle with backrest in upright position, seat lifter lowered and tilt in upright position (refer to *6.4 Driving up and down Gradients, page 83*).

**WARNING!****Risk of injury and damage to mobility device and vehicle**

Risk of tipping over or uncontrolled movements of mobility device if transferred to vehicle using a ramp that exceeds rated slope.

- Transfer mobility device to vehicle without user.
- An attendant must assist transfer process.
- Ensure that all carer fully understand manual of ramp and winch.
- Ensure that winch is suitable for your mobility device.
- Use only suitable tie-down points. Do not use removable or movable components of mobility device as tie-down points.

**WARNING!****Risk of injury and damage to mobility device**

If mobility device must be transferred to vehicle via a lift, when remote is turned on, there is a risk that device may act erratically and fall off lift.

- Before transferring mobility device via lift, turn off product and disconnect either bus cable from remote or batteries from system.

1. Drive or push your mobility device into transport vehicle using suitable ramp.

8.3 Use of Mobility Device as Seat in Vehicle



The following section does not apply to models or configurations which may not be used as a vehicle seat. These are identified by the following label on the mobility device:

**WARNING!****Risk Of Injury Or Damage**

Our wheelchairs are successful tested for payloads up to 136 kg. If it is loaded with more than 136 kg, it might be unsafe in the event of a crash.

- Do not use the wheelchair as a seat in a vehicle if the payload is higher than 136 kg.

**WARNING!****Risk of death or serious injury**

If a mobility device is secured using a 4-point tie-down system available from a third party supplier and the curb weight of the mobility device exceeds the maximum weight for the system, death or serious injury to the user and potential nearby occupant.

- The actual weight of this mobility device can exceed 140 kg. Make sure to use a 4-point tie-down system checked and approved in accordance with ISO 10542 and certified for the actual weight of the mobility device. Consult the tie-down system manufacturer's documentation.
- If compatible, use the Docking Station system (available separately) as an alternative way to safely use this wheelchair as a vehicle seat. Contact Invacare for more details.

**WARNING!****Risk of injury**

Safety restraint devices must only be used when the wheelchair user's weight is 22 kg or more.

- When the user weight is lower than 22 kg, do not use the wheelchair as a seat in a vehicle.

**CAUTION!****There is a risk of injury if the mobility device is not properly secured during use as a vehicle seat.**

- If possible, the user should always leave the mobility device to use a vehicle seat and the safety belts provided with the vehicle.
- The mobility device should always be anchored facing in the transport vehicle's intended direction of travel.
- The mobility device must always be secured in accordance with the mobility device and anchoring system manufacturers' user manual.
- Always remove and secure any accessory parts fixed to the mobility device such as chin controls or tables.
- If your mobility device is fitted with an angle adjustable backrest, then it must be placed in an upright position.
- Fully lower elevated legrests, if fitted.
- Fully lower the seat lifter, if fitted.

**CAUTION!****Risk of injury exists if a mobility device that is not fitted with leak-proof batteries is transported in a vehicle.**

- Only ever use leak-proof batteries.

**CAUTION!**

Risk of injury or damage to the mobility device or to the transporting vehicle, if the legrests are in a raised position while the mobility device is used as a vehicle seat.

- Always completely lower height-adjustable legrests, if fitted.



Risk of damage to the headrest when using a Modulite seat and securing the mobility device with the Docking Station system

If you secure the mobility device with the Docking Station system and use a Modulite seat and the headrest is not set to the lowest possible position, the headrest might come loose during an accident.

- Always set the height of the headrest to the lowest possible position. Refer to *5.10.2 Adjusting Height of Rea Headrest or Neckrest, page 48*.
- Next, the headrest must be adjusted to the user's ear height. Refer to *5.10.1 Adjusting Position of Rea Headrest or Neckrest, page 48*.



In order to use a mobility device as a motor vehicle seat, it needs to be fitted with attachment points to enable anchoring in the motor vehicle. These accessories may be included in the standard scope of mobility device order and delivery in some countries (UK for example), but may also be obtained from Invacare as an option in other countries.

This mobility device complies with the requirements of ISO 7176-19 and may be used as a vehicle seat in connection with an anchoring system that has been checked and approved in accordance with ISO 10542. The transporting vehicle must be professionally converted to anchor the mobility device. Contact your vehicle's manufacturer for more information.

The mobility device has undergone a crash test in which it was anchored in the transporting vehicle's direction of travel. Other configurations were not tested. The crash test dummy was secured using pelvic and upper body safety belts. Both types of safety belt should be used in order to minimize the risk of injuries to head or upper body.

It is imperative that the mobility device is inspected by an authorized provider before being used again after being involved in a crash. Alterations to the mobility device anchoring points may not be carried out without the manufacturer's permission.

8.3.1 How the mobility device is anchored in a vehicle for use as a vehicle seat

The mobility device is fitted with four tie-down points. Snap hooks or belt loops can be used for fixation. If the wheelchair can be used as a vehicle seat, these tie-down points are labelled with the symbol shown on the right.



8.3.2 How the user is secured within the mobility device



CAUTION!

Risk of injury if the user is not properly secured within the mobility device

- Even if the mobility device is fitted with a posture belt, this is no substitute for a proper safety belt which complies with ISO 10542 in the transport vehicle. Always use the safety belt installed in the transport vehicle.
- Safety belts must be in contact with the user's body. They must not be held at a distance from the user's body using parts of the mobility device such as armrests or wheels.
- Safety belts must be pulled as tightly as possible without causing the user discomfort.
- Safety belts must not be positioned while twisted.
- Ensure that the third seat belt anchorage point is not fixed directly to the vehicle floor, but to one of the vehicle uprights.



Fig. 8-1 Front



Fig. 8-2 Rear

1. Secure the mobility device at the front (1) and at the rear (2) with the tie-down system belts.
2. Secure the mobility device by tensioning the belts in accordance with the tie-down system manufacturer's user manual.



CAUTION!

Risk of injury during use of the mobility device as a vehicle seat if a headrest is wrongly adjusted or not installed

This can cause the neck to be hyperextended during collisions.

- A headrest must be installed. The headrest optionally supplied for this mobility device by Invacare is perfectly suitable for use during transport.
- The headrest must be adjusted to the user's ear height.

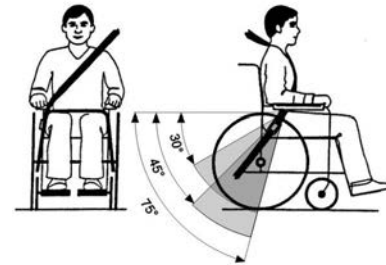

The pelvic belt should be positioned in the area between the user's pelvis and thighs so that it is unobstructed and not too loose. The ideal angle of the pelvic belt to the horizontal is between 45° and 75°. The maximum permissible angle is between 30° and 75°. The angle should never be less than 30°!

Seat belts may not be held at a distance from the user's body using parts of the mobility device such as armrests or wheels.

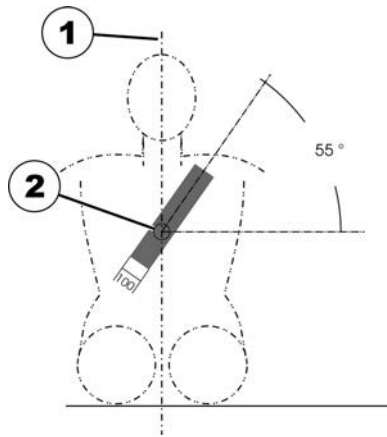

The safety belt installed in the transporting vehicle should be applied as shown in the illustration above.

- 1) Center line of the body
- 2) Center of the sternum

8.4 Transporting the mobility device without occupant



CAUTION!

Risk of injury

– If you are unable to fasten your mobility device securely in a transport vehicle, Invacare recommends that you do not transport it.

Your mobility device may be transported without restrictions, whether by road, rail or by air. Individual transport companies have, however, guidelines which can possibly

restrict or forbid certain transport procedures. Please ask the transport company regarding each individual case.

- Before transporting your mobility device, make sure the motors are engaged and that the remote is switched off. Invacare strongly recommends that you additionally disconnect or remove the batteries. Refer to Removing the batteries.
- Invacare strongly recommends securing the mobility device to the floor of the transporting vehicle.

8.4.1 Removing the front shroud

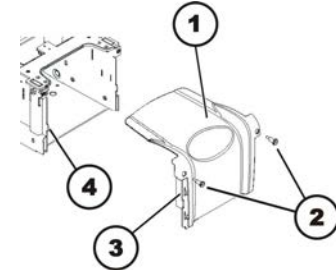

Removing the front shroud:

1. Remove legrest hangers.
2. Loosen and remove two thumb screws (2).
3. Slide front shroud (1) up a little and pull shroud forward to remove it.

Replacing the front shroud:

1. Replace parts in reverse order.
2. Replace plastic shroud in such a way that recesses on side (3) and lower hooks of shroud hook into chassis (4).
3. Tighten two thumb screws (2) by hand.

8.4.2 Removing the rear shroud

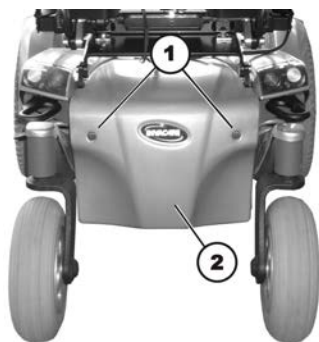

Removing the rear shroud:

1. Loosen and remove two thumb screws (1).
2. Remove rear shroud (2).

Replacing the rear shroud:

1. Replace parts in reverse order.
2. Tighten two thumb screws by hand.

8.4.3 Removing/Installing the batteries



WARNING!

Fire and burn hazard due to short circuit at battery poles

- DO NOT short-circuit the battery poles with a tool or metal parts of the wheelchair.
- Make sure that the battery pole caps are attached at all times when you are not working on the battery poles.



CAUTION!

Risk of crushing

The batteries are very heavy. There is a risk of hand injury.

- Be aware that the batteries are very heavy.
- Handle the batteries with care.



- Phillips screwdriver, size 2
- Wire cutters
- Cable ties

Removing the batteries:

1. Remove the legrest hangers.
2. Remove the front shroud as described in chapter 8.4.1 *Removing the front shroud, page 97*.
- 3.

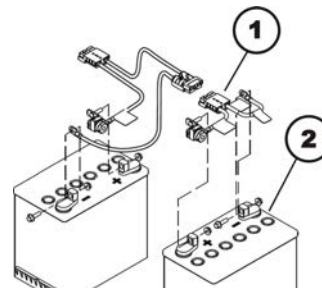

Disconnect the battery connector (1) from the front battery (2).

4. Remove the rear shroud as described in chapter 8.4.2 *Removing the rear shroud, page 98*.

5.

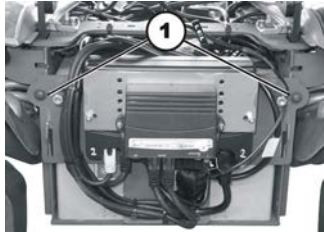

Note the position of the cabling and the slots for the different plugs carefully. Label the connectors and sockets or take a photograph using a digital camera.

6. If required, remove the cable ties that secure the cable bundles on both sides of the electronic modules to the chassis.
7. Place the cable bundles out of the way of the screws (1).
8. Loosen and remove the two screws and washers using a Phillips screwdriver.
- 9.

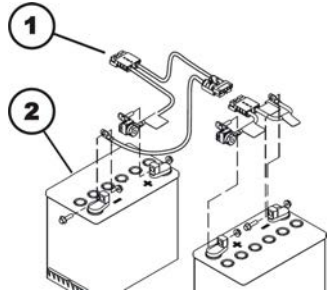

Disconnect the battery connector (1) from the rear battery (2).

10. Disconnect the battery cable from the electronic module.

11. Lift the electronic module rack and remove it. Place the rack underneath the wheelchair to the rear.
12. Pull the two batteries backwards out of the chassis and remove them. Remember that the batteries are very heavy

Fitting the batteries:

1. Fit the batteries in the reverse order.
2. Ensure that the connectors and sockets in the battery compartment are fitted correctly. There is a polarity diagram in the battery compartment shroud.

8.5 Dahl Docking System





To retrofit a mobility device with a Dahl Docking system, it is imperative, that the mobility device is equipped with the correct adapter plate. This adapter plate must be threaded to fix the lock plate of the Dahl Docking system underneath the mobility device.

The maximum payload with the Dahl Docking system is 136 kg.

The maximum weight of the mobility device must not exceed 200 kg.

For more information about retrofitting, contact your provider.

 The description of how to install the Dahl Docking system to maintain the CE-marking of the product is contained in the service manual of this mobility device. The service manual can be ordered from Invacare.

 **Positioning the occupant restraint when using it with the Dahl Docking system only**

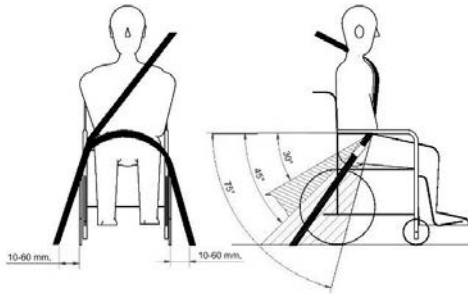

When using mobility device with a Dahl Docking system, the floor anchorage points for the occupant restraint system should be located 10 – 60 mm outside wheels on each side. The pelvic belt must be worn low across the front of the pelvis so that the angle of the pelvic belt is within the preferred zone of 30° to 45° as shown. A steeper angle within the optional zone, 45° to 75° is desirable, but never exceeding 75°.

Components of Dahl Docking System

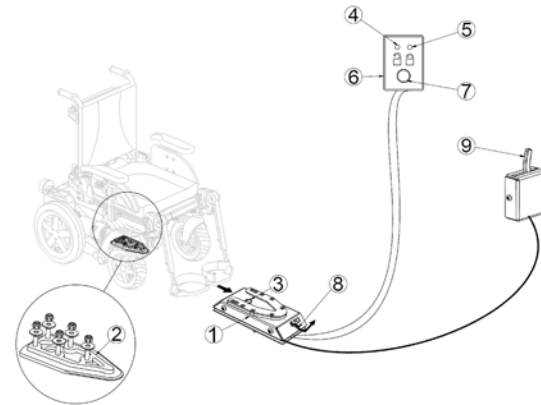

Fig. 8-3

- (1) Dahl Docking station
- (2) Lock plate and 8 mm spacer
- (3) Locking pin
- (4) Red LED
- (5) Green LED
- (6) Control panel
- (7) Release button
- (8) Manual emergency release lever
- (9) Manual operating lever (optional)

Locking in Dahl Docking Station



WARNING!

Risk of Death, Serious Injury or Damage

If the vehicle is moved while the mobility device is not correctly secured in the Dahl Docking station, death, serious injury or damage may occur.

- Do not move the vehicle while the mobility device is maneuvered into position in the Dahl Docking station.
 - Do not move the vehicle if mobility device and user are not correctly secured.
 - Do not move the vehicle if the warning tone sounds and/or if the red LED in the control panel flashes or is lit.
1. Maneuver mobility device slowly and in straight direction over Dahl Docking station (1). Lock plate (2) underneath mobility device helps to guide mobility device into Dahl Docking station.
 2. If lock plate is fully engaged in Dahl Docking station, locking pin (3) automatically secures lock plate.
 3. Dahl Docking station is equipped with control switch that indicates if lock plate is correctly secured in Dahl Docking station.
As soon as lock plate comes in contact with locking pin, warning tone sounds (high-pitched howl) and red LED in control panel (6) lights up until lock plate is either fully engaged or mobility device is removed from Dahl Docking station.

4. When mobility device is properly secured, warning tone ceases, red LED goes out and green LED lights up.
5. Buckle up with seat belt of vehicle.



Always check before moving the vehicle if lock plate is properly engaged in the Dahl Docking station by trying to reverse the mobility device out of the Dahl Docking station. It must not be possible to reverse out of the Dahl Docking station without pressing the red release button (7) in the control panel.

Unlocking from Dahl Docking Station

1. Stop and prevent vehicle from moving.
2. Remove seat belt.
3. Move mobility device forward to release pressure on locking pin.
4. Press red release button (7) in control panel. Locking pin is released for approx. five seconds, after which locking pin is automatically locked again.
5. Move mobility device away from Dahl Docking station within five-second period.
Do not attempt to reverse mobility device until red LED, which indicates unlock position, lights up.



Attempting to reverse the mobility device before the red LED lights up, results in blocking the Dahl Docking station's locking mechanism, which makes it impossible to reverse. If this happens, repeat unlocking procedure.

Manual Unlocking in Case of Electrical Failure



The following instructions require the help of an attendant.

1. Move mobility device forward to release pressure on locking pin.
2. Push manual emergency release lever (8) to one side and hold it there, while mobility device moves away.
3. A cable-activated manual operating lever (9) can also be fitted (accessory).
Push lever to one side and hold it there, while mobility device moves away.



If the manual unlocking procedure fails, an emergency release tool made from red plastic comes with each Dahl Docking station.

1. Move mobility device forward to release pressure on locking pin.
- 2.



Fig. 8-4

Place emergency release tool in gap between locking plate and Dahl Docking station.

- 3.



Fig. 8-5

Push emergency release tool and mobility device forward until locking pin has been forced down.

4. Move mobility device away from Dahl Docking station.

9 Maintenance

9.1 Maintenance Introduction

The term “Maintenance” means any task performed to ensure that a medical device is in good working order and ready for use as intended. Maintenance encompasses different areas, such as everyday care and cleaning, inspection checks, repair tasks and refurbishment.



Have your vehicle checked once a year by an authorised Invacare provider in order to maintain its driving safety and roadworthiness.

9.2 Cleaning Mobility Device

When cleaning the mobility device, pay attention to the following points:

- Only use a damp cloth and gentle detergent.
- Do not use any abrasive or scouring agents.
- Do not subject the electronic components to any direct contact with water.

9.3.1 Before Each Use of Mobility Device

Item	Inspection Check	If Inspection is not Passed
Screwed connections	Check all connections, such as backrests and wheels, for tight fit.	Contact your provider.
Signal horn	Check for correct function.	Contact your provider.

- Do not use any high-pressure cleaning devices.

Disinfection

Spray or wipe disinfection using a tested and recognised product is permitted. A list of the current permitted disinfectants is available from the Robert Koch Institute at <http://www.rki.de>.

9.3 Inspection Checks

The following tables list inspection checks that should be performed by the user and their intervals. If the mobility device fails to pass one of the inspection checks, refer to the chapter indicated or contact your authorised Invacare provider. A more comprehensive list of inspection checks and instructions for maintenance work can be found in the service manual for this device, which can be obtained from Invacare. That manual, however, is intended to be used by trained and authorised service technicians, and describes tasks which are not intended to be performed by the user.

Item	Inspection Check	If Inspection is not Passed
Lighting system	Check that all lights, such as turn indicators, head lamps and tail lights, are functioning correctly.	Contact your provider.
Batteries	Make sure batteries are charged. Refer to user manual provided with your remote for a description of Battery Charge Indicator.	Charge the batteries (refer to <i>7.2.3 Charging Batteries, page 87</i>).

9.3.2 Weekly

Item	Inspection check	If inspection is not passed
Armrests /side parts	Check that armrests are firmly attached in their holders and do not wobble.	Tighten the screw or clamping lever that holds the armrest (see chapter <i>5 Setup, page 27</i>). Contact your provider.
Tires (pneumatic)	Check that the tires are undamaged.	Contact your provider.
	Check that the tires are inflated to the correct pressure.	Inflate the tire to the correct pressure (see chapter <i>11 Technical Data, page 108</i>). Contact your provider to have it repaired.
Tires (puncture-proof)	Check that the tires are undamaged.	Contact your provider.

9.3.3 Monthly

Item	Inspection Check	If Inspection is not Passed
All upholstered parts	Check for damage and wear.	Contact your provider.
Removable legrests	Check whether legrests can be fixed securely and whether loosening mechanism is properly operable.	Contact your provider.
	Check that all adjustment options function properly.	Contact your provider.

Item	Inspection Check	If Inspection is not Passed
Castors	Check that castors rotate and swivel freely.	Contact your provider.
Drive wheels	Check that drive wheels rotate without wobbling. It is easiest to have someone stand behind mobility device and observe drive wheels as you drive away from them to do this.	Contact your provider.
Electronics and connectors	Check all cables for damage and all connecting plugs for snug fit.	Contact your provider.

9.4 Wheels and Tyres

Dealing With Wheel Damages

In case of having a damaged wheel, contact your provider. Because of safety reasons do not have the wheel repaired by yourself or by not authorised persons.

Dealing With Pneumatic Tyres



Risk of damage to tyre and rim

Never drive with too low tyre pressure, this could result in damage to tyre.

If tyre pressure is exceeded rim could be damaged.

– Inflate tyres to recommended pressure.



Use tyre gauge to check pressure.

Check weekly that the tyres are inflated to the correct pressure, see chapter 9.3 *Inspection Checks, page 103*

For recommended tyre pressure see inscription on tyre/rim or contact Invacare. Compare table below for conversion.

psi	bar
22	1.5
23	1.6
25	1.7
26	1.8
28	1.9
29	2.0
30	2.1
32	2.2
33	2.3
35	2.4
36	2.5
38	2.6
39	2.7

psi	bar
41	2.8
44	3.0

9.5 Short-Term Storage

In case a serious fault is detected, a number of safety mechanisms are built into your mobility device and will protect it. The power module prevents your mobility device from driving.

When the mobility device is in such a condition and while waiting for repair:

1. Switch off power.
2. Disconnect the batteries.
Depending on the mobility device model, you can either remove the battery packs or disconnect the batteries from the power module. Refer to the corresponding chapter about disconnecting the batteries.
3. Contact your provider.

9.6 Long-Term Storage

In case your mobility device is not used for a longer period of time, you need to prepare it for storage to ensure a longer life for your mobility device and batteries.

Storing Mobility Device and Batteries

- We recommend to store the mobility device at a temperature of 15 °C, avoid hot and cold extremes when storing to ensure a long service life of the product and batteries.

- The components are tested and approved for greater temperature ranges as detailed below:
 - Allowable temperature range to store the mobility device is -40° up to 65 °C.
 - Allowable temperature range to store batteries is -25° up to 65 °C.
- Even not being used, batteries discharge themselves. Best practice is to disconnect the battery supply from the power module if storing the mobility device longer than two weeks. Depending on the mobility device model, you can either remove the battery packs or disconnect the batteries from the power module. Refer to the corresponding chapter about disconnecting the batteries. If in doubt which cable to disconnect, contact your provider.
- Batteries should always be fully charged before storing.
- If storing the mobility device longer than four weeks, check the batteries once a month and recharge as needed (before gauge reads half full) to avoid damage.
- Store in a dry, well-ventilated environment protected from outer influences.
- Slightly overinflate pneumatic tyres.
- Position the mobility device on flooring that is not discoloured by contact with tyre rubber.

Preparing Mobility Device for Use

- Re-connect the battery supply to the power module.
- The batteries must be charged before use.
- Have the mobility device checked by an authorised Invacare provider.

10 After Use

10.1 Reconditioning

This product is suitable for reuse. To recondition the product for a new user, carry out the following actions:

- Inspection according to service plan. See service manual, available from Invacare.
- Cleaning and disinfection. Refer to *9 Maintenance, page 103*
- Adaptation to the new user. Refer to *5 Setup, page 27*.

Make sure that the user manual is handed over with the product.

If any damage or malfunction is detected, do not reuse the product.

10.2 Disposal

- The equipment wrapping is potentially recyclable.
- The metal parts are used for scrap metal recycling.
- The plastic parts are used for plastic recycling.
- Electric components and printed circuit boards are disposed of as electronic scrap.
- Exhausted or damaged batteries can be returned to your medical equipment supplier or Invacare.
- Disposal must be carried out in accordance with the respective national legal provisions.
- Ask your city or district council for details of the local waste management companies.

11 Technical Data

11.1 Technical specifications

The technical information provided hereafter applies to a standard configuration or represents maximum achievable values. These can change if accessories are added. The precise changes to these values are detailed in the sections for the respective accessories.



Note that in some cases the measured values may vary up to ± 10 mm.

Permissible operating and storage conditions	
Temperature range for operation according to ISO 7176-9:	<ul style="list-style-type: none"> -25° ... +50 °C
Recommended storage temperature:	<ul style="list-style-type: none"> 15 °C
Temperature range for storage according to ISO 7176-9:	<ul style="list-style-type: none"> -25° ... +65 °C with batteries -40° ... +65 °C without batteries
Electrical system	
Motors	<ul style="list-style-type: none"> 2 x 250 W (6 km/h) 2 x 340 W (10 km/h)
Batteries	<ul style="list-style-type: none"> 2 x 12 V/60 Ah (C20) leakproof/gel
Main fuse	<ul style="list-style-type: none"> 120 A
Degree of protection	IPX4 ¹

Charging device	
Output current	<ul style="list-style-type: none"> • 8 A ± 8 % • 10 A
Output voltage	<ul style="list-style-type: none"> • 24 V nominal (12 cells)

Drive wheel tires	
Tire type (6 km/h)	<ul style="list-style-type: none"> • 12½" x 2¼" puncture-proof
Tire type (10 km/h)	<ul style="list-style-type: none"> • 14" x 3.00" pneumatic, puncture protected or puncture-proof
Tire pressure	<p>The recommended maximum tire pressure in bar or kpa is marked on the side wall of the tire or the rim. If more than one value is listed, the lower one in the corresponding units applies.</p> <p>(Tolerance = -0.3 bar, 1 bar = 100 kpa)</p>

Caster tires	
Tire type	<ul style="list-style-type: none"> • 200 x 60 puncture-proof

Driving characteristics	
Speed	<ul style="list-style-type: none"> • 6 km/h • 10 km/h
Min. braking distance	<ul style="list-style-type: none"> • 1000 mm (6 km/h) • 2100 mm (10 km/h)
Rated slope ²	
without lifter	<ul style="list-style-type: none"> • 8° (14 %) according to manufacturer's specifications with 136 kg payload, 4° seat angle, 20° backrest angle

Driving characteristics	
with lifter	<ul style="list-style-type: none"> 6° (10.5 %) according to manufacturer's specifications with 136 kg payload, 4° seat angle, 20° backrest angle
Max. climbable obstacle height	<ul style="list-style-type: none"> 60 mm
Turning radius	<ul style="list-style-type: none"> 700 mm
Drive range ³	<ul style="list-style-type: none"> 32 km (26 km in accordance with ISO 7176-4)

Dimensions in accordance with ISO 7176-15	Seat type		
	Basic Standard	Standard	Easy Adapt
Total height	<ul style="list-style-type: none"> 970 - 1270 mm 		<ul style="list-style-type: none"> 1060 - 1360 mm
Max. total width (component with widest point in parentheses)	<ul style="list-style-type: none"> 680 mm (measured from outer edge of armrests at seat width 43) 	<ul style="list-style-type: none"> 770 mm (measured from outer edge of armrests at seat width 53) 	
Total length (incl. standard legrests)	<ul style="list-style-type: none"> 1250 mm 		
Total length (without standard legrests)	<ul style="list-style-type: none"> 1070 mm 		
Seat height ⁴ (without lifter)	<ul style="list-style-type: none"> 465/480 mm (4° manually settable seat angle) 470 mm (electrically settable seat angle) 		
Seat height ⁴ (with lifter)	<ul style="list-style-type: none"> 470 - 770 mm 		
Seat width (armrest adjustment range in brackets)	<ul style="list-style-type: none"> 430 mm (440 - 530 mm⁵) 	<ul style="list-style-type: none"> 380 mm (390 - 480 mm⁵) 430 mm (440 - 530 mm⁵) 480 mm (490 - 580 mm⁵) 530 mm (540 - 620 mm⁵) 	
Seat depth	<ul style="list-style-type: none"> 410/460/510 mm 	<ul style="list-style-type: none"> 380 - 430/430 - 480/480 - 530 mm 	

Dimensions in accordance with ISO 7176-15	Seat type		
	Basic Standard	Standard	Easy Adapt
Backrest height ⁴	<ul style="list-style-type: none"> • 480/540 mm 		<ul style="list-style-type: none"> • 550 mm
Backrest angle	<ul style="list-style-type: none"> • 80°, 90°, 97,5°, 105°, 112,5°, 120° (manual) • 90° ... 106° (electrical) 		<ul style="list-style-type: none"> • 90° ... 120°
Armrest height	<ul style="list-style-type: none"> • 290 - 360 mm 	<ul style="list-style-type: none"> • 250 - 340 mm • 290 - 380 mm 	
Seat angle, electrical adjustment	<ul style="list-style-type: none"> • 0° ... +28° 		
Seat angle, manual adjustment	<ul style="list-style-type: none"> • 0°, +4°, +8° 		

Dimensions in accordance with ISO 7176-15	Seat type	
	Recaro	Modulite
Total height	<ul style="list-style-type: none"> • 1290 - 1590 mm 	<ul style="list-style-type: none"> • 1050 (one piece seat plate) • 1100 - 1500 mm⁶ (telescopic seat frame, moving the backrest plate)
Max. total width (component with widest point in parentheses)	<ul style="list-style-type: none"> • 680 mm (measured from outer edge of armrests at seat width 48) 	<ul style="list-style-type: none"> • 770 mm (measured from outer edge of armrests at seat width 53)
Total length (incl. standard legrests)	<ul style="list-style-type: none"> • 1250 mm 	
Total length (without standard legrests)	<ul style="list-style-type: none"> • 1070 mm 	

Dimensions in accordance with ISO 7176-15	Seat type	
	Recaro	Modulite
Seat height ⁴ (without lifter)	<ul style="list-style-type: none"> • 465/480 mm (4° manually settable seat angle) • 470 mm (electrically settable seat angle) 	<ul style="list-style-type: none"> • 455/470 mm⁶
Seat height ⁴ (with lifter)	<ul style="list-style-type: none"> • 470 - 770 mm 	<ul style="list-style-type: none"> • 455 – 755 mm⁶ • 417 – 717 mm (FDX Low-Rider)
Seat width (armrest adjustment range in brackets)	<ul style="list-style-type: none"> • 480 mm (490 - 530 mm⁵) 	<ul style="list-style-type: none"> • 380 mm (390 - 480 mm⁵) • 430 mm (440 - 530 mm⁵) • 480 mm (490 - 580 mm⁵) • 530 mm (540 - 620 mm⁵)
Seat depth	<ul style="list-style-type: none"> • 460 - 510 mm 	<ul style="list-style-type: none"> • 410 – 510 mm
Backrest height ⁴	<ul style="list-style-type: none"> • 770 - 830 mm 	<ul style="list-style-type: none"> • 480/540 mm (sling back) • 560 - 660 mm (telescopic seat frame, moving the backrest)
Backrest angle	<ul style="list-style-type: none"> • 90° ... 135° 	<ul style="list-style-type: none"> • 90° ... 120°
Armrest height	<ul style="list-style-type: none"> • 290 - 380 mm 	<ul style="list-style-type: none"> • 245 - 310/295 - 360 mm (telescopic seat frame with T-armrest) • 275 – 340 mm/ 325 - 390 (one piece seat plate with T-armrest)
Seat angle, electrical adjustment	<ul style="list-style-type: none"> • 0° ... +28° 	<ul style="list-style-type: none"> • 0° ... +30° (with center of gravity shift)
Seat angle, manual adjustment	<ul style="list-style-type: none"> • 0°, +4°, +8° 	

Footrests and legrests		
Type	Length	Angle
Vari A	<ul style="list-style-type: none"> • 290 – 460 mm 	<ul style="list-style-type: none"> • 70° - 0°
Vari F	<ul style="list-style-type: none"> • 290 – 460 mm 	<ul style="list-style-type: none"> • 70° - 0°
ADE (electric)	<ul style="list-style-type: none"> • 290 – 460 mm 	<ul style="list-style-type: none"> • 75° - 0°
ADM (manual)	<ul style="list-style-type: none"> • 290 – 460 mm 	<ul style="list-style-type: none"> • 75° - 0°
Center-mounted (manual)	<ul style="list-style-type: none"> • 280 – 385 mm 	<ul style="list-style-type: none"> • 90° - 0°
Center-mounted powered LNX	<ul style="list-style-type: none"> • 340 – 490 mm 	<ul style="list-style-type: none"> • 97° - 7° • 90° - 0° • 83° - -7°

Weight⁷	
Curb weight	<ul style="list-style-type: none"> • min. 140 kg

Component weights	
Batteries	<ul style="list-style-type: none"> • approx. 22 kg per battery

Payload	
Max. payload	<ul style="list-style-type: none"> • 136 kg

Axle loads	
Max. front axle load	<ul style="list-style-type: none"> • 250 kg
Max. rear axle load	<ul style="list-style-type: none"> • 150 kg

- 1 IPX4 classification means that the electrical system is protected against spray water.
- 2 Static stability according to ISO 7176-1 = 9° (15.8 %)
Dynamic stability according to ISO 7176-2 = 6° (10.5 %)
- 3 Note: The drive range of a mobility device is strongly influenced by external factors, such as the speed setting of the wheelchair, the charging state of the batteries, surrounding temperature, local topography, road surface characteristics, tire pressure, weight of user, drive style and use of batteries for lighting, servos etc.
The specified values are theoretical maximum achievable values measured according to ISO 7176-4.
- 4 Measured without seat cushion
- 5 Width adjustable for side panel adjustment
- 6 Telescopic seat frame with sling seat + 30 mm
- 7 The actual curb weight depends on the fittings your mobility device has been supplied with. Every Invacare mobility device is weighed when leaving the works. Refer to the nameplate for the curb weight (including batteries) measured.

12 Service

12.1 Inspections Performed

It is confirmed by stamp and signature that all jobs listed in the inspection schedule of the service and repair instructions have been properly performed. The list of the inspection jobs to be performed can be found in the service manual which is available through Invacare.

Delivery Inspection	1st Annual Inspection
Stamp of authorised provider / Date / Signature	Stamp of authorised provider / Date / Signature
2nd Annual Inspection	3rd Annual Inspection

Stamp of authorised provider / Date / Signature	Stamp of authorised provider / Date / Signature
4th Annual Inspection	5th Annual Inspection
Stamp of authorised provider / Date / Signature	Stamp of authorised provider / Date / Signature

Invacare Sales Companies

Australia:

Invacare Australia Pty. Ltd.
1 Lenton Place, North Rocks NSW
2151
Australia
Phone: 1800 460 460
Fax: 1800 814 367
orders@invacare.com.au
www.invacare.com.au

United Kingdom:

Invacare Limited
Pencoed Technology Park, Pencoed
Bridgend CF35 5AQ
Tel: (44) (0) 1656 776 222
Fax: (44) (0) 1656 776 220
uk@invacare.com
www.invacare.co.uk

Canada:

Invacare Canada L.P.
570 Matheson Blvd East, Unit 8
CDN Mississauga, On. L4Z 4G4
Phone: (905) 890 8300
Toll Free: 800.668.5324
www.invacare.ca

Eastern Europe, Middle East & CIS:

Invacare EU Export
Kleiststraße 49
D-32457 Porta Westfalica / Germany
Tel: (49) (0)57 31 754 540
Fax: (49) (0)57 31 754 541
webinfo-eu-export@invacare.com
www.invacare-eu-export.com

Ireland:

Invacare Ireland Ltd,
Unit 5 Seatown Business Campus
Seatown Road, Swords, County Dublin
Tel : (353) 1 810 7084
Fax: (353) 1 810 7085
ireland@invacare.com
www.invacare.ie

New Zealand:

Invacare New Zealand Ltd
4 Westfield Place, Mt Wellington 1060
New Zealand
Phone: 0800 468 222
Fax: 0800 807 788
sales@invacare.co.nz
www.invacare.co.nz



Manufacturer:

Invacare Deutschland GmbH
Kleiststraße 49
D-32457 Porta Westfalica
Germany

1541361-N 2019-06-06



Making Life's Experiences Possible®



Yes, you can.®