

The Paravan wheelchair series

User manual PR Piccolino



Publisher and Copyright Holder: PARAVAN GmbH, 72539 Pfronstetten-Aichelau

Date of publication: 1.1.2017

Document: PR_Benutzerhandbuch_V2.3_EN

Dear customer,

Thank you very much for having chosen our PR series PARAVAN electric wheelchair.

You will find all the important information and tips you need on your new electric wheelchair in this User's Manual. Please carefully read the information on the pages to follow in order to make sure your electric wheel chair will give you many years of problem-free service. Keep this User's Manual in a handy place for later reference. Our user manual contains answers to questions relating to the operation and care of the electric wheelchair and its fittings. If you should have any questions or suggestions on the wheelchair, please do not hesitate to get in contact with us.

Your PARAVAN team

General

1.	Details on publisher.....	16
1.1	Your manufacturer.....	16
1.1.1	Copyright.....	17
1.1.2	Technical status of this documentation.....	17
2.	On this User's Manual.....	18
2.1	Disclaimer.....	19
2.1.1	Guarantee.....	20
2.1.2	Technical alterations.....	21
2.2	Target groups.....	23
2.3	Explanation of symbols.....	24
2.3.1	Structure of safety notices.....	25
3.	Safety note.....	26
3.1	General safety notes.....	26
3.1.1	Notes on usage.....	26
3.1.2	Notes on usage.....	30
3.1.3	Notes on transport.....	31
4.	Functional description.....	32
4.1	Manufacturing standard.....	32
4.2	Appropriate usage.....	33
4.2.1	Usage of the electric wheelchair.....	34
4.3	Approvals, certifications.....	35
4.3.1	EU approval as a driver seat.....	35
4.3.2	Clearance certification as hazardous cargo (accumulator).....	36
4.3.3	German Ordinance on Assistive Technology (HMV No.).....	37
4.3.4	Definition of assistive technology (excerpt).....	37

Information

5.	Details relating to the product.....	38
5.1	Trademark and type labelling (ratings plate).....	38
5.2	Position of the type label (ratings plate).....	39
5.3	Details on your electric wheelchair.....	40
5.3.1	Your wheelchair's ratings plate.....	40
5.4	Accessories.....	41
5.4.1	Accessories included.....	41
5.4.2	Accessories deliverable.....	41
6.	Description/Functioning or your electric wheelchair.....	42
6.1	The specially developed orthopaedic seat.....	42
6.2	Joystick control.....	43
6.3	Special controls.....	43
6.4	Lift and tilt (seat inclination).....	44
6.5	Vibration-damped foot rests.....	44
6.6	Safe for traffic conditions according to German traffic law.....	45
6.6.1	Section 24 Special means of transport.....	45
7.	Overview of the PARAVAN electric wheelchair.....	46
7.1	Definition of vocabulary for parts and their positions.....	46
7.2	Definition of vocabulary for parts, place of installation, chassis.....	47

Prepare

8.	Handing over the electric wheelchair.....	49
8.1	Receiving your new electric wheelchair.....	49
8.2	How your electric wheelchair is delivered to you.....	49
8.3	Tools included with the delivery.....	50

9.	Settings on your electric wheelchair; electronic.....	51
10.	Settings on your electric wheelchair; mechanical	52
10.1	Receiving your new electric wheelchair	52
10.2	The armrest cushion.....	53
10.2.1	Setting the armrest cushion.....	53
10.2.2	Setting the horizontal position of the armrest cushion.....	54
10.3	The armrest.....	55
10.4	Set the height of the armrest	56
10.5	Set the angle of the armrest.....	58
10.6	Set the projection of the armrest.....	59
10.7	Setting the movability of the control panel	60
10.8	The foot support unit.....	61
10.8.1	Setting the lower leg length.....	61
10.8.2	Setting the tibialis angle.....	62
10.8.3	Setting the foot rest angle.....	63
11.	Use of the special orthopaedic seat.....	64
11.1	Setting the back support	64
11.1.1	Setting the back support angle.....	64
11.1.2	Setting the head support.....	65
11.1.3	Setting your sitting position	66
11.2	Setting your lying position.....	67
11.3	Setting the standing up position.....	68
12.	Removing and reattaching the chassis cladding	69
12.1	Removing and reattaching the rear cladding	69
12.2	Removing and reattaching the side cladding.....	70

Operate

13.	Driving your electric wheelchair.....	71
13.1	Insurance, civil liability insurance	71
13.2	Functional checking before driving.....	72
13.3	Buckling the safety belt	73
13.4	Controlling the electric wheelchair's travel direction.....	74
13.5	Driving a curve.....	75
13.6	Braking your electric wheelchair	76
13.6.1	Braking systems on your electric wheelchair	76
13.7	Braking the electric wheelchair.....	77
13.8	Travelling on hills, uphill and downhill travel.....	78
13.9	The driving programmes / drive levels	79
13.10	Driving manually, manual operation	80
13.10.1	Use of the brake release lever (emergency release)	80
13.11	Terrain requirements, surfaces	81
13.11.1	Ability to ford, or drive through water	81
13.11.2	Climbing and overtaking capacity	82
13.11.3	Load-bearing capacity	82
13.11.4	Impassible surfaces or areas.....	82
13.11.5	Slippery surfaces, traction.....	82
14.	Parking and storing your electric wheelchair	83
14.1	Immobiliser/key function	83
15.	Loading and transporting your electric wheelchair.....	84
15.1	Rules when loading wheelchairs.....	84
15.2	Securing your electric wheelchair, lashing	85
15.3	Fasten the seatbelt in a moving vehicle.....	86
15.4	Securing the wheelchair with a 4 point strap restraint system.....	87
15.5	Occupant restraint instruction	88
15.6	Dahl Docking Systems Assembly	90

15.6.1	Content of Dahl docking stations	92
15.6.2	Fitting of the Dahl lock plate on wheelchair.....	94
15.6.3	Description of the Dahl Docking system functions	99
15.6.4	Securing the wheelchair in the docking station	100
15.6.5	Release from the docking station.....	102
15.6.6	Manual release in case of electric failure	103
16.	Controls	104
16.1	Control panel R-NET CJSM2	104
16.1.1	Overview of the control elements	104
16.1.2	Status display.....	105
16.1.3	Start, switch off.....	106
16.1.5	Switch direction indicator on and off	107
16.1.4	Switch light on and off.....	107
16.1.6	Switch hazard lights on and off	108
16.1.7	Driving functions overview	109
16.1.8	Select drive program, drive.....	110
16.1.9	Electrical seat adjustment.....	111
16.1.10	Set time/date	112
16.1.11	Show/hide clock, configure 12h/24h display.....	113
16.1.13	Adjust display brightness	114
16.1.12	Adjust display brightness, automatic	114
16.1.14	Block the controls (with the wheelchair switched on)	115
16.1.15	Release the controls (with the wheelchair switched off)	115
16.2	Control panel R-NET CJSM-L	116
16.2.1	Overview of the control elements	116
16.2.2	Status display.....	117
16.2.3	Start and switch off	118
16.2.5	Switch direction indicator on and off	119

16.2.4	Switch light on and off.....	119
16.2.6	Switch hazard lights on and off	120
16.2.7	Driving functions overview	121
16.2.8	Select drive program, drive.....	122
16.2.9	Electrical seat adjustment.....	123
16.2.10	Set time/date	124
16.2.11	Show/hide clock, configure 12h/24h display.....	125
16.2.13	Adjust display brightness	126
16.2.12	Adjust the display background and brightness	126
16.2.14	Block the controls (with the wheelchair switched on)	127
16.2.15	Release the controls (with the wheelchair switched off)	127

Help

17.	Getting out of your electric wheelchair	128
17.1	Procedure when getting out from the side.....	129
18.	Care and maintenance.....	130
18.1	Service partners	130
18.2	Cleaning and care	131
19.	Disposal and environmental protection.....	132
19.1	Packaging materials	133
19.2	Re-commissioning	134
19.3	Notes on transfer	135
20.	Correcting failures.....	136
20.1	Flashing codes indicating the status of the control panel	136

21.	Electrical system	138
21.1	Automatic safety switches.....	138
21.2	The main safety switch.....	139
21.2.1	Resetting the main safety switch.....	139
21.3	The secondary safety switch.....	140
21.3.1	Resetting the secondary safety switch.....	140
21.4	Overload protection.....	141
21.4.1	Resetting the overload protection:.....	141
21.5	Facility to connect ancillary devices.....	142
21.6	The lighting system.....	143
21.7	The maintenance-free accumulators.....	144
21.8	Notes on accumulators.....	145
21.9	Changing your accumulators.....	146
21.10	Charging your electric wheelchair.....	147
21.10.1	Procedure for charging your electric wheelchair.....	148
21.10.2	The charging device.....	149
21.10.3	Positioning the charging device.....	149
22.	Technical equipment	150
22.1	Technical data and dimensions.....	150
22.2	Replacement parts.....	153
23.	Systems and technical documentation	154
23.1	How to deal with closed accumulators.....	154
23.2	Customer service book.....	155
23.3	EU Declaration of Conformity.....	156
23.4	Protocol of the handover briefing.....	157

Fig. 1:	QR Code.....	16
Fig. 2:	Direction of travel.....	18
Fig. 3:	Safety note.....	25
Fig. 4:	TÜV Logo.....	35
Fig. 5:	Ratings plate.....	38
Fig. 6:	Location, ratings plate.....	39
Fig. 7:	Docking station.....	41
Fig. 8:	Front illumination.....	45
Fig. 9:	Rear illumination.....	45
Fig. 10:	Overview of wheelchair.....	46
Fig. 11:	Components, rear of chassis.....	47
Fig. 12:	Components, front of chassis.....	48
Fig. 13:	Socket wrench.....	50
Fig. 14:	Allen key.....	50
Fig. 15:	Angled arm rest cushion.....	53
Fig. 16:	Position of armrest cushion.....	54
Fig. 17:	Checking the position of the armrest.....	55
Fig. 18:	Height of arm rest.....	56
Fig. 19:	Lever, clamping screw.....	57
Fig. 20:	Armrest angle.....	58
Fig. 21:	Armrest projections.....	59
Fig. 22:	Swivel mechanism.....	60
Fig. 23:	Lower leg length.....	61
Fig. 24:	Tibialis angle.....	62
Fig. 25:	Foot rest angle.....	63
Fig. 26:	Back support angle.....	64
Fig. 27:	Head support.....	65
Fig. 28:	Sitting position.....	66
Fig. 29:	Lying position.....	67

Fig. 30:	Stand-up position.....	68
Fig. 31:	Rear cladding	69
Fig. 32:	Rear light and cable	69
Fig. 33:	Side cladding.....	70
Fig. 34:	Front headlight, cable	70
Fig. 35:	Brake release lever (emergency release)	72
Fig. 36:	Fastening the seat belt.....	73
Fig. 37:	Belt fastener.....	73
Fig. 38:	Joystick	74
Fig. 39:	Brake release lever (emergency release)	80
Fig. 40:	Securing point at front.....	85
Fig. 41:	Securing point at rear	85
Fig. 42:	Illustration of improper belt-restraint fit	86
Fig. 43:	Illustration of proper belt-restraint fit.....	86
Fig. 44:	Rear securement points	87
Fig. 45:	Front securement points	87
Fig. 46:	Positioning the occupant restraint with 4 point strap system	88
Fig. 47:	Positioning the occupant restraint for use with dahl docking system only	89
Fig. 48:	Dahl docking system	90
Fig. 49:	Content of Dahl Docking Station MK II standard set # 501750.....	92
Fig. 50:	Content of Dahl VarioDock™ standard set # 503600	93
Fig. 51:	Paravan Kit for Dahl docking station.....	94
Fig. 52:	Torx 27.....	94
Fig. 54:	Main Cable battery.....	95
Fig. 55:	Disconnect battery.....	95
Fig. 53:	Knurled screws Paravan.....	95
Fig. 56:	Rear and side panels Paravan.....	95
Fig. 58:	Position the Dahl system	96
Fig. 57:	Remove batteries Paravan	96

Fig. 59:	Fasten the Dahl system.....	96
Fig. 60:	System functions Dahl	99
Fig. 61:	Manual release step 1	103
Fig. 62:	Manual release step 2	103
Fig. 63:	Control panel R-NET CJSM2	104
Fig. 64:	Function keys	105
Fig. 65:	Status display.....	105
Fig. 66:	“On / off” key.....	106
Fig. 67:	Speed control (tortoise) active	106
Fig. 69:	Light on and off.....	107
Fig. 70:	Turn signal right / left	107
Fig. 68:	Light symbol (colour).....	107
Fig. 72:	Hazard lights on / off.....	108
Fig. 71:	Symbols (colour).....	108
Fig. 73:	Driving functions.....	109
Fig. 74:	Charging status indicator (driving function blocked).....	109
Fig. 75:	Select drive program.....	110
Fig. 76:	Joystick travelling direction	110
Fig. 77:	Display of seat functions.....	111
Fig. 78:	“Set time” function menu	112
Fig. 79:	Setting the time and date	112
Fig. 80:	Set clock to visible/invisible.....	113
Fig. 82:	Setting the display brightness.....	114
Fig. 81:	Autom. display brightness	114
Fig. 84:	Turn signal right / left	115
Fig. 83:	Lock symbol	115
Fig. 85:	Control panel R-NET CJSM-L	116
Fig. 86:	Function keys	117
Fig. 87:	Status display.....	117

Fig. 88:	“On / off” key	118
Fig. 89:	Speed control (tortoise) active	118
Fig. 91:	Light on and off.....	119
Fig. 92:	Turn signal right / left	119
Fig. 90:	Light symbol (colour).....	119
Fig. 94:	Hazard lights on / off.....	120
Fig. 93:	Symbols (colour).....	120
Fig. 95:	Driving functions.....	121
Fig. 96:	Driving function blocked.....	121
Fig. 97:	Select drive program.....	122
Fig. 98:	Joystick travelling direction	122
Fig. 99:	Display of seat functions.....	123
Fig. 100:	“Set time” function menu	124
Fig. 101:	Setting the time and date	124
Fig. 102:	Set clock to visible/invisible.....	125
Fig. 104:	Setting the display brightness.....	126
Fig. 103:	Setting the display background	126
Fig. 106:	Blocking the controls.....	127
Fig. 105:	Controls blocked – block symbol	127
Fig. 107:	Move, foot rests	129
Fig. 108:	Move, armrest	129
Fig. 109:	Recycling	133
Fig. 110:	Main safety switch, activ	139
Fig. 111:	Main safety switch.....	139
Fig. 112:	Sec. safety switch, activ.	140
Fig. 113:	Secondary safety switch	140
Fig. 114:	Front illumination	143
Fig. 115:	Rear illumination.....	143
Fig. 116:	Power connection.....	146

Fig. 117:	Refitting, accumulator	146
Fig. 118:	Plug in the charging cable.....	148
Fig. 119:	Pos. the charging device	149
Fig. 120:	EU Declaration of Conformity	156

1. Details on publisher

1.1 Your manufacturer



Fig. 1: QR Code

PARAVAN GmbH
Main office / HQ/ Production Plant



Paravanstraße 5-10, D-72539 Pfronstetten-Aichelau

- > Phone: +49 (0) 73 88 / 99 95-91
- > Fax: +49 (0) 73 88 / 99 95-999
- > Email: info@paravan.com
- > Internet: www.paravan.com
- > Managing Director: Roland Arnold



Many mobile phones and PDAs contain an integrated camera and software that allows you to interpret QR codes so that you can read our contact information directly into the address book of your mobile phone or PDA.

1.1.1 Copyright

This documentation and all its constituent sections are protected by copyright. The rights based on this copyright, in particular those in relation to translation, reprinting, representation, extraction of illustrations and tables, broadcast, microfilming or any other means of reproduction and saving in data processing systems, even if only excerpts are used, are reserved. Any reproduction of this work or of any parts of this work is only permitted even in exceptional cases within the limits set by the terms of the copyright law of the Federal Republic of Germany of 09 September 1965 in its version currently in force. It will always be liable for payment. Any infringements will be subject to the penal clauses of that copyright law.

- > Copyright © PARAVAN GmbH 2017. All rights reserved!

1.1.2 Technical status of this documentation



All details on technical data and/or specifications, illustrations and information in this User's Manual correspond to the status as on close of press in December 2016.

The User's Manual for the PR50 electric wheelchair was written in the German language and may be translated into other languages. In case of any inconsistencies, the German version shall be legally binding.



Fig. 2: Direction of travel

This User's Manual does not represent product documentation in the sense of a set of maintenance and repair instructions, and is thus not suitable for use in executing maintenance and repair work by its possessor, or for instructing on how to execute such work. You are in receipt of information on the nature of the electric wheelchair model and on its use over its entire life cycle from transport (delivery) to decommissioning (taking out of service). Below are listed and described the product's most important features. All product features mentioned may be combined variously in different models, and functions and may differ from the standard version.

-  This User's Manual forms an integral part of this electric wheelchair product and must always be stored in the vicinity of the electric wheelchair in order to allow you to access the important information it contains quickly.
-  All page and directional indications made in the documentation are always given from the point of view of the operator in the direction of travel of the device.

2.1 Disclaimer

Only by observing and putting into practice the knowledge provided by this User's Manual can the electric wheelchair be guaranteed error and fault free operation. PARAVAN GmbH does not take any responsibility for or give any guarantee against damages or operational interruptions that may be caused during operation by the non-observance of the instructions contained in this User's Manual or by any modifications made to the electric wheelchair.

In order to ensure the fault-free operation of your electric wheelchair, please observe the maintenance instructions and intervals.

 See Section "18 Care and maintenance"

2.1.1 Guarantee

Guarantee cover is defined exclusively by the relevant provisions set by PARAVAN.

Expressly excluded from guarantee entitlements is any damage resulting from:

- › Wear and tear
- › Inappropriate operation or usage; e.g. overloading
- › Incorrect/Irregular maintenance
- › Incorrect/Irregular care



See your personal "Guarantee card"

2.1.2 Technical alterations

Any modifications made to the safety equipment and technical changes to the electric wheelchair, however small, are absolutely prohibited. All alterations must be executed by PARAVAN GmbH.

PARAVAN GmbH reserves the right to make technical alterations and improvements to the product in the interests of our customers and due to advancing technology.



Any modification not approved by PARAVAN GmbH made to the electric wheelchair shall extinguish any warranty or guarantee entitlement. In addition, dangerously faulty functioning cannot be ruled out.

2.2 Target groups

The operator must attain or acquire a familiarity with the following points before putting the electric wheelchair into operation:

- › Knowledge of the contents of the User's Manual on the how to use the vehicle, the electric wheelchair, safely and how to move it about.
- › Knowledge of the safety and operational rules contained in it and of how to recognise possible hazards and dangerous situations for the user him or herself and for the environment.



For their own safety, only trained and authorised persons should use an electric wheelchair. As a user, you have received sufficient instruction during the handover of the wheelchair. Contact us where necessary.



See Section "1.1 Your manufacturer"



See Section "23.4 Handover briefing"



WARNING

Danger of personal injury when operating the electric wheelchair in a state not matching its state upon delivery.

Material damage to the electric wheelchair through non-authorized or incorrectly installed components.

- › Do not make any technical modifications to your electric wheelchair.
- › Only operate your electric wheelchair in its original state upon delivery.
- › Use only original or authorised replacement parts.
- › The operational condition of the electric wheelchair should be checked before any use of it.

2.3 Explanation of symbols

You will come across the following symbols and warning signs while reading the User's Manual.



The "Caution, Danger" logo

Calls your attention to danger points. The preventative measures contained in the associated text should always be followed. This symbol always appears with an associated signal word which indicates the degree of danger.

- > **Danger!** - Imminent danger to life and limb (irreversible).
- > **Warning!** - Possible danger to life and limb (irreversible).
- > **Caution** - Possible danger to life and limb (reversible).
- > **Caution** - possible material damage to the vehicle.



Additional information to the user, e.g. to make use of the electric wheelchair easier and/or to prevent material damage to the electric wheelchair.



This symbol refers the user to another section or more detailed documentation, e.g. to the annexes to this User's Manual.

2.3.1 Structure of safety notices

You can find the following information in the safety notes:

- > Warning or hazard symbol ①.
- > Type and source of hazard ②.
- > Signal word ③.
- > Consequences of occurrence ④.
- > Preventative action ⑤.



Fig. 3: Safety note

3. Safety note

3.1 General safety notes

3.1.1 Notes on usage

You must under all circumstances observe the following safety notes for your own safety, for that of people in your vicinity and to protect the environment.

 DANGER!
<p>Danger of crushing by contact with moving parts; e.g. Through the rotation of the drive wheels or the Lifting movement of the lift arm and the horizontal movement of the seat.</p> <p>Danger of fall through accidental movement of the electric wheelchair due to the brake being left off.</p> <p>Danger of fall through abrupt braking of the electric wheelchair where the vehicle loses power.</p> <ul style="list-style-type: none"> › Do not make contact with moving parts. › Accompanying persons should not make any contact with danger areas when operating the electric wheelchair. › The brake release lever must be in the "LOCK" position. › Never switch off or cut off power to the electric wheelchair while it is moving.

 WARNING
<p>Danger of tipping over for persons when using the electric wheelchair on surfaces with a slope of more than 10°.</p> <p>Danger of tipping over for persons when using the electric wheelchair on downhill slopes with the seat position in its forwardmost position.</p> <p>Danger of tipping over for persons when using he electric wheelchair when driving over obstacles.</p> <ul style="list-style-type: none"> › Avoid paths with any inclination of more than 10°. › When travelling downhill move the electric wheelchair's seat to the back. › Do not drive over obstacles higher than 60 - 70mm. › Always drive with your safety belt on.

 **WARNING**

Danger of personal injury when operating the electric wheelchair in a state not conforming to its state upon delivery.
Material damage to the electric wheelchair through non-authorized or incorrectly installed components.

- › Do not make any technical changes to your electric wheelchair.
- › Only operate your electric wheelchair in its original state upon delivery.
- › Use only original or authorized replacement parts.
- › The operational condition of the electric wheelchair should be checked before any use of it.

 **WARNING**

Danger of injury for persons when travelling with the electric wheelchair over impassible surfaces.
Danger of fall and of tipping over for persons when operating the electric wheelchair on surfaces with reduced load-bearing capacity.
Material damage to the electric wheelchair through mechanical and physical forces due to travelling over impassible surfaces.

- › Avoid travelling on slick, slippery, or greasy surfaces (e.g. ice, snow, wet grass and leaves, etc.).
- › Avoid travelling through water at a depth of 50mm or deeper.
- › Observe the permitted total weight of the vehicle.
- › Observe the load capacity (e.g. of bridges and over passes) and condition of the travelling surface.
- › Always drive with your safety belt on.

3.1.2 Notes on usage

 CAUTION	
<p>Material damage to the electric wheelchair through overloading the vehicle.</p> <p>Material damage to the electric wheelchair through the effect of heat greater than 41°C.</p> <p>Material damage to the electric wheelchair through battery overload on downhill slopes.</p>	
<ul style="list-style-type: none"> › Use your electric wheelchair exclusively for the purpose for which it was intended. › Overloading the electric wheelchair (by an additional person or other loads travelling on it) is prohibited. › Protect your electric wheelchair from strong sun and other sources of heat. › Switch on electrical devices (e.g. the electric wheelchair's lights) when travelling downhill. 	

3.1.3 Notes on transport

 CAUTION	
<p>Material damage to the electric wheelchair through slipping from ramps or lift while being loaded.</p> <p>Material damage to the electric wheelchair through being secured and transported improperly in and electric wheelchair transporter.</p>	
<ul style="list-style-type: none"> › Secure ramp from slippage. › Both the ramp and the electric wheelchair transporter must be positioned on even and firm surfaces. › The ramp or lift must be clean and dry. › The ramp must be wider than the electric wheelchair and should be clearly visible to allow corrective steering. › Mount the ramp and lift in a single movement in order to prevent the electric wheelchair rolling backwards. › Secure the electric wheelchair in the transporter according to the usual legal regulations. › Use only suitable and authorised securing equipment. › Switch the electric wheelchair off during transport. 	

4. Functional description

4.1 Manufacturing standard

The PARAVAN electric wheelchair is a multifunctional electric wheelchair which, due to its compact design, is ideally suited to both indoor and outdoor usage.

The electric wheelchair is built and tested to ensure the highest possible level of safety for its operator and his or her immediate environment. Our products are tested for freedom from any flaws after their manufacture. However, if any failure in functioning should appear on your wheelchair, please contact your dealer or PARAVAN GmbH directly in order to have that failure corrected as quickly as possible.

PARAVAN electric wheelchairs are manufactured and checked in conformity with:

- › DIN EN 12184 Electric wheelchairs and scooters and their chargers.

and has been rated by this standard in Category B.

4.2 Appropriate usage

The PARAVAN electric wheelchair is functionally and structurally intended for the transport of a single person in indoor and outdoor areas. The interface in relation to operation by the user and the liability of the manufacturer of the electric wheelchair is the control panel, including its joystick and any optional operational units for special operation.



The electric wheelchair is suitable exclusively for the applications listed in the section entitled "Usage of the vehicle".



See Section "3 Notes on safety"



See Section "4.2.1 Usage of the electric wheelchair"

4.2.1 Usage of the electric wheelchair

- unproblematic

- › Boarding by a single person with a maximum body weight of 160kg.
- › Usage as driver or passenger seat, depending on the associated accessories.
- › Usage in areas governed by German traffic law (public roads and thoroughfares), on condition that full and fully functioning lighting is installed.

 See Section "13 Driving the electric wheelchair"

- problematic or prohibited

- › Use as a tractor means of transport of loads or more than one person.
- › Use of the electric wheelchair in extreme climatic conditions (heat/cold/precipitation).

 See Section "2.1 Disclaimer"

 See Section "3 Notes on safety"

4.3 Approvals, certifications

4.3.1 EU approval as a driver seat

The anchoring of the safety belt has been certified and approved in accordance with 76/115/EEC as has the seat in relation to its anchoring in accordance with 74/408/EWG with the Paravan docking system.

 DANGER!
<p>Potential risk of injury or serious injury or death</p> <p>In conjunction with the Dahl Docking system the wheelchair has been successfully crash-tested according to ISO 7176-19:2008 - Wheeled mobility devices for use as seats in motor vehicles. The test was carried out with vehicle anchored safety belt system only. The integrated 3- or 4-point seat belt should not be used or relied on for occupant restraint in a moving vehicle. Use a vehicle anchored occupant restraint system instead.</p>

- › Technical Reports Nos. 08-00719-CP-GBM and 08-00723-CP-GBM.

 See Section "23 Annexes and technical documentation"



Fig. 4: TÜV Logo

4.3.2 Clearance certification as hazardous cargo (accumulator)

PARAVAN GmbH uses accumulators that are rated as "non-hazardous cargo" on condition that the relevant accumulators are not suffering mechanical damage of any type.

The maintenance-free VRLA accumulators and the equally maintenance-free lead gel accumulators are classified as leak-proof, non-hazardous cargo for any form of transport according to:

- › IATA, Rule A 67
- › ADR, Rule 238 B
- › IMDG, Rule 238.2

UN 2800 Special Provisions.



See "Clearance certification as hazardous cargo"



You will receive the appropriate Clearance certificate for your accumulators during the handover of your wheelchair.

4.3.3 German Ordinance on Assistive Technology (HMV No.)

PARAVAN electric wheelchairs are approved according to the following assistive technology regulations:

- › Doctor's regulations in Nordwürttemberg – rules, regulations, provisions and services, Pages B 2 and – 1 ff as an assistive technology under assistive technology number
- › HMV No. 18.99.06.1048.



Approval from AOK on 09 June 2008 in accordance with Section 126 Para. 3 of German Social Code V Catalogue of Assistive Technologies in accordance with Section 139 German Social Code V IKK Federal Association - Federal Associations of Health Insurance Funds on 19 June 2008.

4.3.4 Definition of assistive technology (excerpt)

Assistive technologies are specialised medical services or objects that secure the success of a treatment by their provision of a substitute, supportive or relief effect, or make it possible to overcome a physical disability. They include prostheses, orthopaedic and other assistive devices, aids to sight, specialised materials or technical products...

5. Details relating to the product

5.1 Trademark and type labelling (ratings plate)

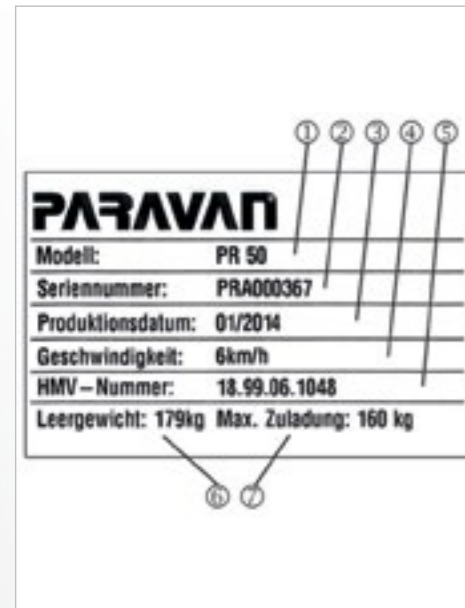

You can read this information from the device's ratings plate. They are very important in all correspondence with PARAVAM GmbH in guaranteeing that you receive the technically correct advice.

- > Model designation ①
- > Series number, Chassis no. ②
- > Date of manufacture ③
- > Max. speed ④
- > HMV number ⑤
- > Weight of electric wheelchair when empty ⑥
- > Maximum load (body weight) ⑦



See Section "5.3.1 Your electrical wheelchair's ratings plate"

Fig. 5: Ratings plate

5.2 Position of the type label (ratings plate)

One copy of the type label (ratings plate) has been affixed to your electric wheelchair. The type label (ratings plate) is about 70mm by 40mm in size.

- > The type label (ratings plate) is positioned on the lower right of your wheelchair, next to the battery holder ①.



Fig. 6: Location, ratings plate

5.3 Details on your electric wheelchair

Please make sure that these details are listed when the wheelchair is handed over to you or, if necessary, enter the information yourself so that you have it to hand at all times.

Date of delivery/handover

>

Handed over by (dealer or branch office)

>

5.3.1 Your wheelchair's ratings plate

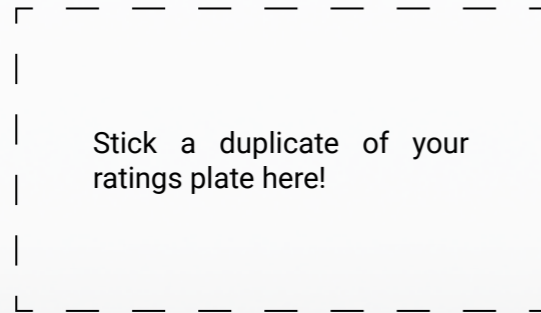

5.4 Accessories

5.4.1 Accessories included

- > Charging device with charging cable.
- > User's Manual.
- > Socket spanner with T grip, SW 13.
- > Allen key, size 5.
- > Magnetic key, optional, depending on equipment.

5.4.2 Accessories deliverable

- > PARAVAN docking station to allow you to secure the electric wheelchair easily and quickly in your vehicle, e.g. when the electric wheelchair is being used as a driver's seat.



Fig. 7: Docking station

6. Description/Functioning or your electric wheelchair

6.1 The specially developed orthopaedic seat

The specially developed orthopaedic seat is an in-house development of PARAVAN GmbH that has been adjusted precisely to the needs of our customers. It is equipped with the following:

- › The integrated 3- or 4-point seatbelt should not be used or relied on for occupant restraint in a moving vehicle.
- › Special suspension in the seat to prevent strain on thigh muscles.
- › A 4-position lumbar support in the seat back to ensure the correct position of the pelvis.
- › A 6-axis adjustment of the seat arms with 12 individual positions to support your arms in an ideally fatigue-free position.
- › MeshTex textile covering made of active breathable nano fibres to reduce the risk of pressure sores.

6.2 Joystick control

Using the joystick, the driving console and its integrated control panel, you can select and trigger all functions of the electric wheelchair; such as:

- › The electric wheelchair's steering
- › The electric wheelchair's braking behaviour
- › Driving speed, control of the two drive motors
- › Secondary functions, depending on the control panel and equipment being used.

6.3 Special controls

A variety of special controls can be used on the PARAVAN electric wheelchair, including the following:

- › Chin control
- › Environmental control
- › etc.



If you have any special requirements or suggestions on this topic, please do not hesitate to get in contact with us. Thank you.

6.4 Lift and tilt (seat inclination)

The electric wheelchair is equipped with a sturdy single-lever lift, which fully extended can reach a height of 80cm. This ensures that you have the largest possible radius of action in your everyday household and work environment.

At the press of a button you can adjust the seat tilt (inclination) as follows:

- › to the front, which will give you assistance in standing up
- or
- › to the rear, for relaxing, to prevent pressure sores, to support your lower body and to distribute your weight more evenly.

 See Section "11 The special orthopaedic seat, operation"

6.5 Vibration-damped foot rests

- › Impact-damped, separate or conjoined in order to counter spasticity.
- › Depending on the equipment, they may be electrically adjustable in terms of length and angle.

6.6 Safe for traffic conditions according to German traffic law

Optionally, the PARAVAN electric wheelchair can be enhanced to become a vehicle approved for use in road traffic using:

- › LED headlights for the best possible illumination ①.
- › LED directional indicators ②.
- › LED rear lights for the best possible visibility ③.
- › Lateral markings in the centres of the wheels using yellow reflectors.



Fig. 8: Front illumination

6.6.1 Section 24 Special means of transport

 Wheelchairs are mentioned in German traffic law. In that law, it is stated:

- › (1) Push and grip wheelchairs, sleds, prams, scooters, children's bicycles and other similar means of transport are not vehicles in the sense of German traffic regulations.
- › (2) Medical wheelchairs and other wheelchairs as mentioned in Paragraph 1 may circulate wherever pedestrian traffic is permitted, but only at walking speed.



Fig. 9: Rear illumination

7. Overview of the PARAVAN electric wheelchair

7.1 Definition of vocabulary for parts and their positions



The following terms for components and parts will be used in this user's manual. Their position on the wheelchair is shown in the illustration.

- > Control panel with joystick ①
- > Repositionable armrest on multiple axes ②
- > Back rest (electric) ③
- > Head support ④
- > Foot plate/foot rests ⑤
- > Brake release lever, emergency release ⑥
- > Drive wheel, puncture resistant as standard ⑦
- > Battery holder ⑧
- > Trimming ⑨
- > Rear wheel, puncture resistant as standard ⑩

Fig. 10: Overview of wheelchair

7.2 Definition of vocabulary for parts, place of installation, chassis

The following terms for components and parts will be used in this user's manual. Their assembled position on the chassis of your electric wheelchair is shown in the illustration.

- > Seat section ①
- > Seat guides ②
- > Lift arm ③
- > Rear wheel ④
- > Rigging eyelet, rear ⑤
- > Floating axle ⑥
- > Drive motor for lift arm ⑦
- > Actuator module ⑧
- > Battery holder ⑨
- > Accumulator (battery) ⑩



Fig. 11: Components, rear of chassis

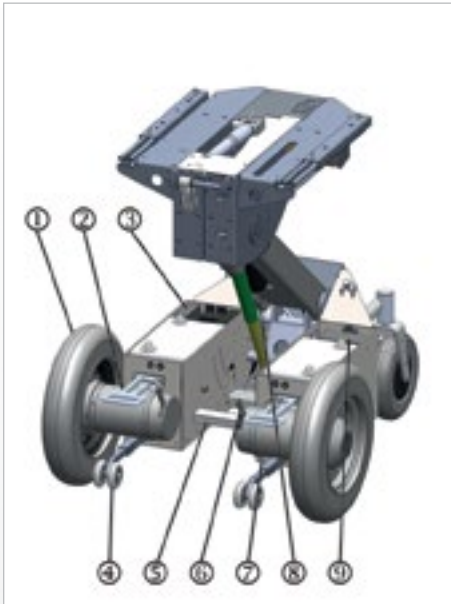

- > Drive wheel ①
- > Rigging eyelet ②
- > Control devices ③
- > Stabilizer, anti-tipper ④
- > Fitting for docking station ⑤
- > Brake release lever, emergency release ⑥
- > Drive motor ⑦
- > Lift motor with lifting rod and gearing ⑧
- > Bracket for ancillary components ⑨

Fig. 12: Components, front of chassis

8. Handing over the electric wheelchair

8.1 Receiving your new electric wheelchair

Check that your your electric wheelchair is complete and compare the state in which it was delivered with what is indicated on your order. Where there is any doubt, contact PARAVAN GmbH immediately! Check (visually) that your electric wheelchair is in proper order. Report any damage that may be due to transport or delivery immediately in writing to your

› dealer, forwarder or medical supplier

and

› PARAVAN GmbH



See Section "1.1 Your manufacturer"

8.2 How your electric wheelchair is delivered to you

The electric wheelchair will be in the following state of assembly, ready for use and operation:

- › Fully assembled and equipped in accordance with your order instructions.
- › All components and auxiliary elements are pre-set to your body mass as it figured in your order.
- › Ready charged accumulators.

8.3 Tools included with the delivery

You will receive the following tools along with your electric wheelchair:

- › Socket spanner with T grip, SW 13.

- › Allen key, size 5.



Fig. 13: Socket wrench



Fig. 14: Allen key

9. Settings on your electric wheelchair; electronic

The settings and configuration needed for PARAVAN controls are very complex and for your own safety can only be done by your service technician. All parameters used in PARAVAN controls can be adjusted later to your needs and wishes. These parameters include:

- › All drive properties, such as starting and braking.
- › Steering behaviour.



Should you need or would like to have adjustments made to control parameters, please contact PARAVAN GmbH or your dealer.





See Section "1.1 Your manufacturer"

10. Settings on your electric wheelchair; mechanical

10.1 Receiving your new electric wheelchair

All mechanical components and equipment and operating elements are set to match your body mass. However, if any adjustment should be necessary, then it can be made at any time. Your PARAVAN electric wheelchair is build so that it can be adjusted to the needs of any body mass.

 For your own safety, please make sure all mechanical settings and changes to the wheelchair's equipment are made by your service technicians. No modifications made by the customer are permitted!

 See Section "23.4 Handover briefing"

10.2 The armrest cushion

 The armrest cushion can be folded vertically at its elbow and can be slit horizontally into position forwards and backward, thus allowing it to be set in a suitable position for every purpose and for every body mass.

10.2.1 Setting the armrest cushion

This instruction applies both to the left and right hand cushion.

- > Loosen the hexagonal cap nut ①.
- > Swing the armrest cushion ② into the desired position
- > Tighten the hexagonal cap nut ① to about 8 Nm.

 See Section "8.3 Tools provided"

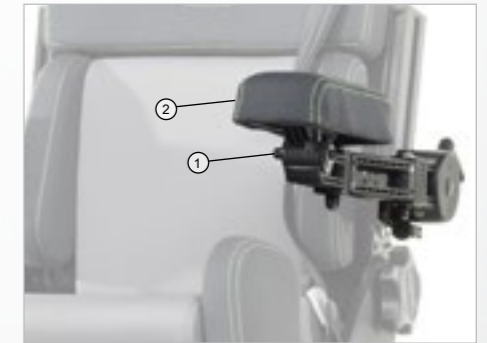

Fig. 15: Angled arm rest cushion

10.2.2 Setting the horizontal position of the armrest cushion

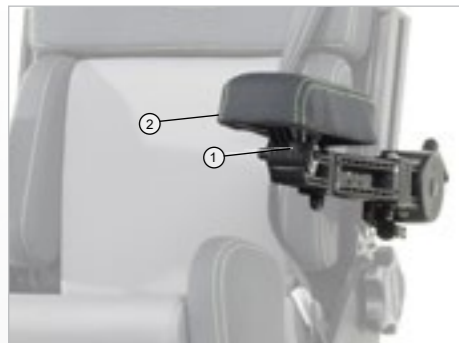

Fig. 16: Position of armrest cushion

This instruction applies both to the left and right hand cushion!

Take the following steps in the following sequence when checking or setting the position of the armrest cushion:

- > Loosen the wing nut ①.
- > Slide the armrest cushion ② back or forward into the desired position.
- > Tighten up the wing nut ① until it is hand tight.



See Section "8.3 Tools provided"

10.3 The armrest

The armrest can be moved in all directions horizontally (along its projection length) and vertically in terms of its height and of its angle, and can thus be set to suit every body mass.



It may be necessary to make a further change in the position of the armrest!

Take the following steps in the following sequence when checking or setting the position of the armrest:

- > Height ① of the armrest.
- > Angle ② of the armrest.
- > Projection ③ of the armrest.
- > Possible correction of the armrest cushion.



See Section "8.3 Tools provided"



Fig. 17: Checking the position of the armrest

10.4 Set the height of the armrest



Fig. 18: Height of arm rest

This instruction applies both to the left and right hand armrest!

i In its form and function, the clamping screw is essentially an eccentric clamp! That means that it works as follows:

- > Eccentric clamp is loose → the arm rest is locked or fixed in position.
- > Eccentric clamp is tight → the arm rest is loose and can be moved.

Take the following steps in the following sequence when setting the height of the armrest:

- > Tighten the clamping screw ①.
- > Slide the armrest ② along its guide rail into the desired position.
- > Loosen clamping screw ①.

After changing the position of the armrest, you may need to re-position the lever of the clamping screw, so that it does not represent any danger (of injury to passers by or of being knocked off).

- > Lift up lever ①.
- > Turn lever ① towards the rear, in direction of travel.
- > Lower lever ①.



Fig. 19: Lever, clamping screw

10.5 Set the angle of the armrest



Fig. 20: Armrest angle

The armrest pivots from its anchoring point. This allows the whole armrest to swivel upwards to allow you to sit in, stand up or move easily and comfortably.

This instruction applies both to the left and right hand armrest!

You have the following settings available:

- > Screw the knurled screw ① in → the angle of the armrest becomes more acute.
- > Screw the knurled screw ① out → the armrest lowers.



Do not force the knurled screw in or out. Raise the armrest a little to remove pressure on the knurled screw.

10.6 Set the projection of the armrest

This instruction applies both to the left and right-hand side, though you may need to rotate the screw in the opposite direction!

Take the following steps in the following sequence when setting the projection of the armrest:

- > Loosen the hexagonal cap nut ①.
- > Loosen the hexagonal cap nut ③.
- > Adjust the armrest cushion ② to the desired position.
- > Tighten the hexagonal cap nut ① to about 8 Nm.



See Section "8.3 Tools provided"

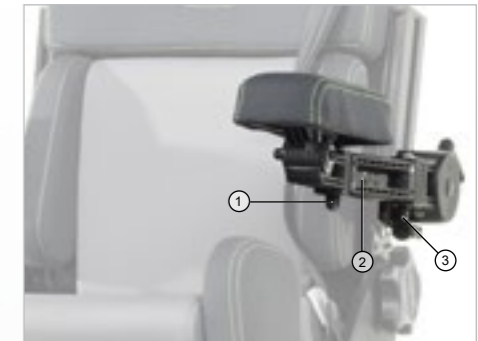

Fig. 21: Armrest projections

10.7 Setting the movability of the control panel



Fig. 22: Swivel mechanism

The horizontal swivel mechanism of the control panel can be set to adjust its level of stiffness (i.e. in terms of the responsiveness and movability of the joint).



This level of stiffness can only be set by your service technician!



See Section "8.3 Tools provided"

10.8 The foot support unit

Using the electric wheelchair's electrical angle and length compensation system, you can adjust the foot support unit electrically in terms of its length and its angle in relation to the seat. The angle of the foot rest can only be adjusted manually using an adjustment screw.

10.8.1 Setting the lower leg length

The projection and length of the lower leg can be set electrically using the PARAVAN control's length setting.

- > Select the menu in the control.
- > Make your setting.



See Section "16 Controls"



If this adjustment mode is not sufficient for your needs, then the foot support must be mechanically adjusted at the foot support ①!



Fig. 23: Lower leg length

10.8.2 Setting the tibialis angle



Fig. 24: Tibialis angle

The projection of the lower leg and of the tibialis angle (between the upper and lower leg) can be made using the angle setting of the PARAVAN control, depending on how your model is equipped.

- › Select the menu in the control.
- › Make your setting.



See Section "16 Controls"



Optional accessory: Not tested with DAHL docking system

10.8.3 Setting the foot rest angle

The angle of the foot rests can be set separately for each foot rest to match your individual needs.

The following settings are available:

- › Screw the adjustment screw inwards -> the foot rest is lowered.
- › Screw the adjustment screw outwards -> the foot rest is raised.



Do not force the adjustment screw in or out. Raise the foot rest a little to remove pressure on the adjustment screw.

Take the following steps in the following sequence when setting the angle of the foot rest:

- › Raise the foot rest ③.
- › Loosen the lock nut ①.
- › Screw the adjustment screw ② in or out as required.
- › Check your setting (lower the foot rest).
- › Tighten the lock nut ① to about 8 Nm.

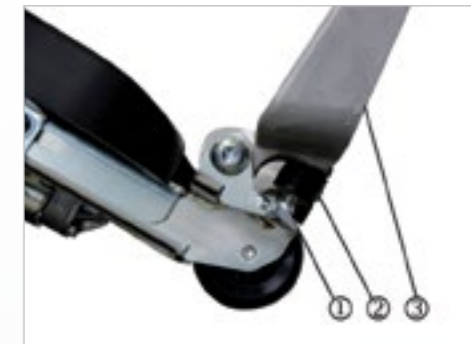

Fig. 25: Foot rest angle

11. Use of the special orthopaedic seat

11.1 Setting the back support

11.1.1 Setting the back support angle



Fig. 26: Back support angle

The back support and the back support angle can be changed electrically using the PARAVAN control.

- > Select the menu in the control.
- > Make your setting.



See Section "16 Controls"

11.1.2 Setting the head support

If you need the head support position to be change, you can adjust the height of the head support to your individual needs in 5 stages.

You have the following settings available:

Adjusting head inclination:

- > Push the head support ① into the required inclination
→ push the head support up backwards or forwards.

Height adjustment in five stages:

- > Push the head support ① into the required stage
→ pull the head support upwards or push it downwards. The head supports ② have five stages.

In order to remove the head support (e.g. at the hairdresser) you must pull it up over the final stage and pull it free. Do the same in reverse to replace it.



Fig. 27: Head support

11.1.3 Setting your sitting position



Fig. 28: Sitting position

The seat can be moved forward or backwards using the PARAVAN control if you have chosen this optional special accessory.

- > Select the menu in the control.
- > Make your setting.



See Section "3 Notes on safety"



See Section "16 Controls"

11.2 Setting your lying position

The seat can be moved into a lying position using the PARAVAN control.

The lying position function is not provided within the control. It must be set individually by the user.

Take the following steps in the following sequence when setting the lying position:

- > Select the menu in the control.
- > Move the lift arm upwards.
- > Set the required tilt for the seat. (Optional special equipment)
- > Set the required tilt for the back support.
- > Set the foot support angle and length. (Optional special equipment)



See Section "16 Controls"



Fig. 29: Lying position

11.3 Setting the standing up position



Fig. 30: Stand-up position

The seat can be moved into a stand-up position using the PARAVAN control.

The stand-up position function is not provided in the control. It must be set individually by the user.

Take the following steps in the following sequence when setting the stand-up position:

- › Select the menu in the control.
- › Move the lift arm up to the height of your bottom.
- › Fold the foot rest up.
- › Tilt the seat forward.
- › Push off from the seat and stand up.



See Section "16 Controls"

12. Removing and reattaching the chassis cladding

12.1 Removing and reattaching the rear cladding

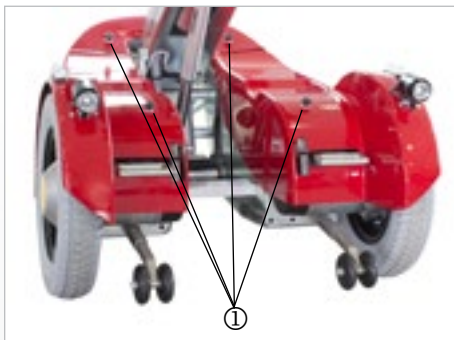

Fig. 31: Rear cladding



Fig. 32: Rear light and cable

The chassis cladding can be removed for maintenance, repair or cleaning.

Take the following steps in the following sequence when removing and reassembling the rear cladding:

- › Loosen and remove knurled screws ①.



Put aside the knurled screws and plastic washers.

- › Disconnect the cable for the rear light ② at the connection.
- › Remove the rear cladding.
- › Reassemble in the opposite sequence.

12.2 Removing and reattaching the side cladding

The chassis cladding can be removed for maintenance, repair or cleaning.

Take the following steps in the following sequence when removing and reattaching the side cladding:

- › Loosen and remove knurled screws ①.
- › Remove rear cladding.

 See Section "12.1 Removing and reattaching the chassis cladding"

- › Raise the side cladding at rear.
- › Disconnect the cable for the front headlight and directional indicator ② at the connection.
- › Remove side cladding from the front.
- › Reassemble in the opposite sequence.

 Make sure the plastic washers are present, as they protect the chassis components from damage.

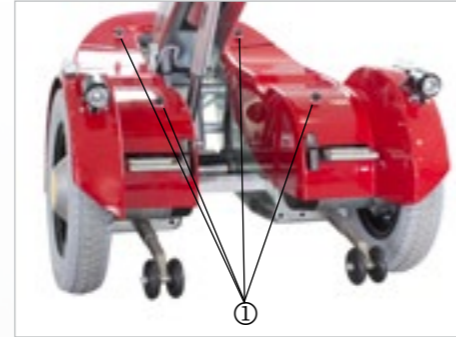

Fig. 33: Side cladding





Fig. 34: Front headlight, cable

13. Driving your electric wheelchair

13.1 Insurance, civil liability insurance

We recommend speaking with your insurance advisor before starting use, so that the use of the electric wheelchair is included in your insurance policies – in particular in your civil liability insurance.

 Please observe that for use on the public roads you may be legally required by the relevant legislation to have an insurance policy for use of your electric wheelchair.

 WARNING	
<p>Danger of personal injury when operating the electric wheelchair in a state not conforming to its state upon delivery. Material damage to the electric wheelchair through non-authorized or incorrectly installed components.</p>	
<ul style="list-style-type: none"> › Do not make any technical changes to your electric wheelchair. › Only operate your electric wheelchair in its original state upon delivery. › Use only original or authorised replacement parts. › The operational condition of the electric wheelchair should be checked before any use of it. 	

13.2 Functional checking before driving

For your own safety, you must check the following points before beginning any trip.





-  You may need to involve a second person for such a check.
 - › Check that the brakes are working.
-  The brake release lever ① must be positioned on "LOCK"; i.e. in its upward position.
 - › Charge state of your accumulators.
 - › Functional check on the lighting system:
-  See Section "13.10.1 Using the brake release lever (emergency release)"
-  See Section "21 Electrical system"



Fig. 35: Brake release lever (emergency release)

13.3 Buckling the safety belt



Fig. 36: Fastening the seat belt



Fig. 37: Belt fastener

-  Listen for an audible clicking into place of the buckle latch ② in the belt fastener ① when buckling the safety belt.

The function of the belt fastener is similar for all belt variants, including:

- › 2-point belt (lap belt).
- › 3-point belt in driver or passenger version.
- › 4-point belt (suspender belt).
- › Multipoint belt (special belt with several anchor points).

13.4 Controlling the electric wheelchair's travel direction

i The electric wheelchair is steered using the joystick on the drive panel.

The following basic steering options are available to you when you put the joystick in the following positions:

- › Joystick pushed forward → the electric wheelchair travels forward.
- › Joystick to left or right → the electric wheelchair changes its direction into the selected direction.
- › Joystick pulled backward → the electric wheelchair travels backwards.
- › Joystick in neutral position (in the middle) → brakes are active, no movement.

i To prevent the wheelchair from moving in an undesired way, do not make any sudden movements (drive commands) using the joystick! Practice using the controls in a safe and obstacle-free area.



Fig. 38: Joystick

13.5 Driving a curve

i The PARAVAN electric wheelchair is equipped with front-wheel drive. This means that when steering (driving on curves) the rear of the vehicle swings outwards.

How to drive around a curve:

- › Press the joystick in the desired direction of movement (forwards or backwards).

and at the same time

- › Press the joystick in the desired direction of steering (left or right).

For example:

- › Push the joystick to the top right (to "two-o'clock") from the user's point of view.
→ the electric wheelchair will steer right.

 See Section "3 Notes on safety"

13.6 Braking your electric wheelchair

13.6.1 Braking systems on your electric wheelchair

In order to guarantee the highest possible level of safety, the PARAVAN electric wheelchair uses two braking (safety) systems that work independently of each other. The functions of each of these safety systems are as follows:

- › Safety during travel:
By releasing the joystick (the joystick will always return to its neutral position in the middle) during travel, the motor brake engages automatically and brakes the electric wheelchair.
- › Safety where power fails or cuts out:
If the supply of current should become interrupted – e.g. by a the battery losing its charge – the magnetic safety brake is triggered and the electric wheelchair will come to a stop. Where this happens it can only be released again mechanically and moved manually.



See Section "13.10.1 Using the brake release lever (emergency release)"

13.7 Braking the electric wheelchair

The braking mechanism; i.e. the process from initiating the braking process until the electric wheelchair comes to a stop, depends very heavily on a number of factors, such as:

- › Surface and nature of the surface being travelled on.
- › Total weight of the electric wheelchair (vehicle plus driver).



On braking during cruising speed at about 6km/h, your electric wheelchair has a braking distance of about 1 metre!



When the brake is engaged at high speeds, specially in downhill travel, the electric wheelchair may roll or skid. For this reason, avoid braking suddenly!

13.8 Travelling on hills, uphill and downhill travel

For your own safety you must observe and follow the following advice during uphill and downhill travel:

- › Set the seat position to its hindmost position in order to prevent slipping.
- › Always drive with your safety belt on.
- › Avoid braking suddenly during downhill travel to prevent the the electric wheelchair from rolling or skidding.
- › During uphill and downhill travel, select a low drive level and speed to prevent you from losing control of the electric wheelchair at any point.
- › The stability of the electric wheelchair cannot be guaranteed during uphill or downhill travel involving a slope of more than 7°; such travel will involve danger of the electric wheelchair tipping over.
- › When going downhill, the power generated is channelled into the accumulators. If the battery was fully charged on starting travel, the safety system switches to emergency stop, in order to prevent damage to the vehicle's electronic components through electrical overload. If this should occur, switch on an electrical device (e.g. the lights) to run down the battery, and then continue your journey.



During uphill and downhill travel, the brake release lever should be set to "**LOCK**". The motor brake only functions in "**LOCK**" position. Otherwise, the vehicle will travel downhill with no brake being applied.



See Section "13.10.1 Using the brake release lever (emergency release)"

13.9 The driving programmes / drive levels

The PARAVAN electric wheelchair has four different driving programmes, or drive levels. You can select the drive level you want or final driving speed of your electric wheelchair on the control panel.

You can reach the maximum final speed of the relevant drive level by pushing the joystick forward as far as it goes.

The functions of each of the drive levels are as follows:

- › Drive level 1
Highest level of control of the electric wheelchair
20% of final speed, for travelling around rooms.
- › Drive level 2
40% of final speed.
- › Drive level 3
60% of final speed.
- › Drive level 4
80% of final speed.
- › Drive level 5
For experienced drivers/users only
Maximum final speed.



See Section "16 Controls"

13.10 Driving manually, manual operation

13.10.1 Use of the brake release lever (emergency release)

> If you want to push the electric wheelchair, you must move both brake release levers ① on the left and right-hand side to "UNLOCK" (their downward position).

i Do not switch to "UNLOCK" on sloping surfaces! In this setting the drive motor has no braking function!

Settings on the brake release lever ①

LOCK

> Lever in its upward position
= drive, braking system active!

UNLOCK

> Lever in its downward position
= for pushing, braking system disabled!



Fig. 39: Brake release lever (emergency release)

13.11 Terrain requirements, surfaces

 WARNING
<p>Danger of tipping over for persons when using the electric wheelchair on surfaces with a slope of more than 10°.</p> <p>Danger of tipping over for persons when using the electric wheelchair on downhill slopes with the seat position in the most forward position.</p> <p>Danger of tipping over for persons when using the electric wheelchair when driving over obstacles.</p>
<ul style="list-style-type: none"> > Avoid paths with any inclination of more than 10°. > When travelling downhill move the electric wheelchair's seat towards the back. > Do not run over obstacles higher than 60 - 70 mm. > Always drive with your safety belt on.

13.11.1 Ability to ford, or drive through water

> Travel through water may lead to damage to electronic components (motors, control devices, etc.) and to accumulators due to water penetration.

13.11.2 Climbing and overtaking capacity

- › If you drive over obstacles higher than 60 to 70mm you and your electric wheelchair may become caught on the obstacle due to the battery casing and may be immobilised or overturn.

13.11.3 Load-bearing capacity

- › Do not drive on surfaces on which there is a danger that you may break through them and thus be come immobilised or overturn. Always consider the total weight of the vehicle.



See Section "22.1 Technical information and dimensions"

13.11.4 Impassible surfaces or areas

- › Driving on impassable surfaces or areas will risk the you and your electric wheelchair becoming immobilised or overturning.

13.11.5 Slippery surfaces, traction

- › Your electric wheelchair can lose grip when driving on slippery surfaces (e.g. unsurfaced ramps, wet grass, snow, ice, etc.). That means its drive and braking power are no longer effective.

In order to prevent damage to your electric wheelchair, you must observe the following rules when you park it, e.g. overnight, or for any longer period of time:

- › Connect it up with the recharger.
- › Select a dry parking position.
- › Do not expose your electric wheelchair to high or low temperatures.
- › Cover your electric wheelchair with a suitable covering.

14.1 Immobiliser/key function

Depending on the equipment of your electric wheelchair, there are two different ways of securing it from unauthorised use.



Secure your electric wheelchair from unauthorised use! You are responsible to ensure that your electric wheelchair is properly parked!

15. Loading and transporting your electric wheelchair

i Your electric wheelchair should always be switched off and properly secured or lashed down during transport. Use loading devices such as:

- › ramps, lifts and hoists

with sufficient load-bearing capacity.

15.1 Rules when loading wheelchairs

The following rules must be followed when loading:

- › The maximum rated height indicated on the ramp must be greater than the height to be climbed from the floor to the height of the supporting edge (in a car, for example, the floor of the car boot).
- › Check the load capacity of the ramp(s), of the life or of the hoist.
- › For safety reasons, your electric wheelchair should be loaded into a car or onto the necessary ramps only unoccupied (without any person or baggage on board).
- › The loading should be done only by persons familiar with the safe handling of your electric wheelchair.
- › Any electric wheelchair not designed for driving may only be loaded by your authorised specialist workshop. Only such persons know the possible hazardous situations and how to prevent them.

15.2 Securing your electric wheelchair, lashing

To prevent slippage, the electric wheelchair must be firmly secured or lashed to the transport vehicle using lashings, hooks or straps. The electric wheelchair must be secured in accordance with the

- › DIN 75078 (Parts 1 and 2) standard for powered vehicles in order for it to be conducted by persons with restricted mobility.

The electric wheelchair has the following lashing points.

- › Front: two rigging eyelets ①
- › Rear: one rigging eyelet ②

i No other securing is required if your vehicle is equipped with a PARAVAN docking station.

👉 See Section "5.4.2 Available accessories"

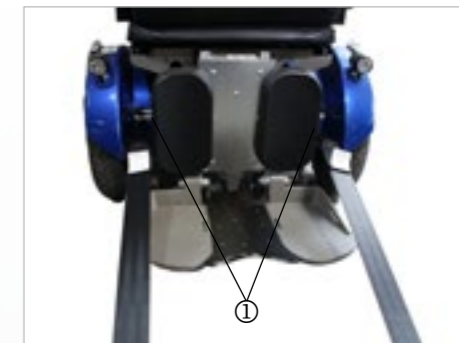

Fig. 40: Securing point at front



Fig. 41: Securing point at rear

15.3 Fasten the seatbelt in a moving vehicle

DANGER

Potential risk of injury or serious injury or death.

The Wheelchair integrated 3 or 4 point belts should not be relied on for occupant restraint in a moving vehicle. An approved, vehicle anchored safety belt system, should be used to secure occupant instead.

DANGER

Belt must not be held away from the body by wheelchair components such as armrests or wheels.

DANGER

Belt restraints should make full contact with the shoulder, chest and pelvic. Belts should be positioned low on the pelvis near the thigh-abdominal junction.

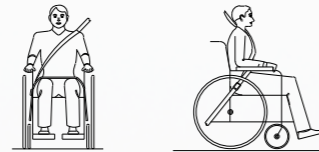

Fig. 42: Illustration of improper belt-restraint fit

Fig. 43: Illustration of proper belt-restraint fit

15.4 Securing the wheelchair with a 4 point strap restraint system

Standard ISO 10542-1 tie down straps are only tested to 85 kg + user.

It is recommended to use with 4 point strap restraint system rated for the total weight of the wheelchair including any option, 2 at front and 2 at the back that conforms to ISO 10542-1. If using a standard 4 point WTORS for securing a wheelchair heavier than 85 kg, use 6 straps to secure the wheelchair, 2 straps at the front and 4 straps at the back.

Recommended angel for tie down straps.

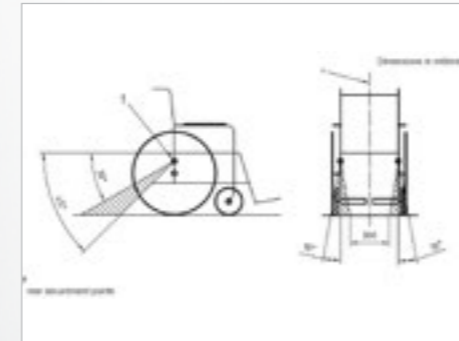

Fig. 44: Rear securement points

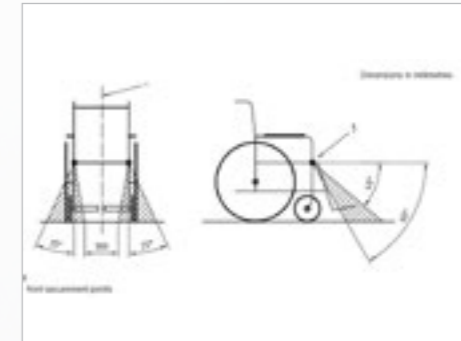

Fig. 45: Front securement points

15.5 Occupant restraint instruction

- › Use a vehicle anchored occupant restraint system to secure the occupant.
- › Both pelvic and upper torso restraint belts must be used to restrain the occupant to reduce the possibility of head and should not be held away from the body by wheelchair components such as armrest or wheels.
- › Restraints should be mounted to appropriate vehicle pillar and should not be held away from the body by wheelchair components such as armrest or wheels.



WARNING

Positioning the occupant restraint with 4 point strap system

- › Pelvic restraint belt must be worn low across the front of the pelvis so that the angle of the pelvic belt is within the preferred zone of 30° - 75° to the horizontal.

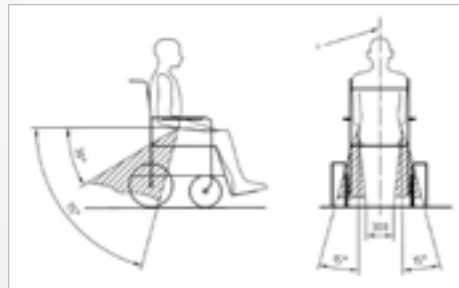

Fig. 46: Positioning the occupant restraint with 4 point strap system

- › The upper torso restraint belt must fit over the shoulder and across the chest as illustrated Fig. 47. Restraint belts must be adjusted as tightly as possible consistent with use comfort.
- › Restraint belt webbing must not be twisted when in use.
- › Care should be taken when applying the occupant restraint to position the seatbelt buckle so that the release button will not be contacted by wheelchair components during a crash.



WARNING

Positioning the occupant restraint for use with Dahl docking system only

- › When using wheelchair with Dahl docking system, the floor anchorage points for occupant restraint should be located 10 - 60 mm outside wheels, on each side. The pelvic belt must be worn low across the front of the pelvis - so that the angle of the pelvic belt is within the optional or preferred zone of 30° - 75°. As shown a steeper (greater) angle within the preferred zone, 45° - 75° is desirable i.e. closer to, but never exceeding 75° degrees.

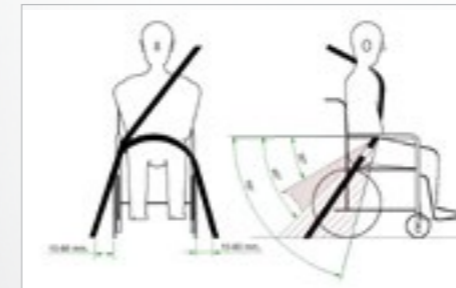

Fig. 47: Positioning the occupant restraint for use with dahl docking system only

15.6 Dahl Docking Systems Assembly

According to ISO 7176-19:2008, the Dahl Docking Station MK II and VarioDock™ are suitable for power wheelchair models PR50, PR Piccolino, PR Biolution and PR Heavy Duty from Paravan.

The following instructions explain how to assemble the Dahl Docking Station MK II and VarioDock™ on the wheelchair, using the PARAVAN adaption kit. Please also refer to Dahl Engineering's instructions for vehicle installation, use and maintenance.



Fig. 48: Dahl docking system



The operation of the electric wheelchair without faults or malfunctions can only be guaranteed if the knowledge gained from these assembly instructions is observed and implemented. PARAVAN GmbH assumes no liability or warranty for damage or operating faults resulting from non-compliance with these assembly instructions or from modifications to the electric wheelchair.



WARNING

Risk of injury through incorrect handling of the batteries.
Damage to property through incorrect handling of the batteries.

- > Handle with special care.
- > May only be connected and disconnected by qualified personnel.
- > Keep away from fire.
- > Dispose of damaged batteries properly.

15.6.1 Content of Dahl docking stations



Fig. 49: Content of Dahl Docking Station MK II standard set # 501750



Fig. 50: Content of Dahl VarioDock™ standard set # 503600

15.6.2 Fitting of the Dahl lock plate on wheelchair

In order to fit the Dahl Lock plate an additional wheelchair specific adaptation kit is required. It contains special nut and plastic spacers, which are to be fitted inside the battery box.

- ① Angle plate for Dahl system (PV-Art. Nr: 000033185)
- ② Side mounting for Dahl system (PV-Art. Nr: 000034091)
- ③ 8 mm intermediate piece for locking plate 10069 DAHL (PV-Art. Nr: 000010131)
- ④ Locking rail for Dahl-System (PV-Art. Nr: 000033184)
- ⑤ Oval-head screw ISO 7380 - M8 x 12
- ⑥ Socket cap screw DIN 912 - M12 X 20
- ⑦ Countersunk screw TORX ISO 14581 - M8 x 35 -14.9
- ⑧ Hexagon nut ISO 4032 - M8

- > To install the Dahl Locking plate use PARAVAN Adaption kit, article number 33187
- > To assemble the adapter set of the Dahl docking station, you need two Allen keys, size 5 and size 10, a Torx 27 and a wrench SW 13.
- > Tighten the Torx screws to a torque of 16-18 Nm.
- > The panelling must first be removed in order to mount the Dahl docking station to the Paravan wheelchair.

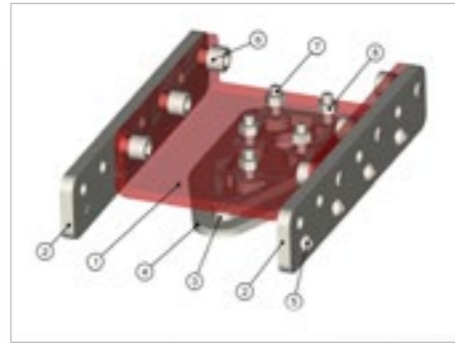

Fig. 51: Paravan Kit for Dahl docking station



Fig. 52: Torx 27

- > To remove the cover, loosen all four knurled screws ①.
- > Remove the rear panel ② first, then the side panels ③.
- > Disconnect the main cable plug from the batteries left and right ④.

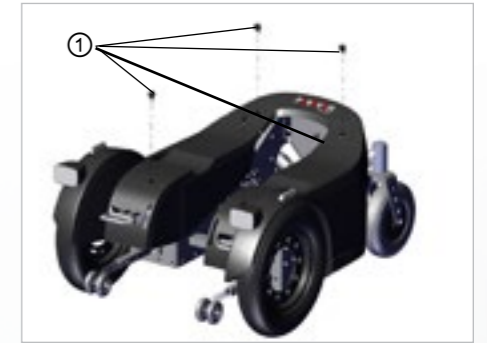

Fig. 53: Knurled screws Paravan



Fig. 54: Main Cable battery



Fig. 55: Disconnect battery

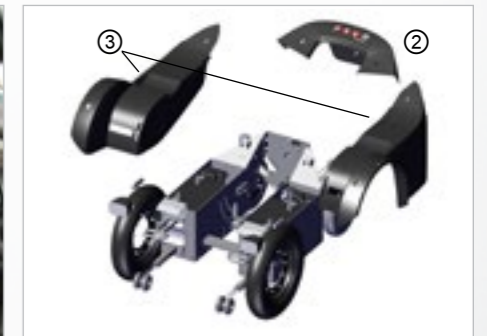

Fig. 56: Rear and side panels Paravan

- › Then remove the left and right batteries.
- › Position the Dahl system on the wheelchair chassis.
- › Fasten the Dahl system on both sides with four M8 x 12 pan-head screws each.
- › Screw them in medium-tight with a screw lock



Fig. 57: Remove batteries Paravan

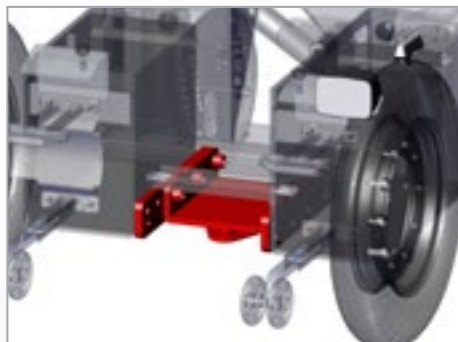

Fig. 58: Position the Dahl system

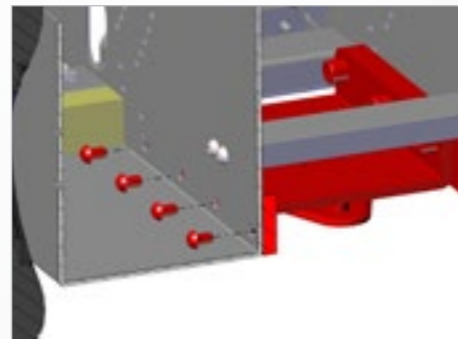

Fig. 59: Fasten the Dahl system

After the Dahl system has been attached to the wheelchair chassis, reinsert the batteries and reattach the panelling in reverse order.



The PARAVAN adapter kit can also be pushed further forwards or backwards and fastened accordingly, depending on the position of the counterpart in the vehicle.



Installation of the Dahl Docking systems in the vehicle: Only professional companies in the business of converting or building wheelchair accessible vehicles can order the docking system from Dahl Engineering. A qualified and experienced technician must carry out the installation. Dahl Engineering can provide vehicle specific installation instructions for a large range of vehicles, which must be respected by the fitter. Please contact Dahl Engineering for further information about approved vehicles and fitting positions.

To attach the Dahl Docking Station to the PR piccolino, use the screws provided.



	DANGER
Potential risk of injury or serious injury or death due to use of incorrect screws.	
<ul style="list-style-type: none"> > Use the screws provided. > Do not use any other screws than those supplied from Dahl Engineering (part no. 502800 which is quality 14.9 with torx 27 key). Standard screws will not be strong enough in the event of a collision. 	

15.6.3 Description of the Dahl Docking system functions

- ① Dahl Docking station
- ② Lock plate and spacer
- ③ Lock pin
- ④ Red LED
- ⑤ Green LED
- ⑥ Control panel
- ⑦ Release button
- ⑧ Manual emergency release lever
- ⑨ Manual operating lever



Please refer to Dahl Engineering's installation and user guide for height adjustable VarioDock™ system.

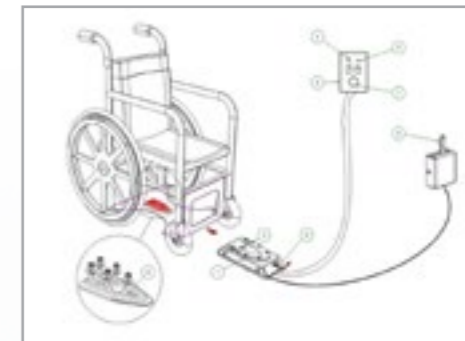



Fig. 60: System functions Dahl

15.6.4 Securing the wheelchair in the docking station

- › Maneuver the wheelchair slowly and in a uniform direction over the docking station. The lock plate under the wheelchair helps to guide the wheelchair into place in the docking station. When the lock plate is fully engaged in the docking station, a spring-action locking pin automatically secures the lock plate.
- › The docking station is equipped with a control switch that indicates whether the lock plate is correctly secured in the docking station. As soon as the lock plate comes into contact with the locking pin, a warning tone will sound (a high-pitched howl), and the red diode/lamp (LED) in the control panel will light up until the lock plate is either fully engaged or else the wheelchair is removed from the docking station.
- › As an indication that the wheelchair is properly secured, the warning tone will cease, the red lamp (LED) in the control panel will go out and the green lamp (LED) will light up.
- › Do not forget to buckle up for driving.



Please refer to Dahl Engineerings installation and user guide for height adjustable VarioDock™ system.

 DANGER
<p>Potential risk of injury or serious injury or death! Do not move the vehicle:</p> <ul style="list-style-type: none"> › Whilst the wheelchair is being maneuvered into position in the docking station › If the wheelchair and user are not correctly secured. › If the warning tone sounds and/or the red warning lamp (LED) in the control panel flashes or is lit! <p>Always check if the lock plate is properly engaged in the docking station by trying to reverse the wheel chair out of the docking station before moving the vehicle. (It must not be possible to reverse out of the docking station without pressing the red release button in the control panel).</p>

15.6.5 Release from the docking station

- › When the vehicle has been brought to a halt, remove the safety belt.
- › To unlock commence by driving the wheelchair forward to release pressure on the lock pin.
- › Press the red release button in the control panel. The locking pin will be triggered/ released for approx. 5 or 8 seconds, after which the locking pin is automatically locked/activated again.
- › Move the wheelchair away from the docking station within this 5 or 8 second period. Do not attempt to reverse out of the docking station until the red LED on the control module, which indicates the unlock position, has been illuminated.



Please refer to Dahl Engineerings installation and user guide for height adjustable VarioDock™ system.



WARNING

Attempting to reverse the wheelchair before the red LED has been illuminated will result in blocking the docking stations locking mechanism, which makes it impossible to reverse. If this happens repeat above unlocking procedure.

15.6.6 Manual release in case of electric failure

A manual emergency release is located at the front edge of the docking station.

- › Move wheelchair forward to remove the pressure on the lock pin and push the red release arm to one side and hold it there while the wheelchair moves away.
- › A cable-activated manual operating lever can also be fitted (accessory). The red release arm is also pushed to one side and should be held there whilst the wheelchair moves away.

If the described manual release procedures fails, an emergency release tool made from red plastic comes with each docking station.

- › Move wheelchair forward to remove the pressure on the lock pin
- › Place the emergency release tool in the gap between the locking plate and the docking station.
- › Push the release tool and wheelchair forward until the locking pin has been forced down - after which the wheelchair can reverse out of the docking station.
- › Please also refer to Dahl Engineering instructions for installation, use and maintenance for Dahl Docking Station MK II and VarioDock™ systems.



Fig. 61: Manual release step 1



Fig. 62: Manual release step 2

16. Controls

16.1 Control panel R-NET CJSM2

16.1.1 Overview of the control elements



Fig. 63: Control panel R-NET CJSM2

With the control panel (joystick) built into your power wheelchair, you can control all of the power wheelchair's driving, steering and braking processes. All additional functions which are equipped with displacement motors, such as the lifting arm and the sitting functions, must also be operated via the control panel.

- > "On/off" key ①
- Selection of profile (movement levels)/mode (seat functions)
- > "Direction indicator, right/left" keys ②
- > LCD diagnostic LED brightness sensor ③
- > Display ④ (colour)
- > MODE key ⑤ for switching function – drive program/seat functions
- > PROFILE key ⑥ (selection of movement levels)
- > Joystick ⑦ (determines direction of travel)
- > "Horn" key ⑧
- > Function key ⑨ for selecting/drilling down to movement levels
- > "Hazard lights" key ⑩
- > "Light" key ⑪
- > Charging status indicator for storage battery ⑫

16.1.2 Status display

The function keys are used to select the specific functions displayed in the assigned fields on the display.

Symbols of the status indicator:

- > Charging status of the storage batteries ①
- > Direction indicator, left ②
- > "On/off" light ③
- > System status ④ ("tortoise" → speed control active)
- > Direction indicator, right ⑤
- > Time ⑥
- > Hazard lights "on/off" ⑦
- > Current seat function ⑧



Symbols ② + ⑤ play an active part in the "hazard lights" function!



Fig. 64: Function keys

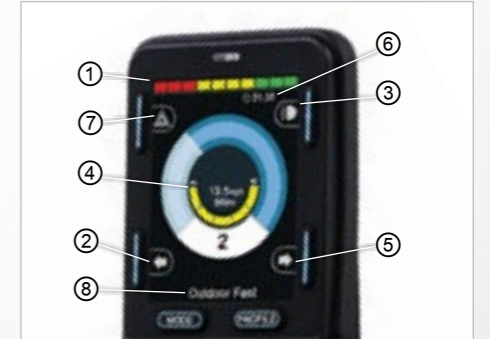

Fig. 65: Status display

16.1.3 Start, switch off



Fig. 66: "On / off" key

Start

Push the "on/off" switch ① upwards.

- > The status display briefly flashes and the last selected function in terms of movement level/seat function is shown.
- > Press the switch ① downwards again to:
 - Select movement levels 1 to 5.
 - Then switch to the seat functions.

Switch off

Push the "on/off" switch ① upwards.

- > The power wheelchair switches itself off (assuming it is already switched on).

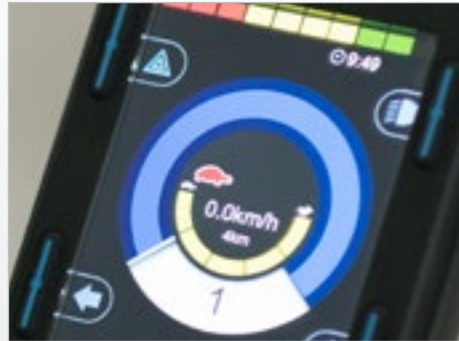

Fig. 67: Speed control (tortoise) active

16.1.5 Switch direction indicator on and off

Press key ① or ② for the respective direction indicator, left or right.

- > The selected direction indicator will flash.
- > Press once more → direction indicator switches off.



Fig. 70: Turn signal right / left

16.1.4 Switch light on and off

Press the key ① for the "light on" function.

The lighting installation switches itself on and the light symbol lights up blue.

Press once more:
→ Light off



Fig. 69: Light on and off



Fig. 68: Light symbol (colour)

16.1.6 Switch hazard lights on and off

Press the “hazard lights” key ① for the “hazard lights on” function.

- > The hazard lights switch themselves on, while the hazard lights symbol flashes red and both direction of travel symbols flash green.
- > Press the key again → the hazard lights/hazard lights symbol switch themselves off.



Fig. 72: Hazard lights on / off

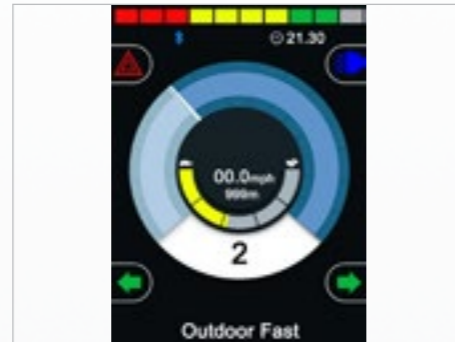

Fig. 71: Symbols (colour)

16.1.7 Driving functions overview



Fig. 73: Driving functions

Overview of the driving functions shown on the display of the control panel during driving, steering and braking actions of the power wheelchair.

- > Selected drive program/movement level ①
- > Respective setting (having drilled down) for the selected movement level (1 to 5) Maximum speed in the selected drive program ②
- > Key ③ (Profile) to switch to a higher or lower drive program (1 to 5)
- > Key ④ to change speed in the drive program
- > Display of the current speed (km/h) ⑤
- > “Trip” display in kilometres ⑥

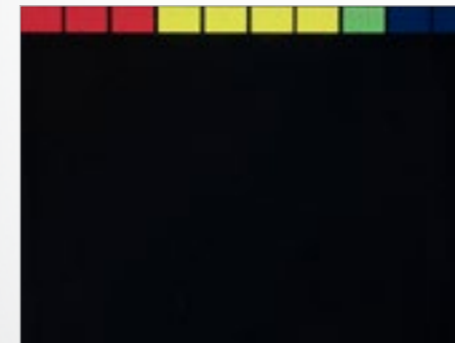

Fig. 74: Charging status indicator (driving function blocked)

Display turns black when a charging device is connected.

- > If the wheelchair is switched on, the charging status indicator is the only thing shown.
- > First connect the charging lead for the charging device at the joystick, then plug the power cable for the charging device into the socket.



If the power wheelchair is being charged via the charging socket on the control panel, driving mode is automatically blocked.

16.1.8 Select drive program, drive

The power wheelchair must be in driving mode.

- > The last selected drive program is shown on the display (profiles 1 to 5). Drive profiles 1 to 5 are further divided into 5 levels once you drill down.

Press the switch upwards ① or downwards ② to switch to a higher or lower sub-level.

- > The selected drive program and sub-level will appear on the display.

Push the joystick in the direction in which you wish to travel.

- > The power wheelchair moves in the selected direction.
 - ① Move forwards
 - ② Turn to the right
 - ③ Move backwards
 - ④ Turn to the left

 See section "3 Safety notes"



Fig. 75: Select drive program



Fig. 76: Joystick travelling direction

16.1.9 Electrical seat adjustment



Fig. 77: Display of seat functions

Use the MODE key to switch from the drive program to the seat functions. Select the desired seat function by moving the joystick "← left/right →".

- > The adjustment functions menu will appear on the display.

 Only the released or available functions can be selected.

To make the desired setting: adjust the seat, seat position, lifting of seat, backrest, tilting of seat, angle for legs, legroom or electric footrest via the joystick (by moving it forwards or backwards).

Switch back to the drive program with the profile key.

- > The power wheelchair is ready to drive.

 See section "3 Safety notes"

16.1.10 Set time/date

Press and hold the “hazard lights” key to access the “Settings” menu.

> The special functions menu will appear on the display.

Move the joystick → left/right to access the options “year, month, date, day of the week, hours and minutes”. Select the desired option by moving the joystick “← left/right →”.

Move the joystick “↑ up/down ↓” to select exactly the setting you want. To save and quit the menu, go to “Quit” and close it by moving the joystick “↑ up/down ↓”.

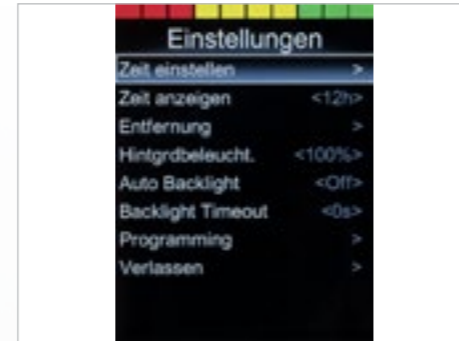

Fig. 78: “Set time” function menu



Fig. 79: Setting the time and date

16.1.11 Show/hide clock, configure 12h/24h display

Select the program function:

- > Press and hold the “hazard lights” key.
- > The “Settings” menu appears.
- > Use the joystick to select “Set time”. Move the joystick “← left/right →”.
- > Select “12h/24h display” or “Off” by moving the joystick “← left/right →”.
- > To save → quit the program. Move the joystick “← left/right →”.



Fig. 80: Set clock to visible/invisible

16.1.13 Adjust display brightness

Select the program function:

- > Press and hold the "hazard lights" key.
- > Select "Back lighting" from the settings.
- > Select the intensity of the lighting (0 to 100% in 10% stages) by moving the joystick "← left/right→".
- > To save → quit the menu.



Fig. 82: Setting the display brightness

16.1.12 Adjust display brightness, automatic



The display brightness is automatically adjusted to lighting conditions by the factory. Menus may be arranged slightly differently, depending on the software version.

Select the program function:

- > Press and hold the "hazard lights" key.
- > Select "Auto Backlight" from the settings.
- > Select "On/Off" by moving the joystick "← left/right→".
- > To save, quit the menu.

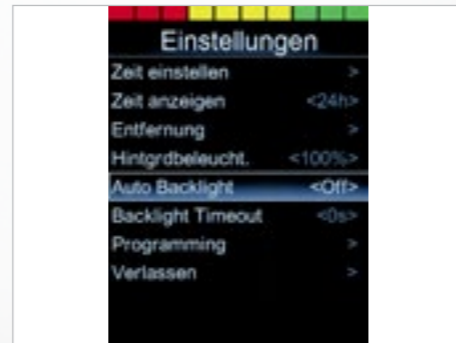

Fig. 81: Autom. display brightness

16.1.14 Block the controls (with the wheelchair switched on)

- > Straight after pressing the "on/off" key ① (for switching the wheelchair off), move the joystick "backwards" → "forwards" → "backwards" at short intervals (wait for a short beeping signal each time) → then release the joystick.
- > A longer beeping signal confirms the controls have been blocked.



Fig. 84: Turn signal right / left

16.1.15 Release the controls (with the wheelchair switched off)

- > Switch on → and a "padlock symbol" appears .
- > Now straight away move the joystick "forwards" → "backwards" (wait for a beeping signal each time).
- > A longer beeping sound confirms the controls have been released.
- > → Release the joystick → joystick in initial position (longer beeping signal confirms the controls have been released).
- > The "Functions" menu is now available – the last function selected is shown.



Fig. 83: Lock symbol

16.2 Control panel R-NET CJSM-L

16.2.1 Overview of the control elements



Fig. 85: Control panel R-NET CJSM-L

With the control panel (joystick) built into your power wheelchair, you can control all of the power wheelchair's driving, steering and braking processes. All additional functions which are equipped with displacement motors, such as the lifting arm and the sitting functions, must also be operated via the control panel.

- > "On/off" key ①
- > "Direction indicator, right/left" keys ②
- > Display showing the signal currently active (light, indicator) ③
- > Display ④ (colour)
- > MODE key ⑤ for switching function – drive program/seat function
- > PROFILE key ⑥ (selection of movement levels)
- > Joystick ⑦
- > "Horn" key ⑧
- > Function key ⑨ for selecting/drilling down to movement levels
- > "Hazard lights" key ⑩
- > "Light" key ⑪
- > Charging status indicator for storage battery ⑫

16.2.2 Status display

The function keys are used to select the specific functions displayed in the assigned fields on the display.

Symbols of the status indicator:

- > Charging status of the storage batteries ①
- > Direction indicator, left ②
- > "On" light ③
- > System status ④ ("tortoise" → speed control)
- > Direction indicator, right ⑤
- > Time ⑥
- > Hazard lights ⑦



Symbols ② + ⑤ play an active part in the "hazard lights" function!



Fig. 86: Function keys



Fig. 87: Status display

16.2.3 Start and switch off



Fig. 88: "On / off" key

Start

Push the "on/off" switch ①.

- > The last selected function in terms of movement level/seat function is shown.

Switch off

Push the "on/off" switch ①.

- > The power wheelchair switches itself off (assuming it is already switched on).



Fig. 89: Speed control (tortoise) active

16.2.5 Switch direction indicator on and off

Press key ① or ② for the respective direction indicator, left or right.

- > The selected direction indicator will flash.
- > Press once more → direction indicator switches off.



Fig. 92: Turn signal right / left

16.2.4 Switch light on and off

Press the key ① for the "light on" function.

The lighting installation switches itself on and the light symbol lights up blue. Press once more: "light off".



Fig. 91: Light on and off



Fig. 90: Light symbol (colour)

16.2.6 Switch hazard lights on and off

Press the “hazard lights” key ① for the “hazard lights on” function.

- > The hazard lights switch themselves on, while the hazard lights symbol flashes red and both direction of travel symbols flash yellow.
- > Press the key again → the hazard lights/hazard lights symbol switch themselves off.



Fig. 94: Hazard lights on / off



Fig. 93: Symbols (colour)

16.2.7 Driving functions overview

Overview of the driving functions shown on the display of the control panel during driving, steering and braking actions of the power wheelchair.



Fig. 95: Driving functions

- > Selected drive program/movement level ①
- > Maximum speed in the selected drive program ②
- > Key ③ to switch to a higher (+) or lower (-) drive program
- > Key ④ to change speed in the drive program
- > Display showing “trip” in kilometres and current speed (km/h) ⑤



Fig. 96: Driving function blocked

Display is blank when a charging device is connected.

- > If the wheelchair is switched on, the charging status indicator is the only thing shown.
- > First connect the charging lead for the charging device at the joystick, then plug the power cable for the charging device into the socket.



If the power wheelchair is being charged via the charging socket on the control panel, driving mode is automatically blocked.

16.2.8 Select drive program, drive

The power wheelchair must be in driving mode.

- > The last selected drive program is shown on the display.

Press the profile key ① to select/switch to one of the 5 movement levels (profiles).

- > The selected drive profile will appear on the display.

Press the relevant key to select a higher ② or lower ③ maximum end speed in the respective drive profile.

- > The preference within the drive profile will appear on the display.

Push the joystick in the direction in which you wish to travel.

- > The power wheelchair moves in the selected direction.

- ① Move forwards
- ② Turn to the right
- ③ Move backwards
- ④ Turn to the left

 See section "3 Safety notes"



Fig. 97: Select drive program



Fig. 98: Joystick travelling direction

16.2.9 Electrical seat adjustment

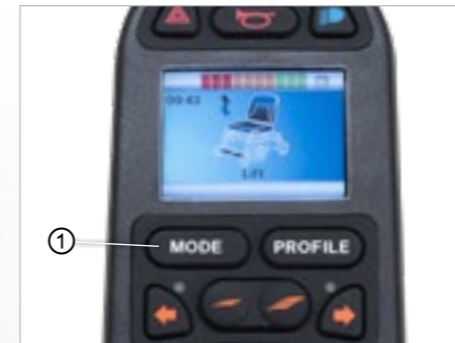



Fig. 99: Display of seat functions

Use the "Mode key" to switch from the drive program to the seat functions. Select the seat function by moving the joystick "← left/right →".

- > The respective seat function will appear on the display.

 Only the released or available functions can be selected.

Adjust the seat via the joystick (push forwards or backwards).

- > The seat carries out the desired function.

Switch back to the drive program with the mode key.

- > The power wheelchair is ready to drive.

 See section "3 Safety notes"

16.2.10 Set time/date

Press and hold the “slower” ① and “faster” ② speed keys to access the “Settings” menu.

- › The special functions menu will appear on the display.
- Move the joystick → right to access the options “year, month, date, day of the week, hours and minutes”. Select the desired option by moving the joystick “← left/right →”.
- Move the joystick “↑ up/down ↓” to select exactly the setting you want. To save and quit the menu, go to “Quit” and close it by moving the joystick “↑ up/down ↓”.



Fig. 100: “Set time” function menu



Fig. 101: Setting the time and date

16.2.11 Show/hide clock, configure 12h/24h display

Select the program function:

- › Press and hold the keys ①+②.
- › The “Settings” menu appears.
- › Use the joystick to select “Display time”.
- › Select “12h/24h display” or “Off” by moving the joystick “← left/right →”.
- › To save → quit the program.



Fig. 102: Set clock to visible/invisible

16.2.13 Adjust display brightness

Select the program function:

- > Press and hold the “slower” ① and “faster” ② speed keys.
- > Select “Back lighting” from the settings.
- > Select the intensity of the lighting (as a percentage) by moving the joystick “← left/right→”.
- > To save → quit the menu.



Fig. 104: Setting the display brightness

16.2.12 Adjust the display background and brightness

Select the program function:

- > Press and hold the “slower” ① and “faster” ② speed keys.
- > Select the preferred option by moving the joystick “← left/right→”.
- > To save, quit the menu.



Fig. 103: Setting the display background

16.2.14 Block the controls (with the wheelchair switched on)

- > Press and hold the “off key” ① to switch the wheelchair off.
- > Now straight away and in quick succession (wait for a beeping sound each time), move the joystick ② “backwards” → “forwards” → “backwards” → then release the joystick.
- > A longer beeping sound confirms the controls have been blocked.



Fig. 106: Blocking the controls

16.2.15 Release the controls (with the wheelchair switched off)

- > Switch on → and a “padlock symbol” appears .
- > Now straight away move the joystick (wait for the confirmation sound each time) “forwards” → “backwards” → then release the joystick.
- > A longer beeping sound confirms the controls have been released.
- > The “Functions” menu is now available – the last function selected is shown.



Fig. 105: Controls blocked – block symbol

17. Getting out of your electric wheelchair

When getting out of your wheelchair independently, you should keep in mind the following points for your own safety:

- › You should be able to deal with your own body weight safely.
- › You should be able to push against the electric wheelchair with both arms simultaneously and with each exerting equal strength.
- › You should have a secure point against which you can lean and out of which you cannot slip.
- › You should have practised the manoeuvre often enough in the presence of another person.
- › You should consider what could happen if you were to fall to the floor without anyone being there to help you.

i We recommend allowing another person to help you. You should, however, inform this person of the risks involved. Always fully discuss the procedure for the move. Never support yourself against the drive control, as the electric wheelchair may be activated accidentally and may make uncontrolled movements.

i If you want to move onto another electric wheelchair, you must set the brake release lever to "LOCK" (in its uppermost position) and the electric wheelchair must be switched off.

👉 See Section "13.10.1 Using the brake release lever (emergency release)"

17.1 Procedure when getting out from the side

During any move from the side, follow this sequence of actions:

- › Position the electric wheelchair side on
- › Set the required seat height
- › Switch the electric wheelchair off
- › Fold the foot rests ① up
- › Swing armrest ② upwards
- › Move



Fig. 107: Move, foot rests

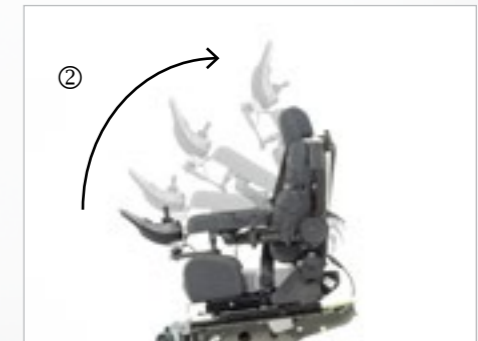

Fig. 108: Move, armrest

18. Care and maintenance

Appropriate use and operation of the PARAVAN electric wheelchair involves subjecting it to the recommended annual maintenance plan. All powered parts, and particularly the lift arm, are structurally designed so that to ensure that electric wheelchair can be operated without failures and requiring little maintenance.

However, the following considerations should be kept in mind to ensure problem-free functioning:

- › It should be handled with care
- › It should be kept clean
- › It should be serviced annually.

18.1 Service partners

Where problems should arise, please get in touch with your medical supplies store or dealer, or contact PARAVAN GmbH directly.

 See Section "1.1 Your manufacturer"

 For execution of maintenance work, please get in touch with your medical supplies store or dealer, or contact PARAVAN GmbH directly. Maintenance and repair work should only be done by suitably trained personnel.

18.2 Cleaning and care

 High-pressure cleaners should not be used to clean the electric wheelchair. Be careful that no electronics come in contact with water.

Only the following should be used for cleaning the frame and plastic components (or painted layer)

- › Mild soaps containing no scouring additives.

For disinfection of covers, the seat and back cover

- › conventional surface disinfectants and
- › damp micro-fibre cloths

should be used.

19. Disposal and environmental protection

The electric wheelchair itself and its individual components are designed to enjoy a long service life. During manufacture and construction, care was taken to use recyclable and harmless raw materials as much as possible. At the end of its service life, the electric wheelchair is suitable for careful recycling and environmentally friendly disposal.

i National and regional regulations on the disposal of waste should be followed.

For the purposes of recycling, the electric wheelchair can be dismantled into following principal materials:

- › Metals
- › Plastics and composite materials
- › Electronic waste
- › Accumulators.

An effort should be made to achieve a high-level of recycling appropriate to the type and nature of the waste material (according to German law life-cycle management of waste materials). The recycling process is considered economically feasible if the costs associated with the process are not out of proportion to the costs that would be incurred by disposal of the waste.

19.1 Packaging materials

The packaging is largely made of recyclable and environmentally harmless materials, such as:

- › Wood; e.g. pallets and outer packaging
- › Metal; e.g. tensioning straps
- › Bubble wrap

i Take advantage of the opportunity to recycle the packaging in an environmentally friendly manner. Recycling of waste is preferable to disposing of it.

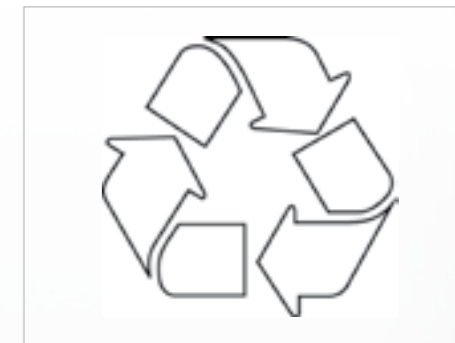

Fig. 109: Recycling

19.2 Re-commissioning

If the electric wheelchair has been out of use for an extended period, the following steps should be taken before putting it back into use:

- › Check all safety devices and repair them where necessary
- › Undertake a complete service and revision
- › Clean thoroughly.



The electric wheelchair must be completely cleaned and subjected to a thorough inspection by a service technician authorised by PARAVAN GmbH before being put back into use.



See Section "18 Care and maintenance"

19.3 Notes on transfer

Where the PARAVAN electric wheelchair is transferred to new user, all technical documentation required for safe use and operation, such as;

- › The User's Manual and
- › Service logs

must be passed on to the new user.



See Section "18 Care and maintenance"

20. Correcting failures

20.1 Flashing codes indicating the status of the control panel

Flashing code	Meaning	Immediate action	Further action
Flashing once	Defective module.	-	Speak with specialist dealer
Flashing twice	An accessory has failed.	-	Speak with specialist dealer
	Lifter extended	Lower lifter fully	-
Flashing three times	Failure in right-hand motor. Loose connection or defective, or motor defective.	Check plug connection	Speak with specialist dealer
Flashing four times	Failure in left-hand motor. Loose connection or defective, or motor defective.	Check plug connection	Speak with specialist dealer
Flashing five times	Failure or braking failure in left-hand motor. Loose connection or defective, or motor defective.	Check plug connection	Speak with specialist dealer

Flashing code	Meaning	Immediate action	Further action
Flashing six times	Failure or braking failure in left-hand motor. Loose connection or defective, or motor defective.	Check plug connection	Speak with specialist dealer
	Motors disconnected.	Connect motors. Switch control panel off and back on again	-
Flashing seven times	Accumulator completely empty.	Recharge accumulator	Speak with specialist dealer
Flashing eight times	Voltage of batteries too high.	-	Speak with specialist dealer
Flashing 9 or 10 times	Faulty data transfer between modules.	-	Speak with specialist dealer
Flashing 11 times	Motor overloaded.	Switch control panel off and back on again	Speak with specialist dealer
Flashing 12 times	Compatibility problem between modules.	-	Speak with specialist dealer

21. Electrical system

21.1 Automatic safety switches

The PARAVAN electric wheelchair is equipped with two automatically triggered safety switches and an electrical overload protection mechanism. Taken individually, they may be described as follows:

› **Main safety switch**

The main switch protects the electric wheelchair's entire electrical system from any overload of electrical devices by activating immediately to cut off electricity from your electric wheelchair.

☞ See Section "21.2 Main safety switch"

› **Secondary safety switch**

This protects all other electric devices and ancillary devices, such as breathing apparatuses.

☞ See Section "21.3 Secondary safety switch"

› **Protection against overload**

When you are travelling downhill the power generated is channelled into the accumulators. Where the accumulators are already charged, then the safety system switches to emergency stop.

☞ See Section "21.4 Protection against overload"

21.2 The main safety switch



The main safety switch is positioned at the rear of the electric wheelchair on the left. A pivoted green flag indicates that the main safety switch has been activated (triggered).

21.2.1 Resetting the main safety switch

- › Push the flag ① indicating that the mains switch has been activated ② back into its original position ③. You should be able to hear and feel it click back into place.
- › The electric wheelchair is now ready for use once more.



Fig. 110: Main safety switch, activ



Fig. 111: Main safety switch

21.3 The secondary safety switch





-  The secondary safety switch can be found on the left under the electric wheelchair's cladding.
-  A raised button ① indicates that the secondary safety switch has activated.

Fig. 112: Sec. safety switch, activ.



21.3.1 Resetting the secondary safety switch



- › Remove cladding.
-  See Section "12 Removing and reattaching the chassis cladding"
- › Press the safety button ② in.
- › Reattach cladding.
- › The electric wheelchair is now ready for use once more.

Fig. 113: Secondary safety switch

21.4 Overload protection

-  The electricity generated when travelling downhill (when the drive motors act as dynamos) is directed into the accumulators. If you have fully recharged your electric wheelchair before starting the downhill stretch the safety system switches to emergency stop in order to prevent damage to the electrical system (control, electronics, etc.).
-  If the overload protection feature is activated (triggered) then this will be indicated by a slow braking of the electric wheelchair until it stops moving.

21.4.1 Resetting the overload protection:

- › Switch on an electrical device, such as your lighting. The excess electric power will then be quickly consumed.
- › The electric wheelchair is now ready for use once more.

21.5 Facility to connect ancillary devices



The PARAVAN electric wheelchair provides the facility to connect a variety of ancillary devices with a voltage of 12 or 24 volts to the electric wheelchair's own on-board network.

If you have a need for this facility – for example for a breathing apparatus, please contact PARAVAN GmbH. The external connections will be made to suit the needs of the affected user and the cable loop will be cut or relayed as necessary.



See Section "1.1 Your manufacturer"

21.6 The lighting system

Depending on the variant you have chosen, your PARAVAN electric wheelchair may be equipped with a complete set of road-approved lighting using LED technology. The use of LED lamps means that lamp replacement or maintenance tasks are practically no longer necessary. If your electric wheelchair was delivered to you without a lighting system, you can retrofit the system at any time.

Take the following steps in the following sequence when switching on the lighting system:

- > Select the menu in the control.
- > Switch on the lighting.



See Section "16 Controls"

Components of the lighting system:

- > LED front headlight ①
- > LED directional indicator ②
- > LED tail light ③



Fig. 114: Front illumination



Fig. 115: Rear illumination

21.7 The maintenance-free accumulators

Your PARAVAN electric wheelchair is fitted with high-quality, high-performance accumulators. These maintenance-free accumulators are entirely enclosed. The system is not designed to need or allow any refilling or topping up the electrolyte (battery acid).

The state of charge or capacity of the accumulators can be seen from the control panel.

- › **Red zone**
Low capacity, must be recharged immediately.
- › **Yellow zone**
Sufficient energy still available, recharge as soon as the opportunity arises.
- › **Green zone**
Accumulator fully loaded, full capacity.

 See Section "16 Controls"

 See Section "21.10 Charging the electric wheelchair"

21.8 Notes on accumulators

 The enclosed accumulators should never be opened. Opening the accumulators will cause irreparable damage to these components, possibly resulting in a complete loss of energy supply.

 See Section "23.1 Dealing with closed accumulators"

 The accumulators should always be recharged using the supplied recharging device after every spell of use (even if use of charge was minimal during the spell). Always connect the recharger when the electric wheelchair is not in use. The recharger supplied switches automatically to "maintain charge", thus guaranteeing you that your accumulators in your electric wheelchair will always be ready for use and fully charged. If the accumulators are left in an uncharged state for too long they will become deeply discharged and will no longer be capable of recharging and/or will need to be replaced.

 See Section "21.10.2 The charging device"

 Observe the relevant regulations on waste disposal when disposing of the accumulators. Please consult the local or municipal authorities responsible for this issue or talk directly to a waste disposal company.

 See Section "19 Disposal and environmental protection"

21.9 Changing your accumulators



Fig. 116: Power connection



If it should become necessary to replace the accumulators in your electric wheelchair, let your service technician or dealer do the work in order to guarantee the safe function of your electric wheelchair.

- › Move the lift arm upwards.
- › Remove cladding.



See Section "12 Removing and reattaching the chassis cladding"



Fig. 117: Refitting, accumulator

- › Disconnect power connection ①.
- › Disassemble the accumulators: Remove the accumulators from the battery casing using the hand straps provided.
- › Transfer the remaining part of the power connection ② onto the new accumulator.
- › Place the new accumulator in the battery casing.
- › Reconnect the power connection ①.
- › Re-attach cladding.
- › Execute a functional check.

21.10 Charging your electric wheelchair



Charge the accumulators only with the charging device supplied. The recharging device is available in 2 models:

- › "Indoor" for use in indoor areas
- › "Outdoor" for use outdoors

Care tips:

- › Make sure that the accumulators are always charged to full capacity.
- › The best way to do this is to recharge nightly.
- › The charging time for your electric wheelchair should be 8 hours without any interruption.
- › The charging cycle is complete when the green lamp lights up.
- › Always keep your electric wheelchair connected to the recharging device when not in use (to maintain its charge).



If you follow these care tips, your accumulator will provide you with the highest possible performance and longest possible service life.



See Section "21.7 The maintenance-free accumulators"



See Section "21.8 Notes on accumulators"

21.10.1 Procedure for charging your electric wheelchair



Fig. 118: Plug in the charging cable

- > Switch electric wheelchair off.
- > Place the charging device on a heat-resistant surface e.g. the foot supports.
- > Insert the charging device plug ① into the charging socket on the control panel.
- > Connect the charging device to the mains supply → charging has started.
- > Check the charging status → has it reached full capacity? The recharging process is now complete.
- > Dismantle the recharging device in the opposite sequence.

i After completing charging, undo the connection between the mains supply at the mains plug from the charging device.

LED-Functions

- Yellow LED illuminated: The battery-charger loads in the main loading phase
- Yellow and first green LED illuminated: The battery charges one hour in the post charging phase
- First green LED illuminated: Maintenance charging

i The wheelchair must be charged a minimal of a full 12 hours per week.

21.10.2 The charging device

The charging device is suitable for automatic charging of the accumulators. The charging device is protected by a water-resistant sheet-steel housing. This complies with the directives and safety regulations of:

- > 2006/95/EC Low Voltage Directive
- > 2004/108/EC Electromagnetic Compatibility Directive

i Read the Users' Manual packed separately with the charging device.

21.10.3 Positioning the charging device

- > Use only in dry areas.
- > Do not cover any openings on the housing.
- > Ensure adequate ventilation.
- > Do not place in the vicinity of devices giving off heat radiation (e.g. under lamps, beside heating, etc.)

i During charging position the charging device on the foot supports of the wheelchair.

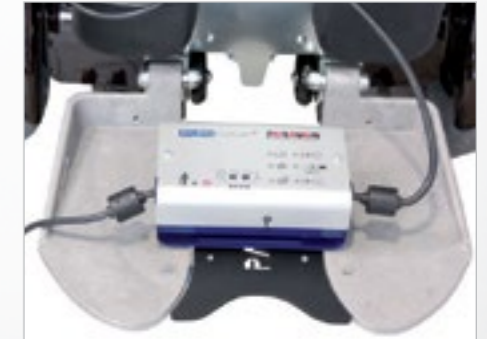

Fig. 119: Pos. the charging device

22. Technical equipment

22.1 Technical data and dimensions

Orthopaedic seat K630 seating unit	
Lifting function as measured without seat	360mm - 800mm
Tilting	Forward 21° Backward 50°
Back angle	Backward 67°
Side frame repositioning	Thoracic area 30mm / side Seat area 50mm / side
Lumbar support, 4 levels	Height adjustment 70mm Curvature 0mm - 25mm
Adjustment of foot position	120mm
Seat length adjustment, optional	180mm
Foot angle adjustment, optional	0° - 90°
Electric foot rest, optional	0° - 90°
Head support	5 positions
Armrest	6 axes with 12 individual adjustments
Weights	
Empty weight including accumulators, without seat	133kg
Maximum load	160kg

Dimensions	
Total width of chassis without seat (Standard seat fully within the chassis width)	640mm
Total length without foot rests, forward movement.	990mm
Total length without foot rests, reverse movement.	900mm
Total height, standard seat, including head support	1240mm
Total height, standard seat, without head support	1050mm
Electrics	
Accumulators	2 x 12 Volt
Lights	LED directional indicators LED front and rear lights
Range	35km
Suspension / tyres	
Distance between wheels for drive axle	560mm
Distance between wheels for rear axle	370mm
Wheelbase	640mm
Dimensions of front wheel	3.00 - 8
Dimensions of rear wheel	2.00 x 50

22.2 Replacement parts



The replacement of original parts by third-party components or by reproduction (copied) original parts is strictly forbidden! Obtain your spare parts exclusively from your dealer or from PARAVAN GmbH.



See Section "1.1 Your manufacturer"



WARNING

Danger of personal injury when operating the electric wheelchair in a state not conforming to its state upon delivery.
Material damage to the electric wheelchair through non-authorized or incorrectly installed components.

- > Do not make any technical changes to your electric wheelchair.
- > Only operate your electric wheelchair in its original state upon delivery.
- > Use only original or authorised replacement parts.

Driving properties	
Floor clearance	70mm
Maximum height of obstacles	60mm
Turning radius	780mm
Maximum slope (uphill)	12° = 21%**
Maximum slope (downhill)	10° = 17%**
Maximum lateral slope	6° = 11%**
Speed	Standard 6 km/h, optional max. 10km/h*
* The maximum range was measured under test conditions. Weight, terrain and weather conditions may influence this figure in everyday operation.	
** When travelling on steeply inclined terrains do not use top speed, and also travel with particular care where the seat height has been adjusted, there is seat tilt or where the seat length has been changed, and on uneven surfaces (e.g. grass, gravel, sand, ice and snow)!	
 See Section "3 Notes on safety"	

23. Systems and technical documentation

23.1 How to deal with closed accumulators

Where accumulators are completely enclosed, the oxygen liberated at the positive electrode by water decomposition is channelled via a glass fibre mat from the positive to the negative electrode and finally converted back into water at the end of a series of chemical reactions. During charging, a proportion of that oxygen leaks into the common gas area. With closed accumulators, the housing of the accumulator is designed to hold in the pressure by stronger walls in order to prevent the short-term excess oxygen from escaping before being fully recombined at the negative electrode. Where charging is done improperly, hydrogen will be emitted as well as oxygen at the negative electrode. This hydrogen will not be converted into water but may escape through the safety valve if a threshold excess pressure is reached, possibly reaching the oxygen contained in the gas space.

If you avoid improper charging, no water is lost by enclosed accumulators and the accumulators are entirely maintenance-free. During storage and energy consumption there is no oxygen in the gas space and the accumulator will be under a negative pressure. Any valve release should be avoided in all circumstances, since oxidation will occur on the negative electrode if atmospheric oxygen enters the system. This leads to irreparable damage, up to and including total failure of the accumulator.

23.2 Customer service book

- › 1. Inspection (12 months after commissioning)
Date: _____ Signature: _____ Stamp: _____
- › 2. Inspection (annual)
Date: _____ Signature: _____ Stamp: _____
- › 3. Inspection (annual)
Date: _____ Signature: _____ Stamp: _____
- › 4. Inspection (annual)
Date: _____ Signature: _____ Stamp: _____
- › 5. Inspection (annual)
Date: _____ Signature: _____ Stamp: _____
- › 6. Inspection (annual)
Date: _____ Signature: _____ Stamp: _____
- › 7. Inspection (annual)
Date: _____ Signature: _____ Stamp: _____

23.3 EU Declaration of Conformity



Fig. 120: EU Declaration of Conformity

23.4 Protocol of the handover briefing

Due to the flexible options available for setting up your electric wheelchair, you must observe the following points:

Where there is tilt:

- > It should be ensured that the seat is not leaning out too far to the front or back, as this may mean you might slip out of the seat.
- > The tilting is set suitably for your body weight.
- > First set tilt, and then set the back support.
- > Where using tilting always wear your safety belt.
- > Where using tilting travel only at half the speed of the selected driving level.

Seat and back support in the special orthopaedic seat:

- > Adjust the back support only as far as absolutely necessary as the motor does not have the power to lift the weight of the driver. Use the tilt function first.
- > Be careful of other components (the backpack, etc.) when adjusting the back support and tilting.

Lifting arm:

- > Ensure head and leg clearance when lifting and lowering the seat. Foot rests should not come into contact with the ground.
- > With the seat left extended more than about 100mm the electric wheelchair will move at only half speed.

Foot rests:

- › When adjusting the height and angle of the foot rests, be careful that the height does not make contact with the seat padding.
- › The foot rest setting must be higher than any obstacle. In addition, the foot rest must not become caught up by the obstacle, as this may cause the electric wheelchair to topple over.

Seat adjustment forward and back:

- › When you are moving the seat back or forwards, make sure that the foot supports positioned at a low height.
- › When driving the electric wheelchair, make sure that the seat is not in its foremost position, as this could generate a danger of overbalancing!

Control/Joystick

- › Your electric wheelchair is controlled by moving the joystick forwards, backwards and from side to side on the control panel

The Paravan wheelchair series

User manual
PR Piccolino



PARAVAN GmbH

Paravanstraße 5-10
72539 Pfronstetten-Aichelau
Germany

Phone: +49 (0) 73 88 / 99 95-60
Fax: +49 (0) 73 88 / 99 95-999
Email: info@paravan.com