

Invacare® AVIVA™ FX Series

AVIVA FX40

en **Power Wheelchair
User Manual**



This manual **MUST** be given to the user of the product.
BEFORE using this product, this manual **MUST** be read and saved for
future reference.



Yes, you can.®

©2023 Invacare Corporation

All rights reserved. Reproduction, duplication or modification in whole or in part is prohibited without prior written permission from Invacare. Trademarks are identified by ™ and ®. All trademarks are owned by or licensed to Invacare Corporation or its subsidiaries unless otherwise noted.

BraunAbility is a registered trademark of BraunAbility.

Contents

1 General	5
1.1 Introduction	5
1.2 Symbols in this Manual	5
1.3 Compliance	6
1.3.1 Product-Specific Standards	6
1.4 Usability	6
1.5 Warranty Information	7
1.6 Service Life	7
1.7 Limitation of Liability	7
2 Safety	8
2.1 General Safety Notes	8
2.2 Safety Information on the Electrical System	10
2.3 Safety Information on Electromagnetic Interference	12
2.4 Safety Information on Driving and Freewheel Mode	13
2.5 Safety Information With Regard to Care and Maintenance	15
2.6 Safety Information Regarding Changes and Modifications to the Mobility Device	16
2.7 Safety Information on Wheelchairs with a Lifter	18
3 Product Overview	20
3.1 Intended Use	20
3.1.1 Product Description	20
3.1.2 Intended User	20
3.1.3 Indications	20
3.2 Type Classification	20
3.3 Labels on Product	20
3.4 Main Parts of Wheelchair	23
3.5 User Inputs	24
3.6 Powered Seating System	24
4 Options	26
4.1 Posture Belts	26
4.1.1 Types of posture belts	26

4.1.2 Adjusting Posture Belt Correctly	27
4.2 Using Cane Holder	27
5 Usage	29
5.1 Driving	29
5.2 Before Driving for First Time	29
5.3 Parking and Stationary	29
5.3.1 Cleaning Battery Terminals	29
5.4 Getting in and out of Mobility Device	30
5.4.1 Removing Standard Armrest for Side Transfer	30
5.4.2 Information About Getting in and out	30
5.4.3 Swivelling Nucleus Midline Holder to Side	31
5.4.4 Swivelling Swing-Away Display Holder to Side	31
5.4.5 Swivelling Chin Control to Side	32
5.5 Taking Obstacles	32
5.5.1 Maximum Obstacle Height	32
5.5.2 Safety Information When Taking Obstacles	32
5.5.3 Correct Way to Take Obstacles	32
5.6 Driving up and down Gradients	33
5.6.1 Negotiating Inclines	34
5.7 Reaching, Leaning and Bending	34
5.8 Use on Public Roads	35
5.9 Pushing the mobility device in freewheel mode	35
5.9.1 Disengaging Motors	35
6 Control System	37
6.1 Control Protection System	37
6.1.1 Using Circuit Breaker	37
6.2 Batteries	38
6.2.1 General Information on Charging	38
6.2.2 General Instructions on Charging	38
6.2.3 Charging Batteries	39
6.2.4 Disconnecting Mobility Device After Charging	39
6.2.5 Storage and Maintenance	40
6.2.6 Instructions on Using Batteries	40
6.2.7 Transporting Batteries	41
6.2.8 General Instructions on Handling Batteries	41

6.2.9	Handling Damaged Batteries Correctly	41
7	Transport	43
7.1	Transport — General Information.	43
7.2	Transferring Mobility Device to Vehicle	44
7.3	Use Mobility Device as Vehicle Seat.	44
7.3.1	Anchoring Mobility Device Used as Vehicle Seat	46
7.3.2	Securing User in Mobility Device	47
7.4	Transporting Mobility Device Without Occupant.	50
7.5	Dahl Docking System.	50
8	Maintenance	56
8.1	Maintenance Introduction	56
8.2	Inspection Checks	56
8.2.1	Before Each Use of Mobility Device	56
8.2.2	Weekly	57
8.2.3	Monthly.	57
8.3	Wheels and Tyres	58
8.4	Short-Term Storage	59
8.5	Long-Term Storage	59
8.6	Cleaning and Disinfection	59
8.6.1	General Safety Information.	59
8.6.2	Cleaning Intervals.	60
8.6.3	Cleaning	60
8.6.4	Disinfection Instructions	61
9	After Use	62
9.1	Reconditioning	62
9.2	Disposal	62
10	Technical Data	63
10.1	Technical Specifications	63
11	Service.	69
11.1	Inspections Performed.	69

1 General

1.1 Introduction

This user manual contains important information about the handling of the product. To ensure safety when using the product, read the user manual carefully and follow the safety instructions.

Only use this product if you have read and understood this manual. Seek additional advice from a healthcare professional who is familiar with your medical condition and clarify any questions regarding the correct use and necessary adjustment with the healthcare professional.

Note that there may be sections in this document, which are not relevant to your product, since this document applies to all available models (on the date of printing). If not otherwise stated, each section in this document refers to all models of the product.

The models and configurations available in your country can be found in the country-specific sales documents.

Invacare reserves the right to alter product specifications without further notice.

Before reading this document, make sure you have the latest version. You find the latest version as a PDF on the Invacare website.

If you find that the font size in the printed document is difficult to read, you can download the PDF version from the website. The PDF can then be scaled on screen to a font size that is more comfortable for you.

For more information about the product, for example product safety notices and product recalls, contact your Invacare distributor. See addresses at the end of this document.

In case of a serious incident with the product, you should inform the manufacturer and the competent authority in your country.

1.2 Symbols in this Manual

Symbols and signal words are used in this manual and apply to hazards or unsafe practices which could result in personal injury or property damage. See the information below for definitions of the signal words.



DANGER

Indicates a hazardous situation that will result in serious injury or death if it is not avoided.



WARNING

Indicates a hazardous situation that could result in serious injury or death if it is not avoided.



CAUTION

Indicates a hazardous situation that could result in minor or slight injury if it is not avoided.



NOTICE

Indicates a hazardous situation that could result in damage to property if it is not avoided.



Gives useful tips, recommendations and information for efficient, trouble-free use.



Identifies required tools, components and items which are needed to carry out certain work.

Other Symbols

(Not applicable for all manuals)



UK Responsible Person
Indicates if a product is not manufactured in the UK.



Triman
Indicates recycling and sorting rules (only relevant for France).

1.3 Compliance

Quality is fundamental to the company's operation, working within the disciplines of ISO 13485.

This product features the CE mark, in compliance with the Medical Device Regulation 2017/745 Class I.

This product features the UKCA mark, in compliance with Part II UK MDR 2002 (as amended) Class I.

We are continuously working towards ensuring that the company's impact on the environment, locally and globally, is reduced to a minimum.

We only use REACH compliant materials and components.

We comply with the current environmental legislations WEEE and RoHS.

1.3.1 Product-Specific Standards

The product has been tested and conforms to EN 12184 (Electrically powered wheelchairs, scooters and their chargers) and all related standards.

When equipped with an appropriate lighting system, the product is suitable for use on public roads.

For further information about local standards and regulations, contact your local Invacare distributor. See addresses at the end of this document.

1.4 Usability

Only use a mobility device when it is in perfect working order. Otherwise, you might put yourself and others at risk.

The following list does not claim to be exhaustive. It is only intended to show some of the situations that could affect the usability of your mobility device.

In certain situations, you should immediately stop using your mobility device. Other situations allow you to use the mobility device to get to your provider.

You should immediately stop using your mobility device if its usability is restricted due to:

- Unexpected driving behaviour
- brake failure

You should immediately contact an authorised Invacare provider if the usability of your mobility device is restricted due to:

- the lighting system (if fitted) failing or being defective

- reflectors falling off
- worn thread or insufficient tire pressure
- damage to the armrests (e.g. torn armrest padding)
- damage to the legrest hangers (e.g. missing or torn heel straps)
- damage to the postural belt
- damage to the joystick (joystick cannot be moved into the neutral position)
- cables that are damaged, kinked, pinched or have come loose from the fixation
- the mobility device drifting when braking
- the mobility device pulling to one side when moving
- unusual sounds developing or occurring

Or if you have the feeling that something is wrong with your mobility device.

1.5 Warranty Information

We provide a manufacturer's warranty for the product in accordance with our General Terms and Conditions of Business in the respective countries.

Warranty claims can only be made through the provider from whom the product was obtained.

1.6 Service Life

We estimate a service life of five years for this product, provided it is used in strict accordance with the intended use as set out in this document and all maintenance and service requirements are met. The estimated service life can be exceeded if the product is carefully used and properly maintained, and provided technical and scientific advances do not result in technical limitations. The service life can

also be considerably reduced by extreme or incorrect usage. The fact that we estimate a service life for this product does not constitute an additional warranty.

1.7 Limitation of Liability

Invacare accepts no liability for damage arising from:

- Non-compliance with the user manual
- Incorrect use
- Natural wear and tear
- Incorrect assembly or set-up by the purchaser or a third party
- Technical modifications
- Unauthorised modifications and/or use of unsuitable spare parts

2 Safety

2.1 General Safety Notes



WARNING!

Risk of Serious Injury or Damage

Improper use of this product may cause injury or damage.

- If you are unable to understand the warnings, cautions or instructions, contact a health care professional or provider before attempting to use this equipment.
- Do not use this product or any available optional equipment without first completely reading and understanding these instructions and any additional instructional material such as user manual, service manual or instruction sheet supplied with this product or optional equipment.



DANGER!

Risk of Death, Serious Injury, or Damage

Lighted cigarettes dropped onto an upholstered seating system can cause a fire resulting in death, serious injury, or damage. Mobility device occupants are at particular risk of death or serious injury from these fires and resulting fumes because they may not have the ability to move away from the mobility device.

- DO NOT smoke while using this mobility device.



WARNING!

Risk of Injury, Damage or Death

Improper monitoring or maintenance may cause injury, damage or death due to ingestion or choking on parts or materials.

- Closely supervise children, pets, or people with physical/mental disabilities.



WARNING!

Risk of Death, Serious Injury or Damage

Improper routing of cables may cause a tripping entanglement or strangulation hazard that may result in death, serious injury or damage.

- Ensure all cables are routed and secured properly.
- Ensure there are no loops of excess cable extending away from the wheelchair.



WARNING!

Risk of damage or injury if mobility device is accidentally set into motion

- Switch the mobility device off before you get in, get out or handle unwieldy objects.
- When the drive is disengaged, the brake inside the drive is deactivated. For this reason, pushing the mobility device by an attendant is only recommended on flat surfaces, never on gradients. Never leave your mobility device on a gradient with its motors disengaged. Always re-engage the motors immediately after pushing the mobility device (refer to Pushing the mobility device in freewheel mode).

**WARNING!**

Risk of injury if the mobility device is driven when ability to operate a vehicle is impaired by medication or alcohol

- Never drive the mobility device under the influence of medication or alcohol. If necessary, the mobility device must be operated by an attendant who is physically and mentally able.

**WARNING!**

Risk of injury when transferring mobility device to a vehicle for transport with the occupant seated in it

- It is always better to transfer the mobility device to a vehicle without the occupant seated in it.
- If the mobility device needs to be loaded up a ramp together with its driver, ensure that the ramp does not exceed the rated slope (refer to *10 Technical Data, page 63*).
- If the mobility device does need to be loaded using a ramp which exceeds the rated slope (refer to *10 Technical Data, page 63*), then you must use a winch. An attendant can safely monitor and assist the loading process.
- As an alternative you can use a platform lift. Ensure that the total weight of the mobility device including the user does not exceed the maximum permissible weight for the platform lift or winch if you are using.

**WARNING!**

Risk of injury if the mobility device is switched off while driving, for example by pressing the On/Off Button or disconnecting a cable, due to it coming to an abrupt, sharp stop

- If you have to brake in an emergency, simply release the joystick which will bring you to a halt (refer to the remote user manual for more information).

**WARNING!**

Risk of falling out of the mobility device

- Do not slide forward on the seat, do not lean forward between your knees, do not lean backwards out over the top of the backrest, for example to reach an object.
- If a posture belt is installed, it should be correctly adjusted and used each time you use the mobility device.
- When transferring to a different seat, position the mobility device as close as possible to the new seat.

**WARNING!**

Risk of Serious Injury or Damage

Storing or using the mobility device near open flame or combustible products can result in serious injury or damage.

- Avoid storing or using the mobility device near open flame or combustible products.



CAUTION!

Risk of injury if maximum permissible load is exceeded

- Do not exceed the maximum permissible load (refer to *10 Technical Data, page 63*).
- The mobility device is only designed for use by a single occupant whose maximum weight does not exceed the maximum permissible load of the device. Never use the mobility device to transport more than one person.



CAUTION!

Risk of injury due to wrong lifting or dropping of heavy components

- When maintaining, servicing or lifting any part of your mobility device, take into account the weight of the individual components especially the batteries. Be sure at all times to adopt the correct lifting posture and ask for assistance if necessary.



CAUTION!

Risk of injury by moving parts

- Make sure that no injury is incurred by moving parts of the mobility device, like wheels or one of the lifter modules (if fitted), especially when children are around.



CAUTION!

Risk of injury from hot surfaces

- Do not leave the mobility device in direct sunlight for prolonged periods. Metal parts and surfaces such as the seat and armrests can become very hot.



CAUTION!

Risk of fire or breaking down due to electric devices being connected

- Do not connect any electric devices to your mobility device that are not expressly certified by Invacare for this purpose. Have all electrical installations done by your authorized Invacare provider.

2.2 Safety Information on the Electrical System



WARNING!

Risk of death, serious injury or damage

- Misuse of the mobility device may cause the mobility device to start smoking, sparking, or burning. Death, serious injury, or damage may occur due to fire.
- DO NOT use the mobility device other than its intended purpose.
 - If the mobility device starts smoking, sparking, or burning, discontinue using the mobility device and seek service IMMEDIATELY.

**WARNING!****Risk of death or serious injury**

Electric shock can cause death or serious injury
 – To avoid electric shock, inspect plug and cord for cuts and/or frayed wires. Replace cut cords or frayed wires immediately.

**WARNING!****Risk of death or serious injury**

Failure to observe these warnings can cause an electrical short resulting in death, serious injury, or damage to the electrical system.

- The POSITIVE (+) RED battery cable MUST connect to the POSITIVE (+) battery terminal(s)/post(s). The NEGATIVE (-) BLACK battery cable MUST connect to the NEGATIVE (-) battery terminal(s)/post(s).
- NEVER allow any of your tools and/or battery cable(s) to contact BOTH battery post(s) at the same time. An electrical short may occur and serious injury or damage may occur.
- Install protective caps on positive and negative battery terminals.
- Replace cable(s) immediately if cable(s) insulation becomes damaged.
- DO NOT remove fuse or mounting hardware from POSITIVE (+) red battery cable mounting screw.

**WARNING!****Risk of death, serious injury, or damage**

Corroded electrical components due to water or liquid exposure can result in death, serious injury, or damage.

- Minimize exposure of electrical components to water and/or liquids.
- Electrical components damaged by corrosion MUST be replaced immediately.
- Mobility devices that are frequently exposed to water/liquids may require replacement of electrical components more frequently.

**WARNING!****Risk of fire**

Switched on lamps produce heat. If you cover the lamps with fabrics such as clothes, there is a risk that the fabric may catch fire.

- NEVER cover the light system with fabric.

**WARNING!****Risk of death, serious injury or damage when carrying along oxygen systems**

Textiles and other materials that normally would not burn are easily ignited and burn with great intensity in oxygen enriched air.

- Check the oxygen tubing daily, from the cylinder to the delivery site, for leaks and hold away from electrical sparks and any source of ignition.

**WARNING!****Risk of injury or damage due to electrical shorts**

Connector pins on cables connected to the power module can still be live even when the system is off.

- Cables with live pins should be connected, restrained or covered (with non-conductive materials) so that they are not exposed to human contact or materials that could cause electrical shorts.
- When cables with live pins have to be disconnected, for example, when removing the bus cable from the remote for safety reasons, make sure to restrain or cover the pins (with non-conductive materials).

**NOTICE!**

A failure in the electric system can lead to unusual behavior such as continuous light, no light, or noises from the magnetic brakes.

- If a failure exists, switch off the remote and switch it on again.
- If a failure still exists, then disconnect or remove the power source. Depending on the mobility device model, you can either remove the battery packs or disconnect the batteries from the power module. If in doubt which cable to disconnect, contact your provider.
- In any case, contact your provider.

2.3 Safety Information on Electromagnetic Interference

This powered mobility device was successfully tested in accordance with International standards as to its compliance with Electromagnetic Interference (EMI) regulations. However, electromagnetic fields, such as those generated by radio and television transmitters, and cellular phones can influence the functions of powered mobility devices. Also, the electronics used in our mobility devices can generate a low level of electromagnetic interference, which however will remain within the tolerance permitted by law. For these reasons we ask you to please observe the following precautions:

**WARNING!****Risk of malfunction due to electromagnetic interference**

- Do not switch on or operate portable transceivers or communication devices (such as radio transceivers or cellular phones) when the mobility device is switched on.
- Avoid getting near strong radio and television transmitters.
- In case the mobility device should be set in motion unintentionally or the brakes are released, switch it off immediately.
- Adding electrical accessories / options and other components or modifying the mobility device in any way can make it susceptible to electromagnetic interference. Keep in mind that there is no sure way to determine the effect such modifications will have on the overall immunity of the electronic system.
- Report all occurrences of unintentional movement of the mobility device, or release of the electric brakes to the manufacturer.

2.4 Safety Information on Driving and Freewheel Mode

**DANGER!****Risk of death, serious injury, or damage**

- Malfunctioning joystick could cause unintended/erratic movement resulting in death, serious injury, or damage
- If unintended/erratic movement occurs, stop using the wheelchair immediately and contact a qualified technician.

**WARNING!****Risk of serious injury or damage**

- Improper positioning while leaning or bending could cause the wheelchair to tip forward resulting in serious injury or damage
- To assure stability and proper operation of your mobility device, you must at all times maintain proper balance. Your power wheelchair has been designed to remain upright and stable during normal daily activities as long as you DO NOT move beyond the centre of gravity.
 - DO NOT lean forward out of the mobility device any further than the length of the armrests.
 - DO NOT attempt to reach objects if you have to move forward in the seat or pick them up from the floor by reaching down between your knees.



WARNING!

Risk of breaking down in adverse weather conditions, i.e. extreme cold, in an isolated area

- If you are a user with severely limited mobility, we advise that in the case of adverse weather conditions DO NOT attempt a journey without an accompanying attendant.



WARNING!

Risk of injury if the mobility device tips over

- Inclines and declines can only be travelled up to the maximum safe slope (refer to *10 Technical Data, page 63*).
- Always return the backrest of your seat or the seat tilt to an upright position before ascending slopes. We recommend that you position the seat backrest and the seat tilt (if fitted) slightly to the rear before descending slopes.
- Only ever drive downhill at a maximum of 2/3 of the top speed. Avoid abrupt braking or accelerating on gradients.
- If at all possible, avoid driving on wet, slippery, icy, or oily surfaces (such as snow, gravel, ice etc.) where there is a risk of you losing control over the vehicle, especially on a gradient. This may include certain painted or otherwise treated wood surfaces. If driving on such a surface is inevitable, then always drive slowly and with the utmost caution.
- Never attempt to overcome an obstacle when on an uphill or downhill gradient.



WARNING!

Risk of injury if the mobility device tips over (continued)

- Never attempt to drive up or down a flight of steps with your mobility device.
- When overcoming obstacles, always observe the maximum obstacle height (refer to *10 Technical Data, page 63* and information about overcoming obstacles in *5.5 Taking Obstacles, page 32*).
- Avoid shifting your centre of gravity as well as abrupt joystick movements and changes of direction when the mobility device is in motion.
- Never use the mobility device to transport more than one person.
- Do not exceed the overall maximum permissible load or the maximum load per axle (refer to *10 Technical Data, page 63*).
- Note that the mobility device will brake or accelerate if you change the driving mode whilst the mobility device is in motion.



WARNING!

Risk of injury if your foot slides off the footrest and gets caught underneath the mobility device when it is in motion

- Make sure each time before you drive the mobility device that your feet are squarely and securely in place on the footplates, and that both legrests are properly locked into place.

**WARNING!**

Risk of injury if you collide with an obstacle when driving through narrow passages such as doorways and entrances

- Drive through narrow passages in the lowest driving mode and with due caution.

**WARNING!**

Risk of injury

If your mobility device has been fitted with elevating legrests, there is a risk of personal injury and damage to the mobility device if you drive the mobility device with the legrests raised.

- To avoid unwanted displacement of the mobility device centre of gravity to the front (especially when travelling downhill) and in order to avoid damage to the mobility device, elevating legrests must always be lowered during normal travelling.

**WARNING!**

Tipping hazard if antitippers are removed, damaged or changed to a position different to the factory settings

- Antitippers should only ever be removed for dismantling the mobility device for transport in a vehicle or for storage.
- The antitippers must always be fitted if the mobility device is being used.

**WARNING!**

Risk of tipping

Antitippers (stabilizers) are only effective on firm ground. They sink in on soft ground such as grass, snow or mud if the mobility device rests itself on them. They lose their effect and the mobility device can tip over.

- Only drive with extreme care on soft ground, especially during uphill and downhill journeys. In the process pay increased attention to the tip stability of the mobility device.

2.5 Safety Information With Regard to Care and Maintenance

**WARNING!**

Risk of death, serious injury, or damage

Incorrect repair and/or servicing of this mobility device performed by users/caregivers or unqualified technicians can result in death, serious injury, or damage.

- DO NOT attempt to carry out maintenance work that is not described in this user manual. Such repair and/or service **MUST** be performed by a qualified technician. Contact a provider or Invacare technician.

**CAUTION!****Risk of accident and loss of warranty if maintenance is insufficient**

- For reasons of safety and in order to avoid accidents which result from unnoticed wear, it is important that this mobility device undergoes an inspection once every year under normal operating conditions (see inspection plan contained in service instructions).
- Under difficult operating conditions such as daily travel on steep slopes, or in the case of use in medical care cases with frequently changing mobility device users, it would be expedient to carry out intermediate checks on the brakes, accessories / options and running gear.
- If the mobility device is to be operated on public roads, the vehicle driver is responsible for ensuring that it is in an operationally reliable condition. Inadequate or neglected care and maintenance of the mobility device will result in a limitation of the manufacturer's liability.

2.6 Safety Information Regarding Changes and Modifications to the Mobility Device**WARNING!****Risk of serious injury or damage**

- Use of incorrect or improper replacement (service) parts may cause injury or damage
- Replacement parts **MUST** match original Invacare parts.
 - Always provide the wheelchair serial number to assist in ordering the correct replacement parts.

**CAUTION!****Risk of injuries and damage to mobility device due to unapproved components and accessories / options**

- Seating systems, additions and accessories / options which have not been approved by Invacare for use with this mobility device can affect the tipping stability and increase tipping hazards.
- Only ever use seating systems, additions and accessories / options which have been approved by Invacare for this mobility device.

Seating systems which are not approved by Invacare for use with this mobility device do not, under certain circumstances, comply with the valid standards and could increase the flammability and the risk of skin irritation.

- Only use seating systems that have been approved by Invacare for this mobility device.

**CAUTION!****Risk of injuries and damage to mobility device due to unapproved components and accessories / options**

Electrical and electronic components which have not been approved by Invacare for use with this mobility device can cause fire hazards and lead to electromagnetic damage.

- Only ever use electrical and electronic components which have been approved by Invacare for this mobility device.

Batteries which have not been approved by Invacare for use with this mobility device can cause chemical burns.

- Only ever use batteries which have been approved by Invacare for this mobility device.

**CAUTION!****Risk of injuries, and damage to the mobility device, if unapproved backrests are used**

A retrofitted backrest which is not approved by Invacare for use with this mobility device may overload the backrest tube and thus increase the risk of injuries and of damage to the mobility device.

- Please contact your Invacare specialist provider who will perform risk analyses, calculations, stability checks etc. to ensure that the backrest can be used safely.

**CE marking of the mobility device**

- The conformity assessment/CE marking was carried out according to the respective valid regulations and only applies to the complete product.
- The CE marking is invalidated if components or accessories / options are replaced or added that have not been approved for this product by Invacare.
- In this case, the company that adds or replaces the components or accessories / options is responsible for the conformity assessment/CE marking or for registering the mobility device as a special design and for the relevant documentation.

**Important information about maintenance work tools**

- Some maintenance work which is described in this manual and can be carried out by the user without problems require the correct tools for proper work. If you do not have the correct tool available we do not recommend that you try to carry out the relevant work. In this case, we urgently recommend that you contact an authorized specialist workshop.

2.7 Safety Information on Wheelchairs with a Lifter



WARNING!

Risk of injury by moving parts

- Never let objects get caught in the space underneath a raised lifter.
- Make sure that neither you nor anyone else is injured by placing hands, feet or other body extremities under the raised seat.
- Should you not be able to view under the seat, for example, due to limited manoeuvrability, turn the wheelchair once on its own axle before you lower the seat. This will allow you to make sure that nobody is located in the danger zone.



CAUTION!

Risk of malfunction of the lifter module

- Inspect the lifter module at regular intervals to make sure there are no foreign objects or visible damage, and to make sure the electric plugs are firmly inserted into their sockets.



CAUTION!

Damage to wheelchair caused by one-sided loading on lifter pillar

- One-sided loading occurs if the seat is raised and/or tilted. Always return your seat backrest to the upright position and the seat tilting to the horizontal position before ascending slopes. Never subject the lifter pillar to continuous single-sided loading. The raising and tilting function of the seat only provides additional rest positions.



CAUTION!

Risk of injury if the wheelchair tips over

- Never exceed the maximum permissible load (see chapter 10 *Technical Data*, page 63).
- Avoid dangerous driving situations when the lifter is in a raised position, such as trying to overcome obstacles like curbs or driving up or down steep gradients.
- Never lean out of the seat when the lifter is raised.
- Inspect the lifter module at least once a month to make sure the automatic speed reduction function, which reduces the speed of the wheelchair when the lifter is raised, is working properly (see chapter *Powered Seating System*). Notify your authorized provider immediately if it is not working properly.



Important information regarding speed reduction with raised lifter

- If the lifter has been raised above a certain point, the drive electronics considerably reduces the speed of the wheelchair. If speed reduction has been activated, drive mode can only be used to carry out minor movements of the wheelchair and not for regular driving. To drive normally, lower the lifter until the speed reduction has been deactivated again. See chapter *Powered Seating System* for details.

3 Product Overview

3.1 Intended Use

3.1.1 Product Description

The AVIVA FX is a front wheel drive power wheelchair that can be established with a multitude of configurations.

The AVIVA FX40 is equipped with a 120 A power module and a 73.5 Ah battery by default. The AVIVA FX40 also has powered seating functions available.

3.1.2 Intended User

This mobility device was designed for adults and adolescents whose ability to walk is impaired, but who are still in terms of their eyesight and physically and mentally able to operate an electric mobility device.

3.1.3 Indications

The use of this power wheelchair is recommended for the following indications:

- The inability or a greatly restricted ability to walk within the scope of the basic requirement to be able to move within one's own four walls.
- The need to leave the dwelling place in order to get some fresh air during a short walk or to reach those places generally to be found at close distance to the dwelling and where everyday business is carried out.

Provision of power wheelchairs for interior and exterior areas is advisable if the use of hand-operated wheelchairs is no longer possible on account of the disability, yet proper operation of an electromotive drive unit is still practicable.

Contraindications

There are no contraindications known.

3.2 Type Classification

This vehicle has been classified according to EN 12184 as a **class B mobility product** (for indoor and outdoor areas). It is therefore compact and agile enough for indoor areas, but also able to overcome many obstacles in outdoor areas.

3.3 Labels on Product

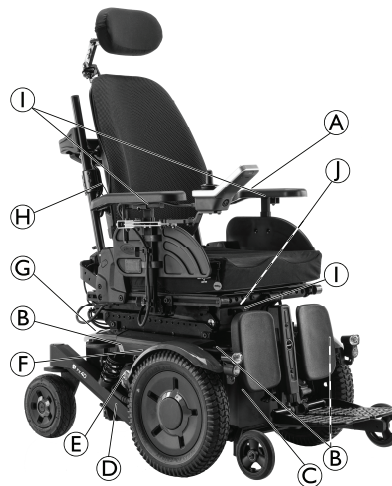

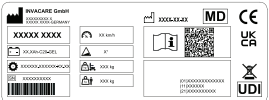

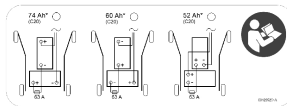

























Fig. 3-1





<p>Ⓐ</p>		<p>If the mobility device is fitted with a tray, it is imperative that it is removed and safely stored when transporting the mobility device in a vehicle.</p>
<p>Ⓑ</p>	<p>Identification of the tie-down points at the front and back:</p>	<p>If the symbol appears on a bright yellow sticker, the anchoring point is suitable for fixation of the mobility device in a vehicle for use as a vehicle seat.</p>
<p>Ⓒ</p>	 <p>ISO 7176-19</p>	<p>Warning that the mobility device may not be used as a vehicle seat</p> <p>This mobility device does not satisfy the requirements of ISO 7176-19.</p>
<p>Ⓓ</p>		<p>Identification label sticker on the chassis at the right.</p> <p>For details see below.</p>



<p>Ⓔ</p>		<p>Identification of the position of the coupling lever for driving and push operation (only the right side visible in the picture).</p> <p>For details see below.</p>
<p>Ⓕ</p>		<p>Warning regarding the use of the lifter.</p> <p>For details see below.</p>
<p>Ⓖ</p>		<p>Battery wiring diagram label</p>
<p>Ⓗ</p>		<p>Indication not to strain back with more than 6 kg.</p>
<p>Ⓘ</p>		<p>Indication of pinch points that could occur on the mobility device.</p>
<p>⓵</p>		<p>Identification of the ON/OFF position of the circuit breaker switch (on the left side of mobility device).</p> <p>For details see below.</p>

Explanation of Symbols on Labels

	Manufacturer
	Date of manufacture
	European Conformity
	UK Conformity Assessed
	Medical device
	Serial number
	WEEE Conformity
	Unique Device Identification
	Battery type
	Factory setting
	Maximum speed
	Rated slope

	Unladen weight
	Maximum user weight
	Read the user manual
	QR code contains link to user manual
	Do not lean out when the lifter is raised!
	Do not drive up or down slopes when the lifter is raised!
	Do not allow any body parts to get under a raised seat!
	Never drive with two people!
	Never drive over uneven surfaces when the lifter is raised!

	<p>This symbol indicates the “Drive” position of the coupling lever. In this position the motor is engaged and the motor brakes are operational. You can drive the mobility device.</p> <ul style="list-style-type: none"> Note that for driving purposes both motors must always be engaged.
	<p>This symbol indicates the “Push” position of the coupling lever. In this position the motor is disengaged and the motor brakes are not operational. The mobility device can be pushed by an attendant and the wheels turn freely.</p> <ul style="list-style-type: none"> Note that the remote must be switched off. Also note the information provided in section 5.9 <i>Pushing the mobility device in freewheel mode, page 35.</i>
	<p>This symbol indicates the OFF position of the circuit breaker switch. In this position the battery source is isolated and the mobility device cannot be operated or charged.</p>
	<p>This symbol indicates the ON position of the circuit breaker switch. In this position the battery source is connected and the mobility device can be operated or charged.</p>

	<p>This symbol indicates the circuit breaker.</p>
	<p>Read the user manual. This symbol appears on different labels and positions.</p>

3.4 Main Parts of Wheelchair



Fig. 3-2

- Ⓐ Back Cushion
- Ⓑ Remote
- Ⓒ Armrest
- Ⓓ Seat cushion
- Ⓔ Legrest

- Ⓕ Anti tipper
- Ⓖ Drive wheel
- Ⓗ Castor
- Ⓘ Fork
- Ⓛ Push handle (not shown)
- Ⓚ Headrest

3.5 User Inputs

Your mobility device may be fitted with one of several different user inputs. For information on the different functions and how to operate a particular user input, refer to its corresponding user manual (enclosed).

3.6 Powered Seating System

The powered seating system is operated from the remote. Refer to the remote manual for more information.

The powered seating system may include the following functions, depending on the modules installed:

- Tilt
- Recline
- Tilt with elevating seat
- Tilt and recline with elevating seat
- Powered elevating center mounted legrest
- Powered elevating dual legrests



Information regarding operation of the lifter at temperatures of less than 0 °C

- Invacare mobility devices are fitted with safety mechanisms that prevent capacity overload of the electronic components. At operating temperatures below freezing point this can, in particular, lead to the lifter actuator being shut down after approx. 1 second operating time.
- The lifter can be raised or lowered gradually by repeatedly operating the joystick. In many cases this generates sufficient heat for the actuator to operate as normal.



Speed limiter

The speed limit reacts in different ways, depending on the mobility device's configuration.

- Either the lifter is fitted with sensors which reduce the mobility device's speed as soon as the lifter is raised above a certain point.
- Or if the speed limit is activated, a reduced drive level (forced profile) is set automatically. Refer to the remote manual for more information.
- The speed reduction takes place to guarantee the tipping stability of the mobility device and to avoid personal risk and damage to the mobility device.
- To reapply normal speed, lower the lifter down until the forced profile or the speed reduction switches off.
- If the mobility device is fitted with a chin control, it reacts different to forced profile. Refer to the manual of the chin control for more information.



CAUTION!

Risk of tipping, if the speed limiter sensors fail when the lifter is raised

- If you find that the speed reduction function is not working when the lifter is raised, do not drive with the lifter raised and immediately contact an authorized Invacare provider.

4 Options

4.1 Posture Belts

A posture belt is an option which can either be fixed to the mobility device ex-works or can be retrofitted by your specialist provider. If your mobility device is fitted with a posture belt, your specialist provider will have informed you about fitting and usage.

The posture belt is used to help the mobility device user keep an optimum seating position. Correct use of the belt assists the user in sitting securely, comfortably and well-positioned in the mobility device, especially for such users who do not have such a good sense of balance while sitting.



We recommend using the posture belt whenever the mobility device is used.

4.1.1 Types of posture belts

Your mobility device can be fitted with the following posture belt types ex-works. If your mobility device has been fitted with a different belt to those listed below, please ensure that you have received the manufacturer's documentation with regard to correct fitting and use.

Belt with metal buckle, adjustable both sides



Belt can be adjusted on both sides. This means that the buckle can be centrally positioned.

Belt with plastic buckle, adjustable both sides



Belt can be adjusted on both sides. This means that the buckle can be centrally positioned.

Harness with metal buckle, adjustable on both sides

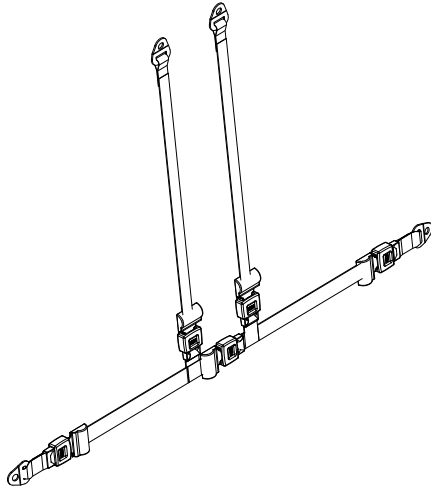

Harness can be adjusted on both sides. This ensures that the buckle is always centrally positioned.

4.1.2 Adjusting Posture Belt Correctly



The belt should be tight enough to ensure that you are sitting comfortably and that your body is in the correct sitting position.

1. Ensure that you are sitting correctly, which means that you are sitting right at back of seat, your pelvis is positioned erect and as symmetrically as possible, not to front, to side or at one edge of seat.
2. Position posture belt so that your hipbones can be easily felt above belt.

3. Adjust belt length using one of adjustment aids described above. The belt should be adjusted so that you can fit a flat hand between belt and your body.
4. Buckle should be positioned as centrally as possible. In doing so, carry out adjustments on both sides as much as possible.
5. Check your belt every week to ensure that it is still in good working condition, to ensure it has no damage or wear, and that it is fixed properly to mobility device. If belt is only fastened with a bolted connection, ensure that connection has not loosened or come undone. You can find more information about maintenance work on belts in the service manual, which is available from Invacare.

4.2 Using Cane Holder

If your mobility device is fitted with a cane holder, it can be used for the safe transport of a walking cane, underarm or forearm crutches. The cane holder consists of a plastic container (bottom) and a hook-and-loop fastener (top).



CAUTION! **Risk of Injury**

A walking cane or crutches that are not secured during transport (on the user's lap, for example) can cause injury to the user or other persons.

- During transport, walking canes or crutches should always be secured using a cane holder.

1. Open upper hook-and-loop fastener.
2. Place lower end of the walking cane or crutches in container at bottom.
3. Walking cane or crutches can be secured at upper end using hook-and-loop fastener.

5 Usage

5.1 Driving



The maximum load capacity that is stated in the technical data only states that the system is designed for this mass in total. However, this does not mean that one can sit a person with this body weight in the mobility device without restrictions. Attention must be paid to the body proportions, such as height, weight distribution, abdominal belt, leg and calf strap and seat depth. These factors have a strong influence on driving features such as tilt stability and traction. The permissible axle loads in particular must be adhered to (refer to *10 Technical Data, page 63*). It may possibly be necessary to carry out adaptations to the seat system.

5.2 Before Driving for First Time

Before you take your first trip, you should familiarise yourself well with the operation of the mobility device and with all operating elements. Take your time to test all functions and driving modes.



If installed, make sure to properly adjust and use the posture belt each time you use the mobility device.

Sitting comfortably = Driving safely

Before each trip, make sure that:

- You are within easy reach of all operating controls.
- The battery charge is sufficient for the distance you intend to travel.

- The posture belt (if installed) is in perfect order.
- The rear mirror (if installed) is adjusted so you can look behind at all times without having to bend forward or shift your seating position.

5.3 Parking and Stationary

When parking your mobility device or if your mobility device is stationary for a prolonged period:

1. Switch the mobility device's power system off (ON-/OFF key).

5.3.1 Cleaning Battery Terminals



WARNING!

- Most batteries are not sold with instructions. However, warnings are frequently noted on the cell caps. Read them carefully.
- DO NOT allow the liquid in the battery to come in contact with skin, clothes or other possessions. It is a form of acid and harmful or damaging burns may result. Should the liquid touch your skin, wash the area IMMEDIATELY and thoroughly with cool water. In serious cases or if eye contact is made, seek medical attention IMMEDIATELY.

1. Examine battery terminals for corrosion.
2. Verify the plastic caps are in place over battery cell holes.

- Clean terminals by using a battery cleaning tool, wire brush, or medium grade sand paper.

 Upon completion, areas should be shiny, not dull.

- Carefully dust off all metal particles.

5.4 Getting in and out of Mobility Device

-  – The armrest must be removed or swiveled up in order to get into or out of the mobility device from the side.

5.4.1 Removing Standard Armrest for Side Transfer

 This chapter relates to the standard armrest. For more information about other armrests, see the user manual of the seating system.

Depending on version, the armrest is fixed with one of several fastener options:

- Clamping lever
- Hand screw
- Locking pin
- Locking screw

The graphic below serves as an example.

Depending on which side the remote is installed on, you need to disconnect the remote cable before removing the armrest.

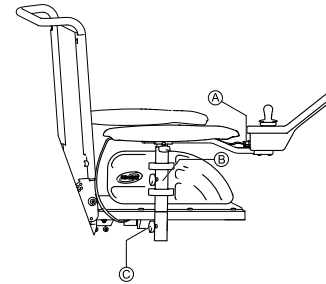

Fig. 5-1

- Pull plug **A** of remote cable to disconnect remote.
- If necessary, remove remote cable from clip **B**.
- Loosen fastener **C**.
- Remove armrest from holder.

5.4.2 Information About Getting in and out

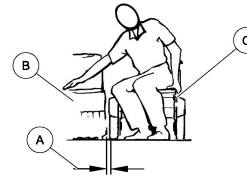

Fig. 5-2

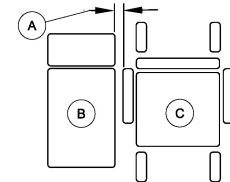

Fig. 5-3

**WARNING!****Risk of serious injury or damage**

Improper transfer techniques may cause serious injury or damage

- Before attempting transfers, consult a healthcare professional to determine proper transfer techniques for the user and type of wheelchair.
- Follow the instructions below.



If you do not have sufficient muscle strength, you should ask other persons for help. Use a sliding board, if possible.

1. Reduce the gap between transfer surface **Ⓑ** and mobility device seat **Ⓒ** to the minimum distance **Ⓐ** necessary to perform transfer. This might have to be done by an attendant.
2. Align castors parallel to drive wheels to improve stability during transfer.
3. Always switch your mobility device off.
4. Always engage both motor locks/clutches and free wheel hubs (if fitted) to prevent wheels from moving.
5. Depending on armrest type of your mobility device, detach armrest or swivel it up.
6. Now slide in or out of your mobility device.

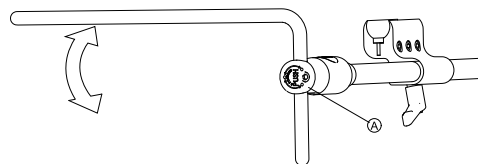
5.4.3 Swivelling Nucleus Midline Holder to Side

1. Push button **Ⓐ** and swivel up or down nucleus.

5.4.4 Swivelling Swing-Away Display Holder to Side

The swing-away display holder only locks in place when swivelled to its default position.

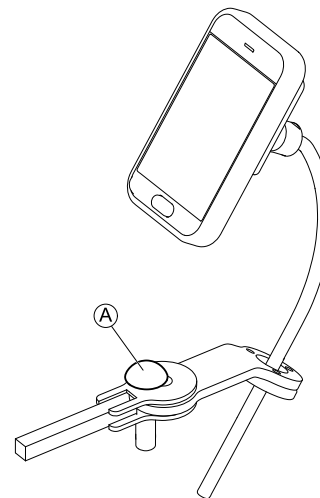

1. Push knob **Ⓐ** and swivel display holder to side.

5.4.5 Swivelling Chin Control to Side

1.

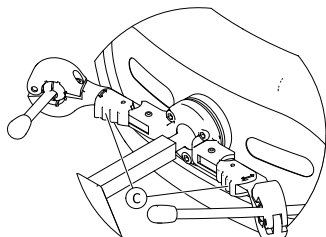

Press locking device © (behind headrest) and swivel joystick or egg switch inwards or outwards until it clicks in place.

5.5 Taking Obstacles

5.5.1 Maximum Obstacle Height

You can find information about maximum obstacle heights in the chapter entitled *10 Technical Data, page 63*.

5.5.2 Safety Information When Taking Obstacles



CAUTION!

Risk of tipping over

- Never approach obstacles at an angle but at 90 degrees as shown below.
- Approach obstacles followed by a gradient with caution. If unsure whether the gradient is too steep or not, move away from the obstacle and if possible try to find another location.
- Never approach obstacles on an uneven and/or loose ground.
- Never drive with too low tire pressure.
- Put your backrest into an upright position before ascending an obstacle.



CAUTION!

Risk of falling out of the mobility device and damage to the mobility device such as broken casters

- Never approach obstacles that are higher than the maximum climbable obstacle height.
- Never let the footrest/legrest touch the ground when descending an obstacle.
- If unsure whether taking an obstacle is possible or not, move away from the obstacle and if possible find another location.

5.5.3 Correct Way to Take Obstacles



The following instructions how to take obstacles also apply for attendants if the mobility device is fitted with an attendant control.

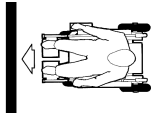

Fig. 5-4 Right



Fig. 5-5 Wrong

Ascending

1. Approach obstacle or curb slowly, head-on and at a right angle.
2. Depending on wheel drive type, stop in one of following positions:
 - a. In the case of centrally driven mobility devices: 5 - 10 cm before obstacle.
 - b. For all other drives: approx. 30 - 50 cm in front of obstacle.
3. Check position of front wheels. They must be in driving direction and at right angles to obstacle.
4. Approach slowly and keep at consistent speed until rear wheels have also passed over obstacle.

5.6 Driving up and down Gradients

For information concerning the maximum safe slope, refer to *10 Technical Data, page 63*.



CAUTION!

Risk of tipping over

- Only ever drive downhill at a maximum of 2/3 of the top speed. Avoid sudden changes of direction or abrupt braking when driving on slopes.
- Always return the backrest of your seat or the seat tilt (if adjustable seat tilt is available) to an upright position before ascending slopes. We recommend that you position the seat backrest or the seat tilt slightly to the rear before descending slopes.
- Always lower the lifter (if fitted) to its lowest position before ascending or descending a slope.
- Never attempt to ascend or descend a slope on slippery surfaces or where there is a risk of skidding (such as wet pavement, ice etc).
- Avoid trying to get out of the mobility device on an incline or a gradient.
- Always drive straight in the direction the road or path you are on goes, rather than attempting to zigzag.
- Never attempt to turn around on an incline or a slope.





CAUTION!

Braking distance is much longer on a downhill slope than on even terrain

- Never drive down a slope that exceeds the rated slope (refer to *10 Technical Data, page 63*).

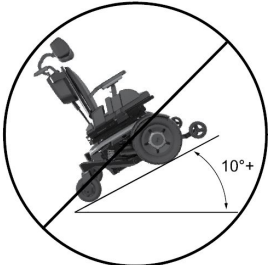
5.6.1 Negotiating Inclines

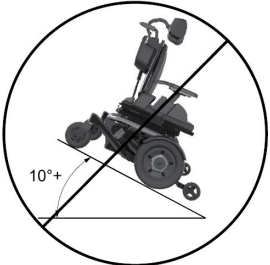
Acceptable Incline Angles 0° to 9°	Avoid Inclines of 10° and above
 <p data-bbox="205 474 284 493">Fig. 5-6</p>	 <p data-bbox="544 490 622 509">Fig. 5-7</p>
 <p data-bbox="205 829 284 848">Fig. 5-8</p>	 <p data-bbox="544 815 622 834">Fig. 5-9</p>

5.7 Reaching, Leaning and Bending

Many activities require the user to reach, lean and bend out of the mobility device. These movements can cause a change to the normal balance, center of gravity and weight distribution of the mobility device. To determine

and establish your particular safety limits, practice reaching, leaning and bending activities in several combinations in the presence of a qualified healthcare professional before attempting active use of the mobility device.

Forwards



Fig. 5-10



Fig. 5-11

1. Align castors parallel to the drive wheels to improve stability.
2. Engage motor locks.
3. Turn off mobility device.
4. Reach, lean or bend only as far as your arm extends without changing your sitting position.

Backwards



Fig. 5-12

1. Position mobility device as close as possible to desired object.
2. Align castors parallel to the drive wheels to improve stability.
3. Engage motor locks.
4. Turn off mobility device.
5. Reach back only as far as your arm extends without changing your sitting position.

5.8 Use on Public Roads

If you wish to use your mobility device on public roads and lighting is required by national legislation, then your mobility device needs to be fitted with an appropriate lighting system. Additional modifications may be required depending on the country.

Contact your Invacare provider if you have any questions.

5.9 Pushing the mobility device in freewheel mode

The motors of the mobility device are equipped with automatic brakes, preventing that the mobility device starts rolling out of control when the remote is switched off. When pushing the mobility device manually whilst freewheeling, the magnetic brakes must be disengaged.

 Pushing the mobility device by hand may require more physical force than expected (more than 100 N). The necessary force nevertheless complies with the requirements of ISO 7176-14.



The intended use of the freewheel mode is to maneuver the mobility device over short distances. The push handles or push bars support this function, but be aware that there might be some impairment between the feet of the assistant and the rear part of the mobility device.

5.9.1 Disengaging Motors



CAUTION!

Risk of the mobility device running away

– When the motors are disengaged (for push operation whilst freewheeling), the electromagnetic motor brakes are deactivated. When the mobility device is parked, the levers for engaging and disengaging the motors must without fail be locked firmly into the "DRIVE" position (electromagnetic motor brakes activated).



The motors may only be disengaged by an attendant, not by the user.

This ensures that the motors are only disengaged if an attendant is available to secure the mobility device and prevent unintended rolling.

The levers for disengaging the motors are located behind the motors.

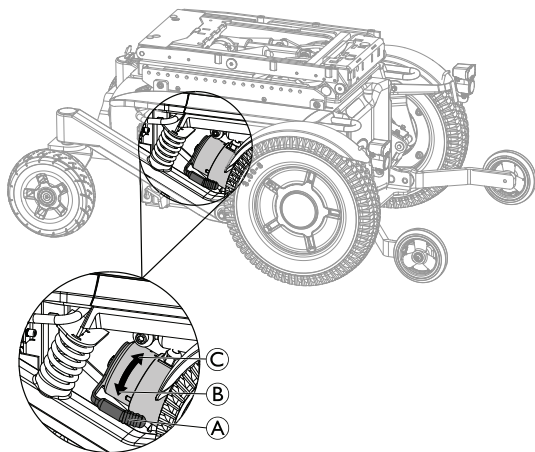

Fig. 5-13

Disengaging Motors

1. Switch off remote.
2. Turn the engaging lever **A** upwards **C**.
The motors are now disengaged.

Re-engaging Motors

1. Turn the engaging lever **A** down **B**.
The motors are now re-engaged.

6 Control System

6.1 Control Protection System

The wheelchair control system is fitted with an overload protection.

If the drive is severely overloaded over a long period of time (for example, when driving up a steep hill) and especially when the ambient temperature is high, the control system could overheat. In this case, the wheelchair performance is gradually reduced until it comes to a halt. The status display shows a corresponding error code (refer to the user manual of your remote). By switching the remote off and back on again, the error code is cleared and the control system is switched back on. It can however take up to five minutes until the control system has cooled down enough for the drive to restore full performance again.

If the drive is stalled by an insurmountable obstacle, for example, a curb or similar which is too high, and the driver attempts driving for more than 20 seconds against this obstacle, the control system automatically switches off to prevent the motors from being damaged. The status display shows a corresponding error code (refer to the user manual of your remote). By switching the remote off and back on again, the error code is cleared and the control system is switched back on.

6.1.1 Using Circuit Breaker

 The circuit breaker must not be used as an ON/OFF button.

When the circuit breaker is used, the LiNX system could lose information such as the correct time displayed on the remote.

 There is no need to use the circuit breaker when transporting the mobility device in a vehicle.

 The mobility device cannot be charged when the circuit breaker is turned off.

 A defective circuit breaker may be replaced only after checking the entire control system. A specialised Invacare provider must perform the replacement. For more information about the circuit breaker type, see *10 Technical Data, page 63*.

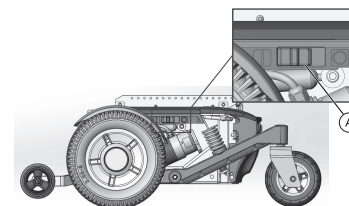

FRONT of wheelchair

BACK of wheelchair

The circuit breaker  is located on the left side of the battery box.

The circuit breaker is an additional safety feature of the control protection system. When the system is overloaded, the circuit breaker turns off automatically. In a hazardous situation or when the mobility device starts to behave erratically, the circuit breaker can be used to isolate the battery source quickly.

It can also be used to turn off the power supply of the mobility device manually, when the mobility device is transported without surveillance, for example, while travelling by air. See *7.4 Transporting Mobility Device Without Occupant, page 50*.

1. To turn off power supply manually, move circuit breaker switch towards BACK of wheelchair.
2. If circuit breaker turned off automatically or manually, move circuit breaker switch towards FRONT of wheelchair to turn on power supply again.

6.2 Batteries

Power is supplied by two 12 V batteries. The batteries are maintenance-free and only need regular charging.

In the following, you find information on how to charge, handle, transport, store, maintain, and use batteries.

6.2.1 General Information on Charging

New batteries should always be fully charged once before their first use. New batteries will be at their full capacity after having run through approx. 10 - 20 charging cycles (break-in period). This break-in period is necessary to fully activate the battery for maximum performance and longevity. Thus, range and running time of your mobility device could initially increase with use.

Gel/AGM lead acid batteries do not have a memory effect as NiCd batteries.

6.2.2 General Instructions on Charging

Follow the instructions listed below to ensure safe use and longevity of the batteries:

- Charge 18 hours prior to initial usage.
- We recommend charging the batteries daily after every discharge even after partly discharge, as well as each night over night. Depending on the level of discharge, it can take up to 12 hours until the batteries are fully charged again.
- When the battery indicator reached the red LED range, charge the batteries for 16 hours minimum, neglecting the charge complete display!
- Try to provide a 24 hour charge once a week to make sure that both batteries are fully charged.
- Do not cycle your batteries at a low state of charge without regularly recharging them fully.
- Do not charge your batteries under extreme temperatures. High temperatures above 30 °C are not recommended for charging as well as low temperatures below 10 °C.
- Use only charging devices in Class 2. This class of chargers may be left unattended during charging. All charging devices which are supplied by Invacare comply with these requirements.
- You cannot overcharge the batteries when using the charger supplied with your mobility device, or a charger that has been approved by Invacare.

- Protect your charger from sources of heat such as heaters and direct sunlight. If the battery charger overheats, charging current will be reduced and the charging process delayed.

6.2.3 Charging Batteries

Refer to the user manuals for your remote and battery charger for the position of the charging socket and further information about charging the batteries.



WARNING!

Risk of explosion and destruction of batteries if the wrong battery charger is used

- Only ever use the battery charger supplied with your mobility device, or a charger that has been approved by Invacare.



WARNING!

Risk of electric shock and damage to the battery charger if it gets wet

- Protect the battery charger from water.
- Always charge in a dry environment.



WARNING!

Risk of short circuit and electric shock if the battery charger has been damaged

- Do not use the battery charger if it has been dropped or damaged.



WARNING!

Risk of electric shock and damage to the batteries

- NEVER attempt to recharge the batteries by attaching cables directly to the battery terminals.



WARNING!

Risk of fire and electric shock if a damaged extension cable is used

- Only ever use an extension cable if it is absolutely necessary. In case you must use one, make sure it is in good condition.



WARNING!

Risk of injury if using the mobility device during charging

- DO NOT attempt to recharge the batteries and operate the mobility device at the same time.
- DO NOT sit in the mobility device while charging the batteries.

1. Switch off mobility device.
2. Connect battery charger to charger socket.
3. Connect battery charger to power supply.

6.2.4 Disconnecting Mobility Device After Charging

1. Once charging is complete, first disconnect battery charger from power supply, then disconnect plug from remote.

6.2.5 Storage and Maintenance

Follow the instructions listed below to ensure safe use and longevity of the batteries:

- Always store the batteries fully charged.
- Do not leave the batteries in a low state of charge for an extended length of time. Charge a discharged battery as soon as possible.
- In case your mobility device is not used for a longer period of time (that is more than two weeks), the batteries must be charged at least once a month to maintain a full charge and always be charged before use.
- Avoid hot and cold extremes when storing. We recommend to store batteries at a temperature of 15 °C.
- Gel and AGM batteries are maintenance-free. Any performance issues should be handled by a properly trained mobility device technician.

6.2.6 Instructions on Using Batteries



CAUTION!

Risk of damaging the batteries.

- Avoid ultra-deep discharges and never drain your batteries completely.

- Pay attention to the Battery Charge Indicator! Charge the batteries when the Battery Charge Indicator shows that battery charge is low.
How fast the batteries discharge depends on many circumstances, such as ambient temperature, condition of the surface of the road, tire pressure, weight of the driver, way of driving and utilisation of lighting, if fitted.

- Try to charge the batteries always before you reach the red LED range.
The last LED (one red) means a remaining capacity of about 20 %.
- Driving with flashing red LED's means an extreme stress for the battery and should be avoided under normal circumstances.
- When only one red LED is flashing, the Battery Safe feature is enabled. From this time, speed and acceleration is reduced drastically. It will allow you to move the mobility device slowly out of a dangerous situation before the electronic finally cuts off. This is deep discharging and should be avoided.
- Be aware that for temperatures below 20 °C, the nominal battery capacity starts to decline. For example, at -10 °C the capacity is reduced to about 50 % of the nominal battery capacity.
- To avoid damaging the batteries, never allow them to be fully discharged. Do not drive on heavily discharged batteries if it is not absolutely necessary, as this will strain the batteries unduly and shorten their life expectancy.
- The earlier you recharge the batteries, the longer they live.

- The depth of discharge affects the cycle life. The harder a battery has to work, the shorter is its life expectancy. Examples:

- One deep discharge stresses the same as 6 normal cycles (green /orange display off).
- The battery life is about 500 cycles at 80 % discharge (first 4 LED off), or about 5000 cycles at 10 % discharge (one LED off).



The number of LED can vary depending on the remote type.

- Under normal operation, once a month the battery should be discharged until all green and orange LED are off. This should be done within one day. A 16 hour charge afterwards is necessary as reconditioning.

6.2.7 Transporting Batteries

The batteries supplied with your mobility device are not hazardous goods. This classification is based on the German GGVS Hazardous Goods Road Transport Ordinances, and the IATA/DGR Hazardous Goods Rail Transport / Air Transport Ordinances. Batteries may be transported without restrictions, whether by road, rail or by air. Individual transport companies have, however, guidelines which can possibly restrict or forbid certain transport procedures. Please ask the transport company regarding each individual case.

6.2.8 General Instructions on Handling Batteries

- Never mix and match different battery manufactures or technologies, or use batteries that do not have similar date codes.
- Never mix gel with AGM batteries.

- The batteries reach their end of life when the drive range is significantly smaller than usual. Contact your provider or service technician for details.
- Always have your batteries installed by a properly trained mobility device technician or a person with adequate knowledge. They have the necessary training and tools to do the job safely and correctly.

6.2.9 Handling Damaged Batteries Correctly



CAUTION!

Corrosion and burns from acid leakage if batteries are damaged

- Remove clothes that have been soiled by acid immediately.

After contact with skin:

- Immediately wash affected area with lots of water.

After contact with eyes:

- Immediately rinse eyes under running water for several minutes; consult a physician.

- Always wear safety goggles and appropriate safety clothing when handling damaged batteries.
- Place damaged batteries in an acid-resistant receptacle immediately after removing them.
- Only ever transport damaged batteries in an appropriate acid-resistant receptacle.
- Wash all objects that have come into contact with acid with lots of water.

Disposing of Dead or Damaged Batteries Correctly

Dead or damaged batteries can be given back to your provider or directly to Invacare.

7 Transport

7.1 Transport — General Information



WARNING!

Risk of death or serious injury to the mobility device user and potentially any other nearby occupant of the vehicle, if a mobility device is secured using a tie-down system available from a third party supplier and the unladen weight of the mobility device exceeds the maximum weight for which the tie-down system is certified

- Make sure the weight of the mobility device does not exceed the weight for which the tie-down system is certified. Consult the tie-down manufacturer's documentation.
- If you are unsure how much your mobility device weighs, then you must have it weighed using calibrated scales.



WARNING!

Risk of Injury or Damage

If the mobility device is fitted with a tray or other auxiliary equipment this could break free during transfer to a vehicle and cause damage or injury to users in the event of a collision.

- When possible, other auxiliary mobility device equipment should be either secured to the mobility device or removed from the mobility device and secured in the vehicle during travel.
- If a tray is fitted, always remove it before transporting the mobility device.

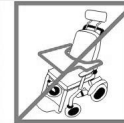

NOTICE!

- The vehicle should have the floor strength to take the combined weight of the occupant, the mobility device and accessories / options.

7.2 Transferring Mobility Device to Vehicle



WARNING!

Mobility device is at risk of tipping over if transferred to a vehicle while user is still seated in mobility device

- Transfer mobility device without user whenever possible.
- If mobility device with user must be transferred to vehicle using a ramp, ensure that ramp does not exceed rated slope.
- If mobility device must be transferred to vehicle using a ramp that does exceed rated slope, a winch must then be used. An attendant can then safely monitor and assist transfer process.
- Alternatively, a platform lift may be used.
- Ensure that total weight of mobility device including user does not exceed maximum permitted total weight for ramp or platform lift.
- Mobility device should always be transferred to vehicle with backrest in upright position, seat lifter lowered and tilt in upright position (refer to *5.6 Driving up and down Gradients, page 33*).



WARNING!

Risk of injury and damage to mobility device and vehicle

Risk of tipping over or uncontrolled movements of mobility device if transferred to vehicle using a ramp that exceeds rated slope.

- Transfer mobility device to vehicle without user.
- An attendant must assist transfer process.
- Ensure that all carer fully understand manual of ramp and winch.
- Ensure that winch is suitable for your mobility device.
- Use only suitable tie-down points. Do not use removable or movable components of mobility device as tie-down points.



WARNING!

Risk of injury and damage to mobility device

If mobility device must be transferred to vehicle via a lift, when remote is turned on, there is a risk that device may act erratically and fall off lift.

- Before transferring mobility device via lift, turn off product and disconnect either bus cable from remote or batteries from system.

1. Drive or push your mobility device into transport vehicle using suitable ramp.

7.3 Use Mobility Device as Vehicle Seat

Not every mobility device does automatically have the permission to be used as a vehicle seat. The following

labels explain whether the mobility device can be used as a vehicle seat or not.

If the mobility device may NOT be used as a vehicle seat, this is identified by the following label:



If the mobility device can be used as a vehicle seat, the tie-down points are identified by the following label:



In order to use a mobility device as a vehicle seat, it must be fitted with tie-down points to enable anchoring in the motor vehicle. These accessories / options may be included in the standard scope of mobility device order and delivery in some countries (UK for example), but may also be obtained from Invacare as an option in other countries.

The following information is only relevant if your mobility device can be used as a vehicle seat:

The mobility device may be used as a vehicle seat in connection with an anchoring system that has been checked and approved in accordance with ISO 10542. The transporting vehicle must be professionally converted to anchor the mobility device. Contact your vehicle's manufacturer for more information.



If possible, the user should always leave the mobility device to use a vehicle seat and the vehicle-manufacturer-installed restraint system. The unoccupied mobility device should be stored in a cargo area or secured in the vehicle during travel.

A mobility device permitted as vehicle seat has undergone a crash test in accordance to ISO 7176–19 for use in road vehicles and meets the requirements for forward facing transport and head on collisions. The crash test dummy was secured using pelvic and upper body safety belts. Both types of safety belt should be used in order to minimize the risk of injuries to head or upper body.



Invacare tests with a tie-down system from BraunAbility® Safety Systems.

- Contact BraunAbility for more information on how to obtain such a system for your country and vehicle type. For information concerning the curb weight, refer to *10 Technical Data, page 63*.

**WARNING!****Risk of Serious Injury**

The mobility device has been designed and tested to conform to the requirements of ISO 7176-19 for use only as forward-facing seat in a motor vehicle.

The mobility device has been dynamically tested in a forward-facing orientation with the ATD (anthropomorphic test device, crash-test dummy) restrained by a three-point belt restraint.

If any of the instructions is not followed, serious injuries or damage can occur in an event of a collision:

- Alterations or substitutions shall not be made to the mobility device securement points or to structural and frame parts or components since this can affect the crashworthiness of the mobility device, and it can also change the performance of the mobility device in normal use. If it is considered necessary to make these kinds of alterations, Invacare shall be consulted.
- Only use spill-proof sealed batteries approved by Invacare.
- It is imperative that the mobility device is inspected by an authorised provider for determination whether the mobility device is suitable for reuse after any type of vehicle collision.

**CAUTION!****There is a risk of injury if the mobility device is not properly secured during use as a vehicle seat**

- If possible, the user should always leave the mobility device to use a vehicle seat and the safety belts provided with the vehicle.
- The mobility device should always be anchored facing in the transport vehicle's intended direction of travel.
- The mobility device must always be secured in accordance with the mobility device and anchoring system manufacturers' operating manual.
- Always remove and secure any accessories / options fixed to the mobility device such as chin controls or tables.
- If your mobility device is equipped with an angle adjustable backrest, then it must be placed in an upright position.
- Fully lower elevated legrests, if fitted.
- Fully lower the seat lifter, if fitted.

7.3.1 Anchoring Mobility Device Used as Vehicle Seat

The mobility device is fitted with tie-down points. Snap hooks or belt loops can be used for fixation.

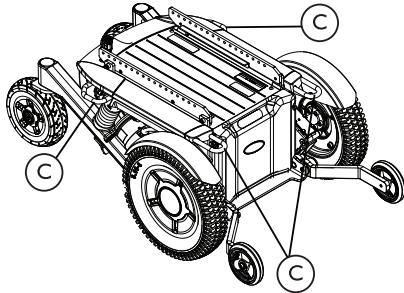

Fig. 7-1 Base Tie-Down Points – All Mobility Devices

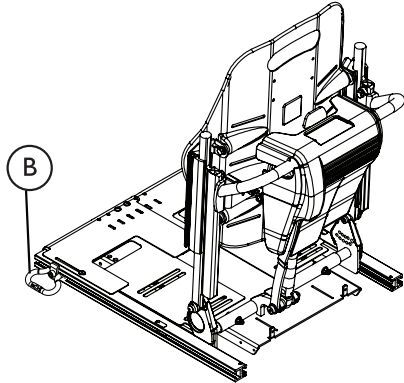

Fig. 7-2 Seat Tie-Down Points – Seating Systems with Lifter (Ultra Low Maxx seat serves as an example)

1. Secure mobility device with tie-down system belts at following locations:
 - a. All Mobility Devices — four tie-down points © on mobility device base (two at front and two at rear).
 - b. Seating systems with Lifter — two additional tie-down points © on each side of seat at front of seat rails.
2. Secure mobility device by tensioning belts in accordance with tie-down system manufacturer's user manual.

7.3.2 Securing User in Mobility Device

The crash test dummy was secured using pelvic and upper body safety belts. Both types of safety belt should be used in order to minimize the risk of injuries to head or upper body.



CAUTION!

Risk of injury if the user is not properly secured within the mobility device

- Safety restraint devices must only be used when the wheelchair user’s weight is 23 Kg or more.
- Even if the mobility device is fitted with a posture belt or any other mobility device integrated belt system, this is no substitute for a proper safety belt which complies with ISO 10542 in the transport vehicle. Always use the safety belt installed in the transport vehicle.
- Safety belts must be pulled as tightly as possible without causing the user discomfort.
- Safety belts must not be positioned while twisted.
- Ensure that the third seat belt anchorage point is not fixed directly to the vehicle floor, but to one of the vehicle uprights.
- Both pelvic and upper torso restraint belts must be used to restrain the occupant to reduce the possibility of head and chest impacts with the vehicle components. They shall be used together only as designed for.



CAUTION!

Risk of injury if the user is not properly secured within the mobility device (continued)

- Any wheelchair anchored occupant restraint i.e. 3-point belt, harness or postural supports (lap straps, lap belts) should not be used or relied on for occupant restraint in a moving vehicle. Always use a vehicle anchored and certified occupant restraint system instead.
- Care should be taken when applying the occupant restraint to position the seatbelt buckle so that the release button will not be contacted by mobility device components during transport and during a crash
- Safety belts must be in contact with the user's body. They must not be held at a distance from the user's body using parts of the mobility device such as armrests or wheels.



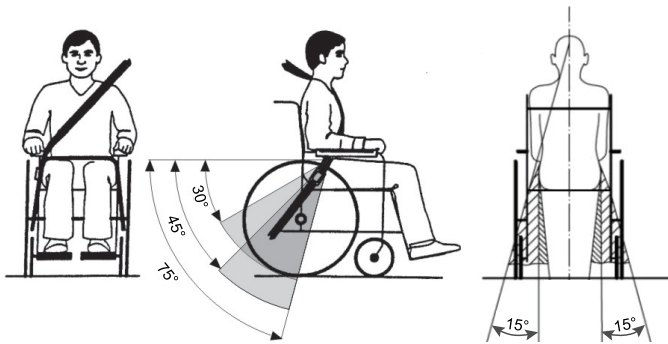

Fig. 7-3

The pelvic belt should be positioned in the area between the user's pelvis and thighs so that it is unobstructed and not too loose. The ideal angle of the pelvic belt to the horizontal is between 45° and 75°. The maximum permissible angle is between 30° and 75°. The angle should never be less than 30°!

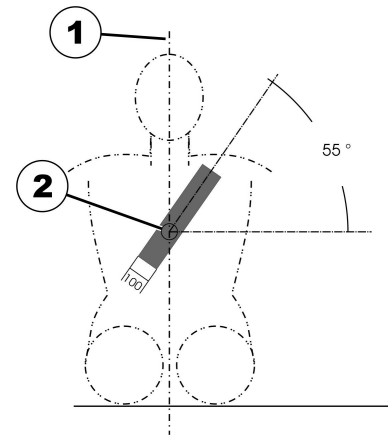

Fig. 7-4

The safety belt installed in the transporting vehicle should be applied as shown in the illustration above.

- 1) Center line of the body
- 2) Center of the sternum

**CAUTION!**

Risk of injury during use of the mobility device as a vehicle seat if a headrest is wrongly adjusted or not installed

This can cause the neck to be hyperextended during collisions.

- A headrest must be installed. The headrest optionally supplied for this mobility device by Invacare is perfectly suitable for use during transport.
- The headrest must be adjusted to the user's ear height.

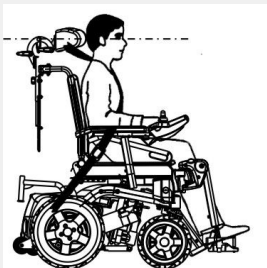

7.4 Transporting Mobility Device Without Occupant

**CAUTION!**

Risk of injury

- If you are unable to fasten your mobility device securely in a transport vehicle, Invacare recommends that you do not transport it.

Your mobility device may be transported without restrictions, whether by road, rail or by air. Individual transport companies have, however, guidelines which can possibly restrict or forbid certain transport procedures. Please ask the transport company regarding each individual case.

- Before transporting your mobility device, make sure the motors are engaged and that the remote is switched off. Invacare strongly recommends that you additionally disconnect or remove the batteries. Refer to Removing the batteries.
- Invacare strongly recommends securing the mobility device to the floor of the transporting vehicle.

7.5 Dahl Docking System

If a mobility device is equipped with a Dahl Docking System adapter plate, the following label appears on the backrest of the mobility device. The value on the label explains the ground clearance of the mobility device, fitted with a Dahl Docking system adapter plate.

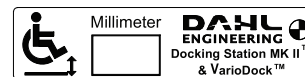

Fig. 7-5

**WARNING!****Risk of Death, Serious Injury or Damage**

If the mobility device is not secured in a forward facing direction in the Dahl Docking station, death, serious injury or damage may occur.

- The wheelchair should be secured in a forward facing direction. This wheelchair is tested to ISO 7176-19, for use in road vehicles and meets the requirements for forward facing transport and head on collisions. The wheelchair has not been tested for other directions in a vehicle.

Installation of Dahl Docking Stations in Vehicles

Only professional companies in the business of converting or building wheelchair accessible vehicles can order the docking system from Dahl Engineering. A qualified and experienced technician must carry out the installation. Dahl Engineering can provide vehicle specific installation instructions for a large range of vehicles, which must be respected by the fitter. Please contact Dahl Engineering for further information about approved vehicles and fitting positions. Dahl Engineering contact details are available at: www.dahlengineering.dk.



To retrofit a mobility device with a Dahl Docking system, it is imperative, that the mobility device is equipped with the correct adapter plate. This adapter plate must be threaded to fix the lock plate of the Dahl Docking system underneath the mobility device.

The maximum payload with the Dahl Docking system is 136 kg.

The maximum weight of the mobility device must not exceed 200 kg.

For more information about retrofitting, contact your provider.



The description of how to install the Dahl Docking system to maintain the CE-marking of the product is contained in the service manual of this mobility device. The service manual can be ordered from Invacare.



For more information about spare parts, accessory / option part installation in vehicles and maintenance of the Dahl Docking system, contact Dahl Engineering.



Positioning the occupant restraint when using it with the Dahl Docking system only

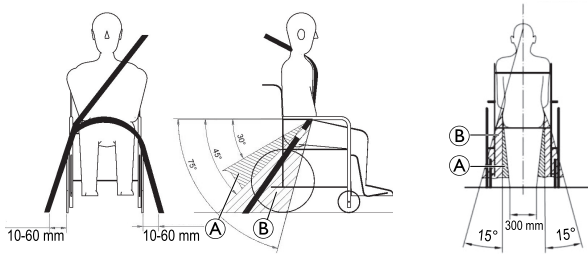

When using mobility device with a Dahl Docking system, the floor anchorage points for the occupant restraint system should be located 10 – 60 mm outside wheels on each side. The pelvic belt must be worn low across the front of the pelvis so that the angle of the pelvic belt is within the preferred zone (A) of 30° to 45° as shown. A steeper angle within the optional zone (B), 45° to 75° is desirable, but never exceeding 75°.

Components of Dahl Docking System

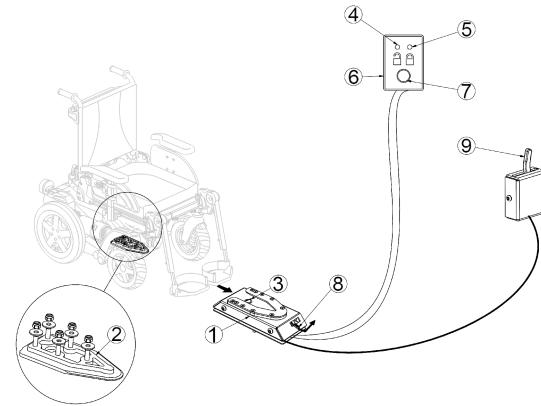

Fig. 7-6

- (1) Dahl Docking station
- (2) Lock plate and 8 mm spacer
- (3) Locking pin
- (4) Red LED
- (5) Green LED
- (6) Control panel
- (7) Release button
- (8) Manual emergency release lever
- (9) Manual operating lever (optional)

Dahl Engineering offers two Dockings systems, the MK II (Dahl No. 501750), and a power height adjustable called Dahl VarioDock (Dahl No. 503600).

Locking in Dahl Docking Station



WARNING!

Risk of Death, Serious Injury or Damage

If the vehicle is moved while the mobility device is not correctly secured in the Dahl Docking station, death, serious injury or damage may occur.

- Do not move the vehicle while the mobility device is maneuvered into position in the Dahl Docking station.
- Do not move the vehicle if mobility device and user are not correctly secured.
- Do not move the vehicle if the warning tone sounds and/or if the red LED in the control panel flashes or is lit.

1. Maneuver mobility device slowly and in straight direction over Dahl Docking station (1).

View from back

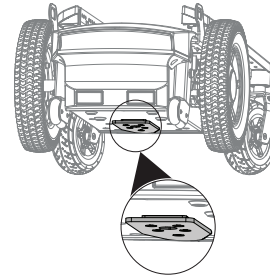

Fig. 7-7 AVIVA RX

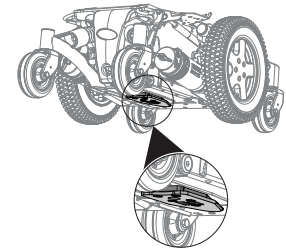

Fig. 7-8 TDX SP2

View from front

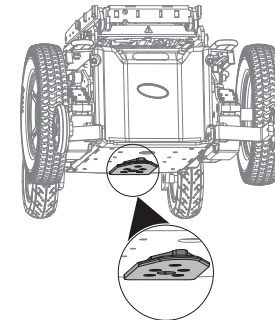



Fig. 7-9 AVIVA FX

Lock plate (2) underneath mobility device helps to guide mobility device into Dahl Docking station.

2. If lock plate is fully engaged in Dahl Docking station, locking pin (3) automatically secures lock plate.

3. Dahl Docking station is equipped with control switch that indicates if lock plate is correctly secured in Dahl Docking station.
As soon as lock plate comes in contact with locking pin, warning tone sounds (high-pitched howl) and red LED in control panel (6) lights up until lock plate is either fully engaged or mobility device is removed from Dahl Docking station.
4. When mobility device is properly secured, warning tone ceases, red LED goes out and green LED lights up.
5. Buckle up with seat belt of vehicle.

 Always check before moving the vehicle if lock plate is properly engaged in the Dahl Docking station by trying to reverse the mobility device out of the Dahl Docking station. It must not be possible to reverse out of the Dahl Docking station without pressing the red release button (7) in the control panel.

Unlocking from Dahl Docking Station

1. Stop and prevent vehicle from moving.
2. Remove seat belt.
3. Move mobility device forward to release pressure on locking pin.
4. Press red release button (7) in control panel.
Locking pin is released for approx. five seconds, after which locking pin is automatically locked again.
5. Move mobility device away from Dahl Docking station within five-second period.
Do not attempt to reverse mobility device until red LED, which indicates unlock position, lights up.

 Attempting to reverse the mobility device before the red LED lights up, results in blocking the Dahl Docking station's locking mechanism, which makes it impossible to reverse. If this happens, repeat unlocking procedure.

Manual Unlocking in Case of Electrical Failure

 The following instructions require the help of an attendant.

1. Move mobility device forward to release pressure on locking pin.
 2. Push manual emergency release lever (8) to one side and hold it there, while mobility device moves away.
 3. A cable-activated manual operating lever (9) can also be fitted (accessory / option).
Push lever to one side and hold it there, while mobility device moves away.
-  If the manual unlocking procedure fails, an emergency release tool made from red plastic comes with each Dahl Docking station.

1. Move mobility device forward to release pressure on locking pin.

2.



Fig. 7-10

Place emergency release tool in gap between locking plate and Dahl Docking station.

3.



Fig. 7-11

Push emergency release tool and mobility device forward until locking pin has been forced down.

4. Move mobility device away from Dahl Docking station.

8 Maintenance

8.1 Maintenance Introduction

The term “Maintenance” means any task performed to ensure that a medical device is in good working order and ready for use as intended. Maintenance encompasses different areas, such as everyday care and cleaning, inspection checks, repair tasks and refurbishment.



It is recommended, to have your mobility device checked once a year by an authorised Invacare provider to maintain its driving safety and roadworthiness.

8.2 Inspection Checks

The following tables list inspection checks that should be performed by the user and their intervals. If the mobility device fails to pass one of the inspection checks, refer to the chapter indicated or contact your authorised Invacare provider. A more comprehensive list of inspection checks and instructions for maintenance work can be found in the service manual for this device, which can be obtained from Invacare. That manual, however, is intended to be used by trained and authorised service technicians, and describes tasks which are not intended to be performed by the user.

8.2.1 Before Each Use of Mobility Device

Item	Inspection Check	If Inspection is not Passed
Screwed connections	Check all connections, such as backrests and wheels, for tight fit.	Contact your provider.
Signal horn	Check for correct function.	Contact your provider.
Lighting system	Check that all lights, such as turn indicators, head lamps and tail lights, are functioning correctly.	Contact your provider.
Battery box locking system	Check to ensure that the battery box locking system is functioning correctly. Locking pins must be completely engaged in the holes provided for them (see chapter 7.4 <i>Transporting Mobility Device Without Occupant</i> , page 50).	Contact your provider.
Batteries	Make sure the batteries are charged. See the user manual provided with your remote for a description of the battery charge indicator.	Charge the batteries (see chapter 6.2.3 <i>Charging Batteries</i> , page 39).

8.2.2 Weekly

Item	Inspection check	If inspection is not passed
Armrests/side parts	Check that armrests are firmly attached in their holders and do not wobble.	Tighten the screw or clamping lever that holds the armrest (see chapter <i>Adjustment Possibility for Remote</i>). Contact your provider.
Tires (pneumatic)	Check that the tires are undamaged.	Contact your provider.
	Check that the tires are inflated to the correct pressure.	Inflate the tire to the correct pressure (see chapter <i>8.3 Wheels and Tyres, page 58 and 10 Technical Data, page 63</i>).
Tires (puncture-proof)	Check that the tires are undamaged.	Contact your provider.
Antitippers	Check that antitippers are firmly attached and do not wobble. Check that the spring clips of the antitippers are in good order and secure the antitippers correctly.	Contact your provider.

8.2.3 Monthly

Item	Inspection Check	If Inspection is not Passed
All upholstered parts	Check for damage and wear.	Contact your provider.
Removable legrests	Check whether legrests can be fixed securely and whether loosening mechanism is properly operable.	Contact your provider.
	Check that all adjustment options function properly.	Contact your provider.
Castors	Check that castors rotate and swivel freely.	Contact your provider.

Item	Inspection Check	If Inspection is not Passed
Drive wheels	Check that drive wheels rotate without wobbling. It is easiest to have someone stand behind mobility device and observe drive wheels as you drive away from them to do this.	Contact your provider.
Electronics and connectors	Check all cables for damage and all connecting plugs for snug fit.	Contact your provider.

8.3 Wheels and Tyres

Dealing With Wheel Damages

In case of having a damaged wheel, contact your provider. Because of safety reasons do not have the wheel repaired by yourself or by not authorised persons.

Dealing With Pneumatic Tyres



Risk of damage to tyre and rim

- Never drive with too low tyre pressure, this could result in damage to tyre.
If tyre pressure is exceeded rim could be damaged.
– Inflate tyres to recommended pressure.



Use tyre gauge to check pressure.

Check weekly that the tyres are inflated to the correct pressure, see chapter 8.2 *Inspection Checks*, page 56.

For recommended tyre pressure see inscription on tyre/rim or contact Invacare. Compare table below for conversion.

psi	bar
22	1.5
23	1.6
25	1.7
26	1.8
28	1.9
29	2.0
30	2.1
32	2.2
33	2.3
35	2.4
36	2.5
38	2.6
39	2.7
41	2.8
44	3.0

8.4 Short-Term Storage

In case a serious fault is detected, a number of safety mechanisms are built into your mobility device and will protect it. The power module prevents your mobility device from driving.

When the mobility device is in such a condition and while waiting for repair:

1. Switch off power.
2. Disconnect the batteries.
Depending on the mobility device model, you can either remove the battery packs or disconnect the batteries from the power module. Refer to the corresponding chapter about disconnecting the batteries.
3. Contact your provider.

8.5 Long-Term Storage

In case your mobility device is not used for a longer period of time, you need to prepare it for storage to ensure a longer life for your mobility device and batteries.

Storing Mobility Device and Batteries

- We recommend to store the mobility device at a temperature of 15 °C, avoid hot and cold extremes when storing to ensure a long service life of the product and batteries.
- The components are tested and approved for greater temperature ranges as detailed below:
 - Allowable temperature range to store the mobility device is -40° up to 65 °C.
 - Allowable temperature range to store batteries is -25° up to 65 °C.

- Even not being used, batteries discharge themselves. Best practice is to disconnect the battery supply from the power module if storing the mobility device longer than two weeks. Depending on the mobility device model, you can either remove the battery packs or disconnect the batteries from the power module. Refer to the corresponding chapter about disconnecting the batteries. If in doubt which cable to disconnect, contact your provider.
- Batteries should always be fully charged before storing.
- If storing the mobility device longer than four weeks, check the batteries once a month and recharge as needed (before gauge reads half full) to avoid damage.
- Store in a dry, well-ventilated environment protected from outer influences.
- Slightly overinflate pneumatic tyres.
- Position the mobility device on flooring that is not discoloured by contact with tyre rubber.

Preparing Mobility Device for Use

- Re-connect the battery supply to the power module.
- The batteries must be charged before use.
- Have the mobility device checked by an authorised Invacare provider.

8.6 Cleaning and Disinfection

8.6.1 General Safety Information



CAUTION!

Risk of Contamination

- Take precautions for yourself and use appropriate protective equipment.



CAUTION!

Risk of Electric Shock and Product Damage

- Switch off the device and disconnect from mains, if applicable.
- When cleaning electronic components consider their protection class regarding water ingress.
- Make sure that no water splashes to the plug or the wall outlet.
- Do not touch the power socket with wet hands.



NOTICE!

Wrong fluids or methods can harm or damage the product.

- All cleaning agents and disinfectants used must be effective, compatible with one another and must protect the materials they are used to clean.
- Never use corrosive fluids (alkalines, acid etc.) or abrasive cleaning agents. We recommend an ordinary household cleaning agent such as dishwashing liquid, if not specified otherwise in the cleaning instructions.
- Never use a solvent (cellulose thinner, acetone etc.) that changes the structure of the plastic or dissolves the attached labels.
- Always make sure that the product is completely dried before taking into use again.



For cleaning and disinfection in clinical or long-term care environments, follow your in-house procedures.

8.6.2 Cleaning Intervals



NOTICE!

Regular cleaning and disinfection enhance smooth operation, increases the service life and prevents contamination.

Clean and disinfect the product:

- regularly while in use,
- before and after any service procedure,
- when it has been in contact with any body fluids,
- before using it for a new user.

8.6.3 Cleaning



NOTICE!

- The product does not tolerate cleaning in automatic washing plants, with high-pressure cleaning equipment or steam.



NOTICE!

- Dirt, sand and seawater can damage the bearings and steel parts can rust if the surface is damaged.
- Only expose the wheelchair to sand and seawater for short periods and clean it after every trip to the beach.
- If the wheelchair is dirty, wipe off the dirt as soon as possible with a damp cloth and dry it carefully.

1. Remove any installed optional equipment (only optional equipment which does not require tools).
2. Wipe down the individual parts using a cloth or soft brush, ordinary household cleaning agents (pH = 6 - 8) and warm water.
3. Rinse the parts with warm water.
4. Thoroughly dry the parts with a dry cloth.



Car polish and soft wax can be used on painted metal surfaces to remove abrasions and restore gloss.

Cleaning upholstery

For cleaning upholstery refer to the instructions on the labels of the seat, cushion and backrest cover.



If possible, always overlap hook and loop strips (the self-gripping parts) when washing, to minimize lint and thread build-up on hook strips and prevent damage to upholstery fabric by these.

8.6.4 Disinfection Instructions

Method: Follow the application notes for the used disinfectant and wipe-disinfect all accessible surfaces.

Disinfectant: Ordinary household disinfectant.

Drying: Allow the product to air-dry.

9 After Use

9.1 Reconditioning

This product is suitable for reuse. To recondition the product for a new user, carry out the following actions:

- Inspection according to service plan. See service manual, available from Invacare.
- Cleaning and disinfection. Refer to *8 Maintenance, page 56*.
- Adaptation to the new user. Refer to *Setup*.

Make sure that the user manual is handed over with the product.

If any damage or malfunction is detected, do not reuse the product.

9.2 Disposal



WARNING!

Environmental Hazard

Device contains batteries.

This product may contain substances that could be harmful to the environment if disposed of in places (landfills) that are not appropriate according to legislation.

- DO NOT dispose of batteries in normal household waste.
- DO NOT throw batteries into a fire.
- Batteries MUST be taken to a proper disposal site. The return is required by law and free of charge.
- Only dispose of discharged batteries.
- Cover terminals of lithium batteries prior to disposal.
- For information on the battery type see battery label or chapter *10 Technical Data, page 63*.

Be environmentally responsible and recycle this product through your recycling facility at its end of life.

Disassemble the product and its components, so the different materials can be separated and recycled individually.

The disposal and recycling of used products and packaging must comply with the laws and regulations for waste handling in each country. Contact your local waste management company for information.

10 Technical Data

10.1 Technical Specifications

The technical information provided hereafter applies to a standard configuration or represents maximum achievable values. These can change if accessories / options are added. The precise changes to these values are detailed in the sections for the respective accessories / options.

Note that there may be values in this list, which are not relevant to your product, since this list applies to all available models (on the date of printing). If not otherwise stated, each value in this list refers to all models of the product.

The models and configurations available in your country can be found in the country-specific sales documents.



Note that in some cases the measured values may vary up to ± 10 mm.

Permissible Operating and Storage Conditions	
Temperature Range for Operation According to ISO 7176-9	<ul style="list-style-type: none"> -25 °C – +50 °C
Recommended Storage Temperature	<ul style="list-style-type: none"> +15 °C
Temperature Range for Storage According to ISO 7176-9	<ul style="list-style-type: none"> -25 °C – +65 °C with batteries -40 °C – +65 °C without batteries

Electrical System	
Motors	<ul style="list-style-type: none"> 2 x 324 W 2 x 340 W (12 km/h)
Batteries ¹	<ul style="list-style-type: none"> 2 x 12 V / 73.5 Ah (C20) / 63 Ah (C5) sealed VRLA gel
Main Fuse	<ul style="list-style-type: none"> 63 A
Degree of Protection	IPX4 ²

Charging Device	
Output Current	<ul style="list-style-type: none"> • 8 A • 10 A
Output Voltage	<ul style="list-style-type: none"> • 24 V nominal

Drive Wheel Tyres	
Tyre Type	<ul style="list-style-type: none"> • 14 inch puncture-proof, pneumatic
Tyre Pressure	<p>The recommended maximum tyre pressure in bar or kpa is marked on the side wall of the tyre or the rim. If more than one value is listed, the lower one in the corresponding units applies.</p> <p>(Tolerance = -0.3 bar, 1 bar = 100 kpa)</p>

Castor Tyres	
Tyre Type	<ul style="list-style-type: none"> • 8 inch puncture-proof
Tyre Pressure	<p>The recommended maximum tyre pressure in bar or kpa is marked on the side wall of the tyre or the rim. If more than one value is listed, the lower one in the corresponding units applies.</p> <p>(Tolerance = -0.3 bar, 1 bar = 100 kpa)</p>

Driving Characteristics	
Speed	<ul style="list-style-type: none"> • 6 km/h • 10 km/h • 12 km/h
Min. Braking Distance:	
Normal Operation	<ul style="list-style-type: none"> • 1000 mm (6 km/h) • 2100 mm (10 km/h) • 2900 mm (12 km/h)
Emergency Operation	<ul style="list-style-type: none"> • 600 mm (6 km/h) • 1800 mm (10 km/h) • 2130 mm (12 km/h)
Max. Climbable Obstacle Height	<ul style="list-style-type: none"> • Forward 83 mm • Reverse 64 mm
Rated Slope ³ :	
Modulite without Lifter	<ul style="list-style-type: none"> • 9°
Modulite with Lifter	<ul style="list-style-type: none"> • 9°
Max. Slope With Engaged Parking Brakes	<ul style="list-style-type: none"> • 12.6° (uphill) • 14.1° (downhill)
Lateral Dynamic Stability:	

Driving Characteristics		
	Min. Diameter for Turning in Circles at Max. Speed	<ul style="list-style-type: none"> • 5300 mm
	Stable While Turning Suddenly	Yes
Continuous Driving Distance Range in Accordance with ISO 7176-4 ⁴ :		
	Modulite	<ul style="list-style-type: none"> • 35.5 km (6 km/h) • 35.6 km (10 km/h) • 27.3 km (12 km/h)
Manoeuvring Distance Range in Accordance with ISO 7176-4 ⁴ :		
	Modulite	<ul style="list-style-type: none"> • 11.2 km (6 km/h) • 10.8 km (10 km/h) • 8.1 km (12 km/h)
	Turning Diameter	<ul style="list-style-type: none"> • 1240 mm (Modulite)
	Pivot Width	<ul style="list-style-type: none"> • 1240 mm
	Required Width of Angled Corridor	<ul style="list-style-type: none"> • 785 mm
	Required Doorway Entry Depth	<ul style="list-style-type: none"> • 1439 mm
	Required Corridor Width for Side Opening	<ul style="list-style-type: none"> • 842 mm

Dimensions According to ISO 7176–15	Modulite
Seat-to-Floor Height ⁵ :	
With Tilt Module	<ul style="list-style-type: none"> • 430 mm • 470 mm • 495 mm • 520 mm
With Lifter / Tilt Module	<ul style="list-style-type: none"> • 430 – 730 mm • 470 – 770 mm • 495 – 795 mm • 520 – 820 mm
Max. Total Height	<ul style="list-style-type: none"> • 1035 – 1370 mm
Max. Total Width (depending on Seat Width and Base Width)	<ul style="list-style-type: none"> • 618 mm
Total Length (With center-mounted legrest)	<ul style="list-style-type: none"> • 1205 mm
Stowage Length	<ul style="list-style-type: none"> • 1070 mm
Stowage Width	<ul style="list-style-type: none"> • 604 mm
Stowage Height	<ul style="list-style-type: none"> • 772 mm
Ground Clearance	<ul style="list-style-type: none"> • 86 mm

Kerb Weight ⁶	Modulite
	<ul style="list-style-type: none"> • 105 – 185.2 kg

Component Weights	
73.5 Ah Batteries	<ul style="list-style-type: none"> • approx. 23 kg per battery

Payload	Modulite
Max. occupant mass	<ul style="list-style-type: none"> • 136 kg

Axle Loads	
Max. Front Axle Load	<ul style="list-style-type: none"> • 259 kg
Max. Rear Axle Load	<ul style="list-style-type: none"> • 103 kg

- Usable battery capacity depending on the discharge time.
C20: Discharge over a period of 20 hours.
C5: Discharge over a period of 5 hours.
- IPX4 classification means that the electrical system is protected against spray water.
- Static stability downhill, uphill, and sideways according to ISO 7176-1 = 9° (15.8 %)
Dynamic stability according to ISO 7176-2 = 6° (10.5 %)
- Note: The drive range of a mobility device is strongly influenced by external factors, such as the speed setting of the wheelchair, the charging state of the batteries, surrounding temperature, local topography, road surface characteristics, tyre pressure, weight of user, drive style and use of batteries for lighting, servos etc.

The specified values are theoretical maximum achievable values measured according to ISO 7176-4.
- Measured without seat cushion
- The actual kerb weight depends on the fittings your mobility device has been supplied with. Every Invacare mobility device is weighed when leaving the works. Refer to the nameplate for the kerb weight (including batteries) measured.

11 Service

11.1 Inspections Performed

It is confirmed by stamp and signature that all jobs listed in the inspection schedule of the service and repair instructions have been properly performed. The list of the inspection jobs to be performed can be found in the service manual which is available through Invacare.

Delivery Inspection	1st Annual Inspection
Stamp of authorised provider / Date / Signature	Stamp of authorised provider / Date / Signature
2nd Annual Inspection	3rd Annual Inspection

Stamp of authorised provider / Date / Signature	Stamp of authorised provider / Date / Signature
4th Annual Inspection	5th Annual Inspection
Stamp of authorised provider / Date / Signature	Stamp of authorised provider / Date / Signature

**Australia:**

Invacare Australia Pty. Ltd.
Unit 18/12 Stanton Road,
Seven Hills, NSW 2147,
Australia
Phone: 1800 460 460
Fax: 1800 814 367
orders@invacare.com.au
www.invacare.com.au

EU Export:

Invacare Poirier SAS
Route de St Roch
F-37230 Fondettes
Tel: (33) (0)2 47 62 69 80
serviceclient_export@invacare.com
www.invacare.eu.com

Canada:

Invacare Canada L.P.
84 Citation Dr #14
Concord, ON L4K 3C1
Phone: 800 668 5324
www.pro.invacare.ca

New Zealand:

Invacare New Zealand Ltd
4 Westfield Place, Mt Wellington 1060
New Zealand
Phone: 0800 468 222
Fax: 0800 807 788
sales@invacare.co.nz
www.invacare.co.nz

United Kingdom & Ireland:

Invacare Limited
Pencoed Technology Park, Pencoed
Bridgend CF35 5AQ
Tel: (44) (0) 1656 776 200
uk@invacare.com
www.invacare.co.uk



Invacare GmbH
Am Achener Hof 8
D-88316 Isny
Germany



Invacare UK Operations Limited
Unit 4, Pencoed Technology Park,
Pencoed
Bridgend CF35 5AQ
UK

1663936-A 2023-09-14



Making Life's Experiences Possible®



Yes, you can.®