



medemagroup



Serial number: _____

Delivery date: _____ Year 20_____

This vehicle was supplied by:

Date: /

Dealer:

For this product You can expect to find the following documentation:

- User manual
- Service manual
- Spare parts list
- Pre-sale information

Medema A/S

Enggårdvej 7
Snebjerg
DK - 7400 Herning

Phone: +45 70 10 17 55
Mail: info@medema.com

Contents

Contents	3
Intended occupant.....	5
Intended environment.....	5
Precautions	6
Help for the visually impaired	6
FSN (Field Safety Notice).....	6
Symbols.....	7
Warning!	7
Joystick	7
Introduction.....	8
Seat and backrest	9
Flame resistance	9
Medema A/S Warranty.....	11
Part names MC 1124 Spinalus-3.....	12
Before use	13
Adjust front scock absorbers.....	14
Introduction CJSM1.....	15
Designations - buttons.....	15
Using the Joystick R-net.....	15
Symboles.....	16
Settings menu.....	18
Trouble shooting	22
Safety check.....	23
Programming	24
Serial number.....	25
Getting in and out of MC 1124.....	25
Driving the MC 1124	26
Brakes.....	30
Fuses	31
Batteries	31
Battery disposal.....	32
Charging.....	33
General care.....	34
Service intervals	34
Insurance.....	34
Storage	35
Transporting by motor vehicle.....	35
Securing to vehicle floor with 4 point straps.....	36
DAHL docking systems	38
Mounting the docking locking plate	43
General occupant restraint Instructions	45
Public transport. (Train / bus).....	49
Transporting by plane.....	50

Towing	50
Changing the wheels.....	51
Checking the battery poles.....	55
Replacing batteries	55
Light.....	57
Lap belt.....	58
Bag holder.....	58
Footplate/footrest	59
Spinalus-3 settings.....	72
Stepless adjustment of seat depth	73
Adjustment of armrests	74
Adjusting the headrest.....	79
Swing-away fitting for Spinalus-3	79
LED errors	84
Reconditioning	85
Returning electronic devices	86
Technical data.....	87
Cassation	89
Seat angles.....	90
Own notes	91

Intended occupant

The intended occupant of the wheelchair is a person with limited or no ability of working themselves.

The wheelchair is equipped with a joystick control which makes it usable for an occupant who only has functionality in the fingers. It can be driven with only one hand either left or right.

The occupant must be able to see in order to register traffic signals and other road users when driving in traffic. The occupant can be deaf and/or speechless.

The occupant must have a cognitive ability to understand the operation of the joystick and its buttons and icons.

The maximum occupant weight is 150 kg.

Intended environment

Your power chair is designed to perform admirably on packed soil, grass, solid ground and gravel. Feel free to use your power chair safely on lawns and in park areas.

Operating temperature: -25° to +50° Celsius

Storage temperature: -40° to +65° Celsius



Do not use your power chair in fresh or salt water.

Precautions



Operating in rain, snow, salt, mist/spray conditions and on icy/slippery surfaces can have an adverse affect on the electrical system. Maintain and store your power chair in a dry and clean condition.



Prolonged exposure to hot or cold conditions may affect the temperature of upholstered and non-upholstered items on the power chair, possibly resulting in skin irritation. Exercise caution when using the power chair in extremely hot or cold conditions or when exposing your power chair to direct sunlight for prolonged periods of time.

Help for the visually impaired

If you have difficulty reading small print in the user manual, we recommend that you visit our website, where you can read this manual in PDF format. You can enlarge the PDF manual on your PC monitor to suit your needs and preferences.

If you find it difficult to understand the manual and have general questions about the product, please feel free to contact us. You can find our contact info on page two in this user manual.

You can find manuals for all our products on our web page www.medema.dk. Or contact Medema A/S, and we can send the manuals in a mail for you. Find the contact information on page two in this manual.

FSN (Field Safety Notice)

All information concerning safety can be found at www.medema.com, which is always updated with the latest safety information. In the event of important safety-related changes, we will notify our customers directly (FSN).

Symbols



Used in the manual to indicate sections describing situations where extra care is required owing to the risk of personal injury.



Used to indicate sections on electromagnetic compatibility (EMC).

Warning!



For safety reasons the vehicle must not be lent to persons who are not completely familiar with it. The vehicle is designed for one person only.



The MC 1124 has been designed for persons weighing up to 150 kg.

Joystick



The joystick control box must not be exposed to extremes of temperature or kept in a damp environment for extended periods.



The joystick control box must not be subjected to heavy knocks.



Do not switch off the control box while driving, except in an emergency, as this may damage the electronics.



For cleaning, use a damp cloth with slightly soapy water. Do NOT allow any water or moisture to enter the control box.

Introduction

Congratulations on your new MC 1124 electric mobility wheelchair.

You are now the owner of an electric mobility wheelchair developed for use indoors as well as outdoors. It is what is called a Class B vehicle according to the European standard EN 12184.

To get the best out of this vehicle - and to avoid breakdowns and accidents - we recommend that you read this User Manual carefully. If you are a new user, you should pay particular attention to the section "Driving the MC 1124".

The MC 1124, and any assistive product are designed to stay safe to use for at least 10 years, providing it has service and safety inspections every third year. The service must be carried out either by Medema A/S or an authorised workshop.



IMPORTANT! For safety reasons it is of the utmost importance that service and safety check intervals are complied with, as this minimises the risk of brake failure and short-circuits in the wiring, which could generate heat and cause a fire.

We offer a wide range of accessories for the MC 1124 that can make everyday life easier for you. You are always welcome to contact us for further information on special accessories and adaptations.

Medema Production A/S is not responsible for any damage or injuries caused by inappropriate or unsafe use of the MC 1124.

If you have any further questions about the MC 1124 or this User Manual, you are always welcome to get in touch. Our contact details are as follows:

Medema A/S
Phone: +45 70 10 20 54
Email: info@medema.com
Internet: www.medema.dk

NB: Errors and omissions excepted. We reserve the right to update this manual as required.

Seat and backrest

The cover of the seat and backrest can be washed in the washing machine. ALWAYS follow the washing instructions on the back of the seat pad / backrest.



Flame resistance

The Mini Crosser seat's flame resistance has been tested in accordance with DS/EN 1021-2:2014 Furniture - Assessment of the ignitability of upholstered furniture - Part 2: Ignition source match flame equivalent.



Warning

The seat may become very hot if exposed to direct sunlight. Similarly, the seat will become very cold if it is exposed to cold temperatures, e.g., frost.

Manufacturer
Medema A/S
Enggårdvej 7
DK-7400 Herning

Herning, 31. May 2022

EC – Declaration of conformity MC 1124

Medema-A/S declares on our sole responsibility that the product range mentioned below are manufactured in accordance with our incorporated standards and are in conformity with the following directives and standards if they are used according to our instructions:

Regulation (EU) 2017/745 of the European Parliament and of the Council of 5 April 2017 on medical devices.

EN 12184:2014 Electrically powered wheelchairs, scooters and their chargers - Requirements and test methods.

Directive 2006/42/EC of the European Parliament and of the Council of 17 May 2006 on machinery, and amending Directive 95/16/EC.

Directive 2011/65/EU of the European Parliament and of the council of 8 June 2011 on the restriction of the use of certain hazardous substances in electrical and electronic equipment.

DS/EN IEC 63000:2018 Technical documentation for the assessment of electrical and electronic products with respect to the restriction of hazardous substances.

ISO 14971:2019 Medical devices – Application of risk management to medical devices.

Type of use : Transporting walking disabled people.
Risk Class : 1 according to rule no. 1.

The product range in the **MC 1124** includes the following items:

Product name	Basic UDI-DI
MC 1124	5707299MC1124MV
MC 1124 Low Rider	5707299MC1124LRHU
MC 1124 Child	5707299MC1124CHGD

Medema-A/S



.....
Klaus Smedegaard
General Manager

Rev. 4

Medema A/S

Enggårdvej 7
Snebjerg
7400 Herning

CVR/VAT: DK 51 89 27 12
SRN: DK-MF-00000981
Phone: 70 10 17 55

info@medema.com
www.medema.com



medemagruppen

Medema A/S Warranty

1:

There is a 2-year warranty, with the exception of worn parts such as tires, hoses, fuses, light bulbs, bushings and brake pads.

2:

If you want to make a claim for a part under the warranty, it must be intact. The warranty will be void if the product has been removed or appears to have been mishandled.

3:

There is a 5-year warranty against breakage and corrosion of the undercarriage.

4:

For the warranty to cover batteries, the charger used must be sold by Medema A/S.

The fabric, type and serial number must be indicated on the warranty specification, otherwise, warranty coverage may be denied.

5:

Items returned under a warranty claim must be suitably packaged to prevent damage during transport. Items damaged during transport due to poor packaging will not be covered by the warranty.

6:

The warranty does not cover freight costs.

7:

The warranty requires inspection according to the intervals specified in the technical specifications. Service and maintenance must be carried out by Medema authorised professionals.

Part names MC 1124 Spinalus-3

The part names given below refer to the descriptions later in the instruction manual.



Before use

Before using the MC 1124, the chair must be adjusted to the user.

1. *Seat width adjustment. The seat width are usually decided before ordering a new chair. so it is only if something changes that it may be necessary to change the seat width.*
2. *Adjustment of the seat dept. Without user in the chair. See the section Stepless adjustment of seat depth in the User guide.*
3. *Adjustment of armrests. With user in the chair. Adjust height, forward/backward, in/out and angle. See the section on adjusting armrests in the User Guide.*
4. *Adjusting the headrest. With user in the chair. See the section on adjusting the headrest in the User guide.*
5. *Adjusting the footrest. If it is a manual footrest, you need tools to adjust. But if it is electric, the user can adjust the footrest with the joystick. See how in the section - Footplate/footrest.*

Important!

If the user weight for the adult user exceed 100 kg, the front shock absorbers needs to be tightened. The shock absorbers must be adjusted equally on both sides. See next page.

Adjust front scock absorbers



The front shock absorber are placed here. One on each side.



Use a plier tool to adjust the shock absorber. It is important that they are adjusted equally on both sides.

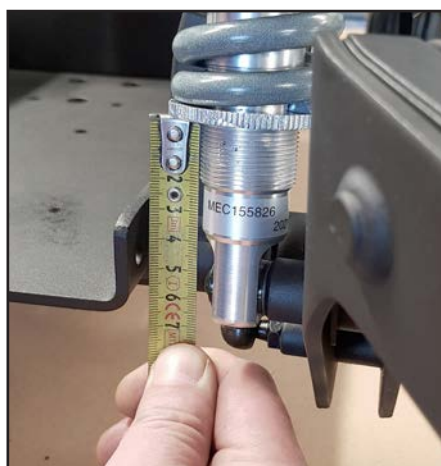

Turn the adjusting nut until there is 20 mm tread visible underneath.





Introduction CJSM1

CJSM1 is a full programmable module based controller system, that makes it possible for the user to fully control movement and speed.

Designations - buttons

CJSM1		
	1	Start/stop-button
	2	Indicator right
	3	Function button
	4	Set up / change profile
	5	Horn
	6	Joystick
	7	Speed decrease
	8	Speed increase
	9	Light
	10	Indicator left
	11	Warning LED
	12	LCD screen

Using the Joystick R-net

Speed selection with joystick R-net	
1	To start the wheelchair: Press button 1  and wait for the battery indicator to stabilise (3-5 seconds)
2	Select the maximum speed:  Keep pressing button Speed increase to maximize and Speed decrease to minimize the maximum speed.
Driving	
1	Start driving by moving the joystick  in the direction you want to travel. The speed depends on how far forward you push the joystick. To brake, return the joystick to the starting position in the centre.
2	It is important to check the battery indicator  regularly to prevent the chair stopping because of flat batteries.

Note!







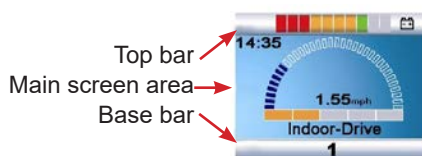

If you are driving on a sloping surface with poor grip, e.g. gravel or snow, it is important to brake gently to avoid losing control of the chair. To brake gently: move the joystick to the central position SLOWLY.

Symboles

At the top of the display you will find the status bar. Battery indicator is displayed constantly. The clock can be turned on or off as you wish. The other is lit when the corresponding function is activ.



	<p>Battery indicator Red, yellow and green (All bars) = Fully charged Red and yellow (Bar 1-7) = Ok, but charge when possible. Red (Felt 1-3) Steady light or slowly blinking = Charge now! Warning! Do not try to operate the chair, when the battery is almost empty. It can leave user stranded in an unsafe situation, as in the middle of the road.</p>
	<p>Time is shown as digitals in the top left corner.</p>
	<p>Speed indicator. Tells the instantaneous speed (km / h)</p>
<p>1</p>	<p>Active profile =1</p>
<p>Indoor-Drive</p>	<p>Profile text. Shows the name of the active profile.</p>
	<p>When the control system contains more than one method of direct control, such as secondary joystick module or a Dual attendant module, this icon will show on the active / in charge control module.</p>
	<p>If the speed of the wheelchair is being limited; for example, by a raised seat, then this orange symbol will be displayed. If the wheelchair is being inhibited from driving, then this red symbol will be flashing.</p>
	<p>When the control system is operating in a latched condition this symbol will be displayed.</p>
	<p>The system need to restart.</p>
	<p>The control system have detected an error, but it is not severe enough to cause the system to trip.</p>
	<p>The control system has intentionally reduced the power to the motors, in order to protect them against heat damage.</p>
	<p>the control system has intentionally reduced its own power, in order to protect itself against heat damage.</p>
	<p>the control system is changing between different states. An example would be entering into Programming Mode. (Only for service technicians)</p>

 <p>E-Stop</p>	<p>If the External Profile Switch is activated during drive, or actuator operation, this symbol will be displayed.</p>
	<p>When Blue tooth Mode is entered the following screen will be displayed.</p>
	<p>If you operate the Joystick before or just after you switch the control system on, the screen will flash the joystick displaced screen. You must release and centre the Joystick to resume normal operation. If you do not release the Joystick within five seconds the wheelchair will not be able to move, even if you release the Joystick and operate it again. The screen will display a diagnostic screen at this time. You can reset this condition by switching the control system off and on again.</p>
 <p>Backrest</p>	<p>Displays the sections of the chair currently selected for movement.</p>
 <p>Bluetooth</p>	<p>When Bluetooth Mode is entered the following screen will be displayed.</p>
	<p>This symbol will be displayed for a short time before the R-net enters into a sleep state.</p>
	<p>When the control system safety circuits have operated and the control system has been prevented from moving the wheelchair a diagnostics screen will be displayed. This example show a warning of low battery voltage, and a trip code in the top right corner.</p>

Settings menu

Set Time

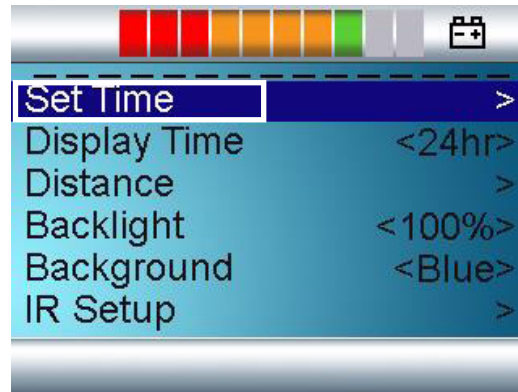

The menu is accessed by depressing the Speed Down and Speed Up buttons simultaneously (Pos 7 and 8 in the table Designations - buttons).



A right joystick deflection will enter a clock adjustment screen in which further joystick deflections are used to set the time.

Choose Exit to save and return to the main screen.

Set Display Time

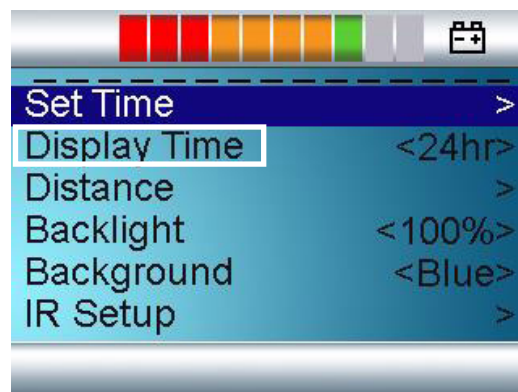

Choose the menu Display Time with the joystick. A right joystick deflection, enter the menu.

The following possibilities appears: 12hr, 24hr or OFF.
Deflect the joystick to the right /left to choose the menu you want. Choose Exit

Set Distance

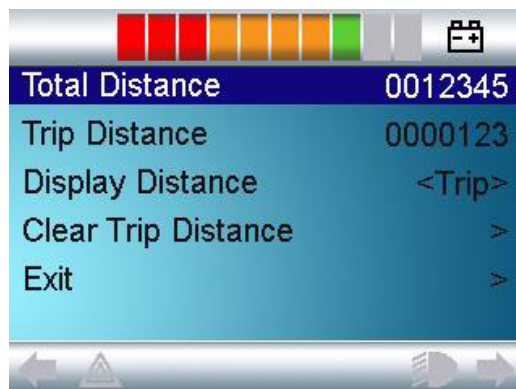
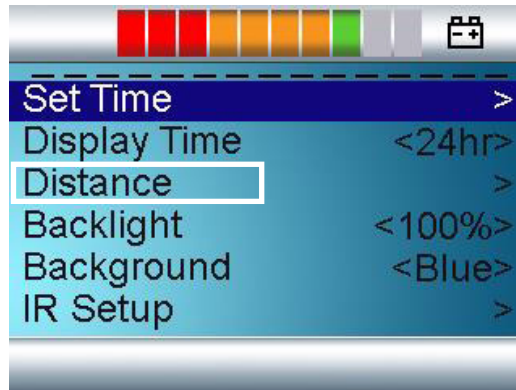

This sets the functionality of the odometer and a screen as below will appear.

Total Distance show the total distance this chair has driven with this Power module.

Trip Distance show the distance driven since last reset.

Select in this menu which value to show on the main screen.

The menu, Clear Trip Distance, resets the Trip distance to zero.

Exit - return to previous menu.

Set Backlight

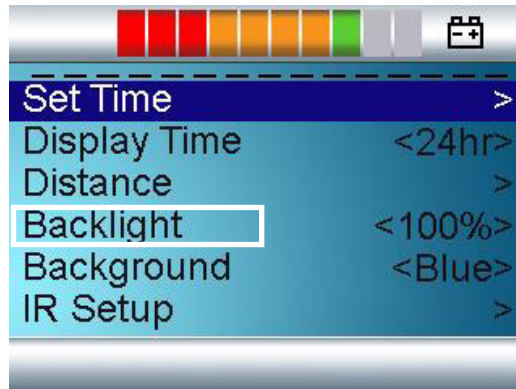

This sets the intensity of the LCD backlight. The adjustable range is 0% to 100% in steps of 10%. Adjustments are made with left and right joystick deflections.

Set Background

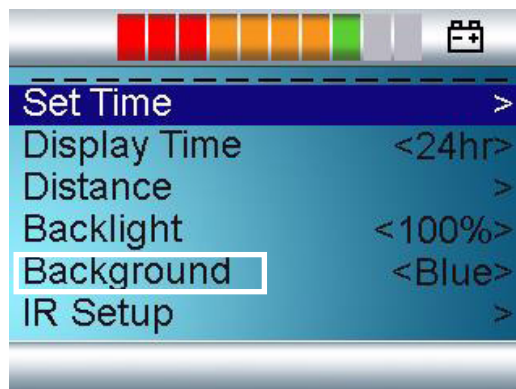

The standard setting from the factory is blue. But in bright sunlight, the white background can be better.

Options are: Blue, White, Auto.

If the choice is blue, it means that the background is blue in all profiles.

If the choice is white, it means that the background is white in all profiles.

If the choice is auto the background is controlled by the parameter Background, where the background can be set per profile a.e. Blue for Indoor use, and White for outdoor profile.

Infra red







For full details on how to learn, delete and use the IR functions available please contact Medema A/S.

Exit

Leave Settings and go back to normal use by choosing Exit.

Adjusting seat and footrest

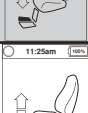
Turn on the joystick and press the Function button (Mode) Use the joystick left/right to select the function you want to adjust. Press the joystick up/down to adjust.

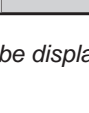
Function	Icon
Tilt	
Seatback angle	
Seat lift	
Left leg support	
Right leg support	
Footrests both	
Resting position	

Only the available settings will be displayed.

System lock

Locking the system



Press and hold the ON/OFF button down for four seconds while the system is ON. Push the joystick forward until you hear a beep. Push the joystick back until you hear a beep. Now the system is locked.

Unlock the system



Push the joystick forward until you hear a beep. Push the joystick back until you hear a beep. Let go of the joystick. The system start in normal mode.

Trouble shooting

If a system trip occurs, you can find out what has happened by counting the number of LEDs on the battery gauge that are flashing.

Below is a list of self-help actions. Try to use this list before you contact your service agent.

LED	Meaning
1 LED	The battery needs charging or there is a bad connection to the battery. Check the connections to the battery. If the connections are good, try charging the battery.
2 LED	The left hand motor has a bad connection. Check the connections to the left hand motor.
3 LED	The left hand motor has a short circuit to a battery connection. Contact your service agent.
4 LED	The right hand motor has a bad connection. Check the connections to the right hand motor.
5 LED	The right hand motor has a short circuit to a battery connection. Contact your service agent.
6 LED	The wheelchair is being prevented from driving by an external signal. The exact cause will depend on the type of wheelchair you have.
7 LED	A joystick fault is indicated. Make sure that the joystick is in the centre position before switching on the control system.
8 LED	A possible control system fault is indicated. Make sure that all connections are secure.
9 LED	The parking brakes have a bad connection. Check the parking brake and motor connections. Make sure the control system connections are secure.
10 LED	An excessive voltage has been applied to the control system. This is usually caused by a poor battery connection. Check the battery connections.
7 LED+ S	A communication fault is indicated. Make sure that the joystick cable is securely connected and not damaged.

Safety check

Daily safety check:

The electronic system has an integrated safety check which runs up to 100 times per minute. To supplement this check, you should carry out the following regular checks.

- Switch off the electronic system (no lights in the display)
- Check if the joystick is bent
- Check if the joystick is damaged in any other way
- Check that it returns to the central position when you release it

If the check reveals any problems, contact a competent service engineer before using the wheelchair again.

Weekly safety check:

Parking brake: This test must be carried out on a flat surface with at least one metre of free space around the wheelchair.

- Start the wheelchair and slowly move the joystick forward. There is a clicking sound. (The wheelchair may start to move in this setting).
- Immediately release the joystick and listen for the clicking sound, which should occur within one second.

Repeat in all directions.

- Check that the rubber bellows around the joystick is intact. This is important, as the bellows prevent moisture getting into the electronic system.
- Check that the control box is properly secured.

If the check reveals any problems, contact a competent service engineer before using the wheelchair again.

Monthly check

Check the tyre pressure at least once a month. It should be 2.4 bar.

Service

The MC 1124 is designed to stay safe to use for at least 10 years, providing it has service and safety inspections every third year. The service must be carried out either by Medema A/S or an authorised workshop.



IMPORTANT!

For safety reasons it is of the utmost importance that service and safety check intervals are complied with, as this minimises the risk of brake failure and short-circuits in the wiring, which could generate heat and cause a fire.

Programming



The Dynamic electronic system is programmable so that the driving characteristics can be optimized for individual users. Programming must only be carried out by people trained in the control systems. Changing parameters incorrectly can produce driving characteristics that are dangerous for the user.

Serial number

All wheelchairs have a serial number plate showing the year of production, month and serial number. The same serial number can also be found on page two of the User Manual.

Please quote this number when making inquiries about servicing, spare parts, etc.

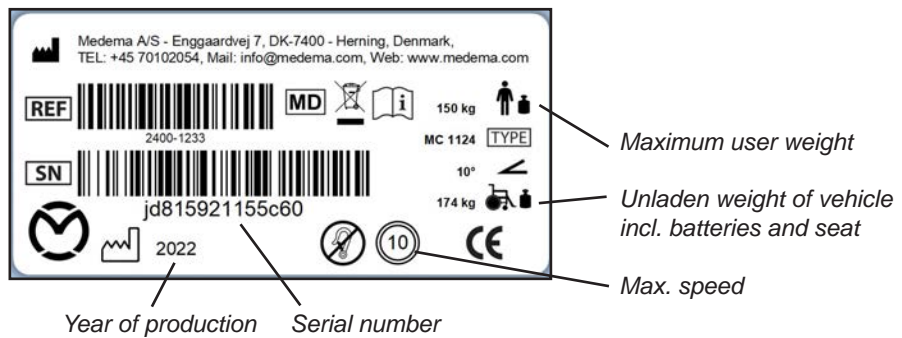

Position of serial number plate on vehicle.

Getting in and out of MC 1124

MC 1124 is a modern device, specially developed to help you achieve maximum mobility.



If you are able to move yourself to and from the electric wheelchair, follow the procedure below.

Depending on your handicap, a helper may be needed to lift you in and out of the chair.

Before entering or leaving the chair, make sure that:

- That the wheelchair is switched off.
- That the wheelchair is not disengaged.
- That the wheelchair and the seat you are moving to are both stable.
- Lift up the armrests.
- Avoid placing your full body weight on the footrests.
This may tip the wheelchair forwards. Swing the footrest to the side to leave space to stand on the floor.

Driving the MC 1124

If you are using the MC 1124 for the first time, you should try out all the day-to-day situations you are likely to encounter:

- inclines/declines,
- driving on rough terrain
- driving on sloping terrain.

You should practice these manoeuvres with your therapist or other carer.



Warning!

The seat should NEVER be hoisted while driving on uneven surfaces, slopes or up and down kerbs. The higher the seat is raised, the more unstable the chair becomes.

Arms and legs

While driving, you must place your arms on the armrests and your feet on the footrests.

Cables and leads

Always make sure that cables and leads from components like the joystick are fixed using ties.

Changes of level

Never attempt to climb onto raised objects or kerbs higher than 7 cm. Always approach changes of level head on, with the front and back wheels moving in a straight line. (See below.) This reduces the possibility of tipping.

Note!



If your MC 1124 vehicle is fitted with a docking system from Dahl Engineering, note that the clearance is reduced to 5.5 cm.



Fig. 1



Fig. 2



Fig. 3



Fig. 4

Driving on hills

When driving on hills, you should try to keep the wheelchair moving all the time. If you have to stop, start up again slowly.

When driving downhill, you must drive at the slowest speed.

If the MC 1124 starts moving faster than you want, stop it by completely releasing the joystick. Carefully push the joystick forwards again and carry on with care until you reach the bottom of the hill.



Be aware that the stopping distance can be significantly longer, down hill, than on level ground.



Avoid many starts / stops when driving on steep hills. It can overheat the MC 1124.

10 tips for driving the MC 1124:

- Reduce the speed when turning corners and going downhill.
- Reduce the speed when driving on inclines. Maximum incline: $6^\circ = 10\%$
- Reduce the speed when driving on a sideways incline. Maximum sideways incline: 6°
- Avoid parking on snow and ice.
- Always park on a level (flat) surface.
- Avoid driving on rough ground.
- Avoid driving on icy surfaces, or smooth surfaces (for example snow or freshly mown grass)
- Never attempt to climb kerbs higher than 7 cm. If the wheelchair has a docking system, the clearance is reduced to 5,5 cm.
- Avoiding driving over kerbs diagonally. There is a risk of tipping over.
- Not to be used for towing other vehicles, etc.

Note!



Talk to your doctor if you are taking medicine that may affect your ability to drive motorised vehicles.

Do not drive the MC 1124 when intoxicated. This applies to both medicine and alcohol.

Warning!



If the vehicle behaves abnormally in any way - makes noises, smells burnt, etc. - stop the vehicle immediately and seek technical assistance. By continuing to drive, there may be danger of fire or that vital parts are destroyed.

Driving on public roads:

When driving on public roads, footpaths, pedestrian streets, car parks, shopping centres, etc. you must make sure you adjust your speed and distance for other users. At 7 km/h you must follow the traffic rules applicable to cyclists. This also means that your lights must be switched on during lighting-up time. (Optional extra)

On footpaths, the maximum speed is 6 km/h. In this situation you are regarded as a pedestrian.



Note!

You should assume that other road users cannot see you while you are sitting in the MC 1124. So take great care and wait for the road to clear before crossing.



Driving on stairs/escalators:

The wheelchair is not designed for use on stairs or escalators and any attempt to do so may cause serious injury to yourself and others.

Electromagnetic compatibility (EMC)



The MC 1124 satisfies the requirements for the use of wheelchairs in an environment with electromagnetic noise.



Warning!

In rare cases electromagnetic noise can affect the MC 1124. Sources of such noise include radio and television stations and amateur radio transmitters.

If such equipment is being used close by, you are recommended to switch off the MC 1124.

If the MC 1124 starts making unintended movements, or if the brakes are released, turn the MC 1124 off as soon as it is safe to do so.



Warning!

In rare cases an MC 1124 might disturb the operation of devices in its environment that emit electromagnetic fields, such as alarm systems of shops, automatic doors etc.

The control systems have been tested and meet the requirements of DS/ISO 7176-14 and DS/EN 12184.

Brakes

The MC 1124 is equipped with two sets of brakes: The motor brake and the parking brake.

Motor braking:

When you drive downhill, the control unit of the MC 1124 applies the motor brake.

Parking brake:

When the vehicle is stationary and the joystick is not moved, a magnetic brake is automatically applied to each drive unit. For driving, the magnetic brake is released first, after which the MC 1124 can be driven as described above.

Note!



You must NEVER brake the MC 1124 by switching off with the I/O button while moving, as this applies the magnetic brake with considerable force, with a resulting risk of tipping.

Disengagement:

The MC 1124 is equipped with two disengagement levers: One on each side of the vehicle.



ALWAYS disengage on both sides.

Warning!



When the wheelchair is disengaged, the braking system is deactivated. Before an occupant is left unattended or attempts to operate the wheelchair, make sure that the disengagement handles are placed in (normal position for driving), which means it's connected (the chair can not be pushed).

You must NEVER disengage on sloping terrain. This can lead to serious damage or personal injury.



Normal position for driving - pushed up



Position for disengagement - pushed down

Fuses

On the left of the MC 1124 behind the seat, there is a automatic fuse protecting the battery circuit.

The fuse is white. If it pops out, you can push it back in again after a few minutes. If it immediately pops out again, contact your authorised dealer.

The fuse can also be pulled to disconnect the power. Be aware, that you must pull it quite hard.

There are no external fuses that need to be replaced.

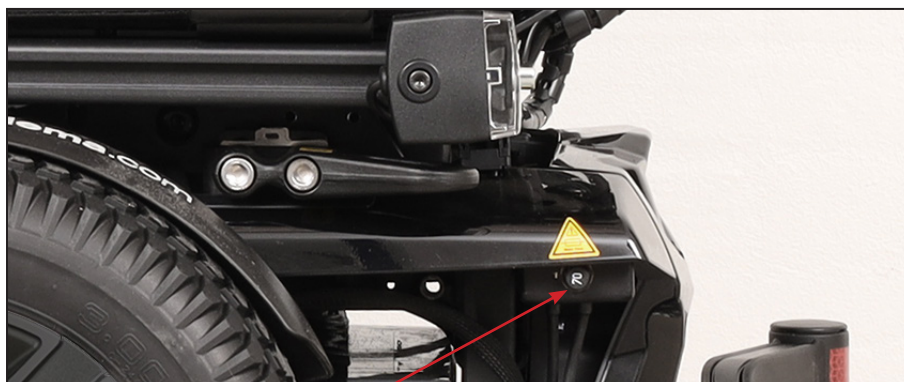

The automatic fuse is placed here.

Batteries

The battery indicator shows how much power is available to the wheelchair.

- Red, amber and green indicate that the batteries are fully charged.
- Red and amber indicate that the batteries will soon need recharging.
- Red indicates that the batteries need to be recharged as soon as possible, otherwise the wheelchair will cut out.

The MC 1124's batteries should be charged while not in use. This extends the service life of the batteries.

The MC 1124 is supplied with sealed, maintenance-free batteries that do not normally generate gas and do not need to be topped up with water.



Note!

Unsealed batteries must NEVER be installed in the MC 1124.

If charging is to take place outdoors, an enclosed charger without a fan should be chosen.

Only use chargers designed for charging dry maintenance-free GEL or AGM batteries.

Max. charging current 12 A.

The charging cable must NOT be extended.



Batteri service only by a service technician.

New batteries can be purchased from Medema A/S.



Note

If the battery is 100% discharged (deep discharge), it is not possible for the charger to start charging the battery.



There is no warranty on batteries that have been damaged as a result of deep discharging.

Battery disposal

Used batteries must be disposed of through your supplier or at a recycling centre.

Take care in handling any leaky batteries, as they contain corrosive acid bound into the gel mass.

INFO: New batteries can be purchased from Medema A/S.

Charging

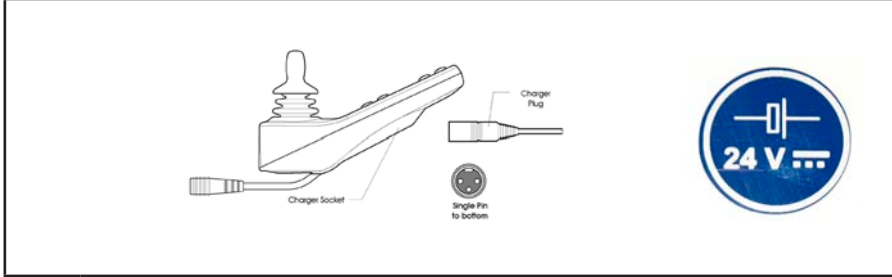

Charging	
1	Plug the cable into the control box on the wheelchair.
2	Plug the charger into the outlet or switch it on.
3	Use the indicator lights on the charger to check that charging has started.
4	When charging has finished, switch off or unplug the charger, and then remove the charger cable from the control box.

The actual battery indicator on the vehicle will show “full” after charging for a short time. However, the batteries are not fully charged until the indicator on the CHARGER turns green.

Note!

New batteries reach full capacity after approx. 20 discharge/charge cycles.

Please note that the capacity of the batteries will reduce over time and at low temperatures. Battery capacity at -10°C is half that at +20°C.

If the MC 1124 is not going to be used for an extended period, charging once a month will suffice.



Note!

The charger must NOT be placed on the seat during charging.

Charging while the vehicle is switched on

- The battery indicator will flash during charging.
- After charging, the battery indicator will flash for about 1 minute after the charging cable is unplugged.

General care

If you get food or drink, etc. on the control unit, you should wipe it with a damp cloth.

You must only use a damp cloth to clean the MC 1124.



Note!

Using a high-pressure cleaner or hose may damage the wheelchair's electronic system.

Service intervals

The MC 1124 is designed to require a minimum of maintenance.

However, you are recommended to take it to your dealer for inspection every third year.



IMPORTANT! For safety reasons it is of the utmost importance that the servicing and safety check intervals are complied with, as this minimises the risk of brake failure and short-circuits in the wiring, which could generate heat and cause a fire.

(For further information see the Service Manual.)

Insurance

An MC 1124 with a maximum speed of 10 km/h is in the eyes of the law a bicycle, and no separate insurance is required.

Most contents/home insurance policies include third-party liability insurance for cyclists and so also cover MC 1124 users.

We recommend that you talk to your insurance company about this when the vehicle is delivered. If necessary, comprehensive insurance will have to be taken out separately.

Storage

The wheelchair should be stored and charged under cover, preferably at temperatures above 0°C.

Storage temperature: -40° to +65° Celsius.

Note!



The charger must be kept dry, but should not be covered when in use.

For long-term storage we recommend to disconnect the power by pulling the automatic fuse, and cover the MC 1124 to protect it from dust, rain and sunlight.

When the chair is to be used again, reconnect the automatic fuse by pushing it in, recharge the batteries completely. Check all functions.

Transporting by motor vehicle

The MC 1124 must ALWAYS be secured while being transported.

To lift the wheelchair, use the pivot wheels at the front and back. Avoid lifting by the seat or side panels.

Secure it in the vehicle with belts attached to the two eyes at the front and two at the back. All the eyes are marked in yellow.

Important



The vehicle is approved for use as a seat during transport, with a user weight of up to 136 kg.



Eyes for restraints

Important!



If your MC 1124/vehicle is fitted with a docking system from Dahl Engineering, read the instructions supplied with the docking system.

Securing to vehicle floor with 4 point straps

For wheelchairs heavier than 85 kg, it is recommended to use an ISO 10542-1 compliant WTORS (Heavy Duty System), which is rated for the total weight of the wheelchair including any additional equipment. If using a Heavy Duty system, use 4 straps to secure the wheelchair, 2 straps at the front and 2 straps at the back.

The MC 1124 is tested with the Dahl Engineering 4-point heavy duty system, which is approved for the chair's total weight including all accessories.

Never use equipment that is not marked with ISO 10542

The belts must always be attached to approved fittings in the vehicle and the four eyes welded to the MC 1124.

The belts **MUST** be attached within the angles shown in the picture for optimum safety.

MC 1124 meets the requirements in relation to DS/ISO 7176-19-2022 for a user weight of up to 136 kg.

When load straps are fitted, the angles should fall within the preferred angles shown below.

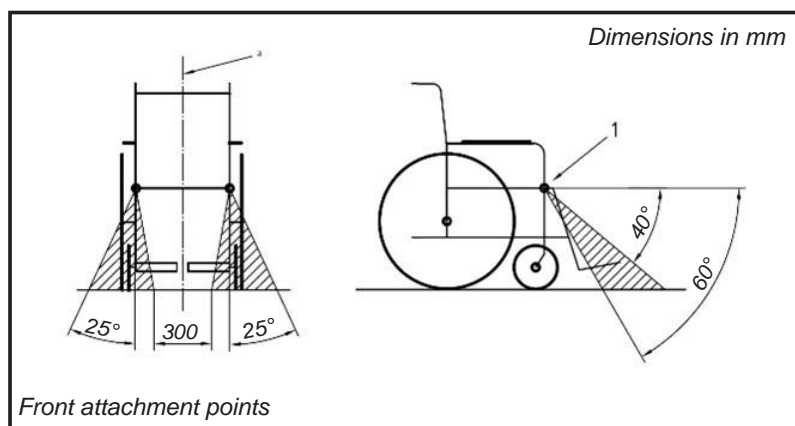

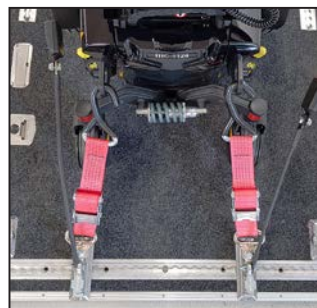
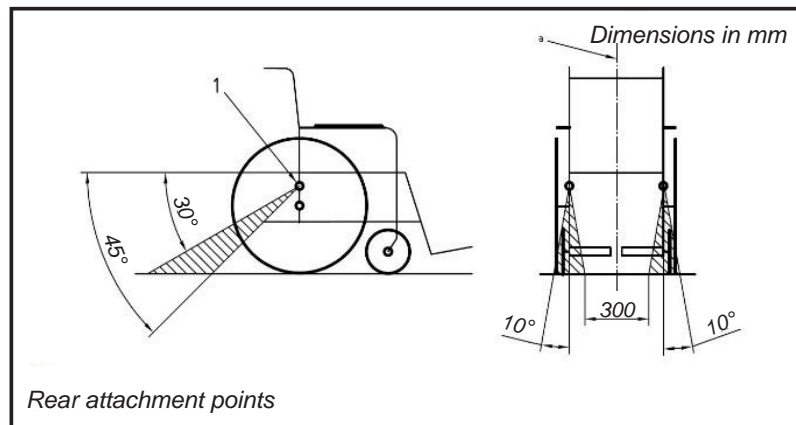

Always follow the manufacturer's instructions/documentation for fitting and using the selected 4 point wheelchair securement system.

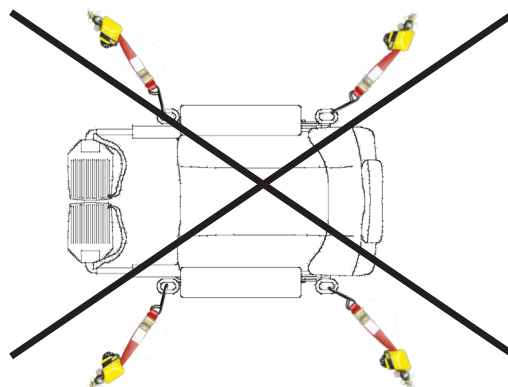

DAHL docking systems

Dahl Engineering offer two docking stations. The Dahl Docking Mk II. and the new power height adjustable Dahl VarioDock™. The lock plate and wheelchair adaptation kits and are identical for both docking stations and both are suitable for securing wheelchair model MC 1124.

The testing proved that the docking station is strong enough to cope with a load equivalent to the wheelchair weight of over 200 kg + one passenger, if the safety belt is fitted to the base of the vehicle in the traditional way.

Please also refer to Dahl Engineering's instructions for installation, use and maintenance of the system used.



Dahl docking station MK II kit #501750



Dahl docking #501750



Dahl VarioDock kit #503600

Artikel number	Description
501750	Dahl Docking Station MK.II
503600	Dahl VarioDock

Mounted in a vehicle



Docking station mounted both on the passenger and the driver side.



Wheelchair used as a driver's seat.



Wheelchair used as a passengers seat.

DAHL Engineering Løvevej 3,
DK - 7700 Thisted,
DENMARK
Tel.: +45 96 18 00 77
web page: wtors.com

Description of how the Dahl Docking system Mk II. functions

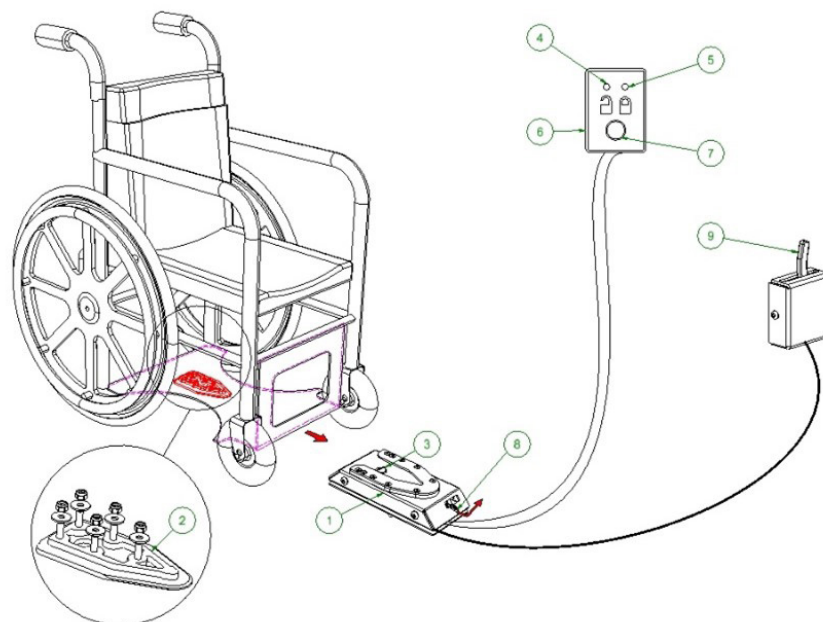

1. Dahl Docking station
2. Lock plate and spacer
3. Lock pin
4. Red LED
5. Green LED
6. Control panel
7. Release button
8. Manual emergency release lever
9. manual operating lever

Securing the wheelchair in the docking station

1. Maneuver the wheelchair slowly and in a uniform direction over the docking station. The lock plate under the wheelchair helps to guide the wheelchair into place in the docking station. When the lock plate is fully engaged in the docking station, a spring-action locking pin automatically secures the lock plate.
2. The docking station is equipped with a control switch that indicates whether the lock plate is correctly secured in the docking station. As soon as the lock plate comes into contact with the locking pin, a warning tone will sound (a high-pitched howl), and the red diode/lamp (LED) in the control panel will light up until the lock plate is either fully engaged or else the wheelchair is removed from the docking station.
3. As an indication that the wheelchair is properly secured, the warning tone will cease, the red lamp (LED) in the control panel will go out and the green lamp (LED) will light up.
4. Do not forget to buckle up for driving.

**Warning!****Do not move the vehicle:**

- Whilst the wheelchair is being maneuvered into position in the docking station
- If the wheelchair and user are not correctly secured.
- If the warning tone sounds and/or the red warning lamp (LED) in the control panel flashes or is lit!

Always check if the lock plate is properly engaged in the docking station by trying to reverse the wheel chair out of the docking station before moving the vehicle. (It must not be possible to reverse out of the docking station without pressing the red release button in the control panel).

Release from the docking station

1. *When the vehicle has been brought to a halt, remove the safety belt.*
2. *To unlock commence by driving the wheelchair forward to release pressure on the lock pin.*
3. *Press the red release button in the control panel. The locking pin will be triggered/ released for approx. 5 seconds, after which the locking pin is automatically locked/activated again.*
4. *Move the wheelchair away from the docking station within this 5-second period. Do not attempt to reverse out of the docking station until the red LED on the control module, which indicates the unlock position, has been illuminated.*

**Warning!**

Attempting to reverse the wheelchair before the red LED has been illuminated will result in blocking the docking stations locking mechanism, which makes it impossible to reverse. If this happens repeat above unlocking procedure.

Manual release in case of electric failure

A manual emergency release is located at the front edge of the docking station.

1. *Move wheelchair forward to remove the pressure on the lock pin and push the red release arm to one side and hold it there while the wheelchair moves away.*
2. *A cable-activated manual operating lever can also be fitted (accessory). The red release arm is also pushed to one side and should be held there whilst the wheelchair moves away.*

If the described manual release procedures fails, an emergency release tool made from red plastic comes with each docking station.



1. *Move wheelchair forward to remove the pressure on the lock pin*
2. *Place the emergency release tool in the gap between the locking plate and the docking station.*
3. *Push the release tool and wheelchair forward until the locking pin has been forced down - after which the wheelchair can reverse out of the docking station.*

Dahl Engineering offers two docking systems, the Mk II, and a new power height adjustable called Dahl VarioDock. Please also refer to Dahl Engineering instructions for installation, use and maintenance for the system used.

Installation of the Dahl Docking systems in the vehicle

Only professional companies in the business of converting or building wheelchair accessible vehicles can order the docking system from Dahl Engineering.

A qualified and experienced technician must carry out the installation. Dahl Engineering can provide vehicle specific installation instructions for a large range of vehicles, which must be respected by the fitter.

Please contact Dahl Engineering for further information about approved vehicles and fitting positions.

Dahl Engineering contact details are available at: www.dahlen-engineering.dk

Mounting the docking locking plate

The MC 1124 is prepared mounting of the docking locking plate (Dahl adaptation kit art.No 502378), by predrilled holes in the chassis.

To mount the docking locking plate:
Turn of the chair.

- Dismantle the legrests if mounted.
- Remove the seat
- Remove the hoist and tilt module.
- Remove the batteries.

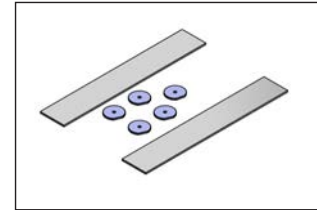

Adaptation kit.
Art.No 502378

Now the bottom of the chassis can be accessed, and the locking plate can be mounted.

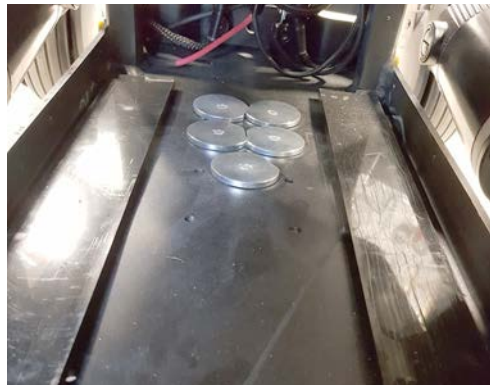

Docking locking plate and adaptation kit art.no. 502378 to MC 1124

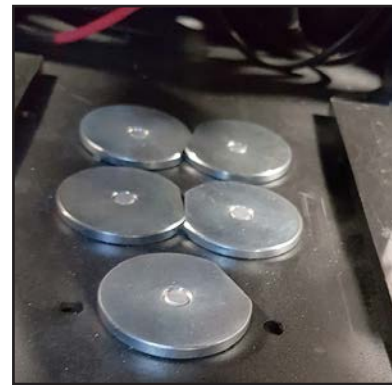

The nuts are placed in the drilled holes.



The included screws must be fixed with loctite 222 before they are placed in the locking plate, and screwed up into the nuts. Tighten 16-18 Nm.



Docking locking plate fitted.

Important! Use only original screws from Dahl Docking.



Place the two plates on each side of the nuts. Fix them with double sided tape or a little glue.

The screws may be too long and must then be shortened.

If they get too long, they can damage the batteries.

Important! Do not use screws other than those supplied by Dahl Engineering (Art.nr.502800, which is quality 14.9, torx key size 27). Standard countersunk M8 screws will not be strong enough in a crash.

The plates in the bottom makes it possible to slide the batterybox over the nuts.

Mount the batteries, hoist and tilt module, the seat and legrests again. Check that all functions are working ok.



The docking station is mounted in the car bottom. It must be carried out by an authorized workshop.

Move the chair over the docking station, and it will grab the locking plate. A click sound mean it is in place and secured.

To release the chair, use the electric release button that is installed in the car in the operating area. If the car is turned off, or if it just needs power, there will be a manual release lever as well.

General occupant restraint Instructions



DANGER!

- Use a 3-point occupant restraint system to secure the occupant.
- Both pelvic and upper torso restraint belts must be used to restrain the occupant to reduce the possibility of head and chest impacts with the vehicle components.
- Any wheelchair-anchored occupant restraint, i.e. 3-point belt, harness or posture supports (hip straps, lap belts) shall not be used or relied upon for occupant restraint in a moving vehicle, regardless of whether it is marked ISO 7176-19, ISO 10542-1, SAE J2249 or others. Use a vehicle anchored and certified passenger safety system instead.
- Use a suitable positioned headrest when being transported in a wheelchair.
- Wheelchair anchored postural supports (lap straps, lap belts) should not be used or relied on for occupant restraint in a moving vehicle.
- Occupant restraints should make full contact with the shoulder, chest and pelvis and pelvic belts should be positioned low on the pelvis near the thigh-abdominal junction (meeting the requirements specified in ISO 7176-19:2008).
- The upper torso restraint belt must fit over the midpoint of shoulder and across the chest as illustrated
- Restraint belts must be adjusted as tightly as possible consistent with user comfort.
- Restraint belt webbing must not be twisted when in use.
- Care should be taken when applying the occupant restraint to position the seatbelt buckle so that the release button will not be contacted by wheelchair components while driving or during a crash.
- Belt restraints must not be held away from the body by wheelchair components such as armrests or wheels.



Belt restraints must not be held away from the body by wheelchair components such as armrests or wheels.

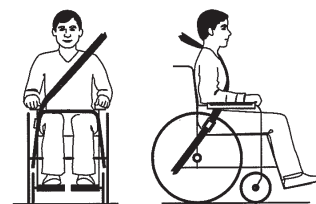

Occupant restraints should make full contact with the shoulder, chest and pelvis and pelvic belts should be positioned low on the pelvis near the thigh-abdominal junction

Positioning the occupant restraint when using it with a 4 point strap tie-down system.

Danger!



- The pelvic restraint belt must be worn low across the front of the pelvis so that the angle of the pelvic belt is within the optional or preferred zone of 30° to 75° to the horizontal. A steeper (greater) angle within the preferred zone, 45° to 75° is desirable i.e. closer to, but never exceeding 75° degrees

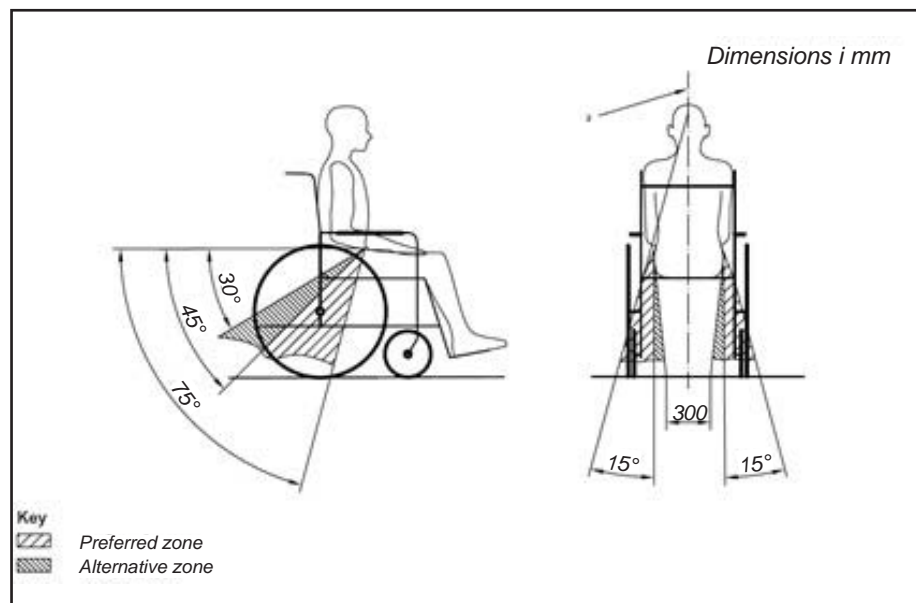

Preferred and optional angles for location of the lap belt

Positioning the occupant restraint when using it with the Dahl Docking systems only

Danger!



- When using wheelchair with Dahl Docking systems, the floor anchorage points for the occupant restraint system should be located 10-60 mm outside wheels, on each side. The pelvic belt must be worn low across the front of the pelvis so that the angle of the pelvic belt is within the optional or preferred zone of 30° to 75° as shown. A steeper (greater) angle within the preferred zone, 45° to 75° is desirable i.e. closer to, but never exceeding 75° degrees

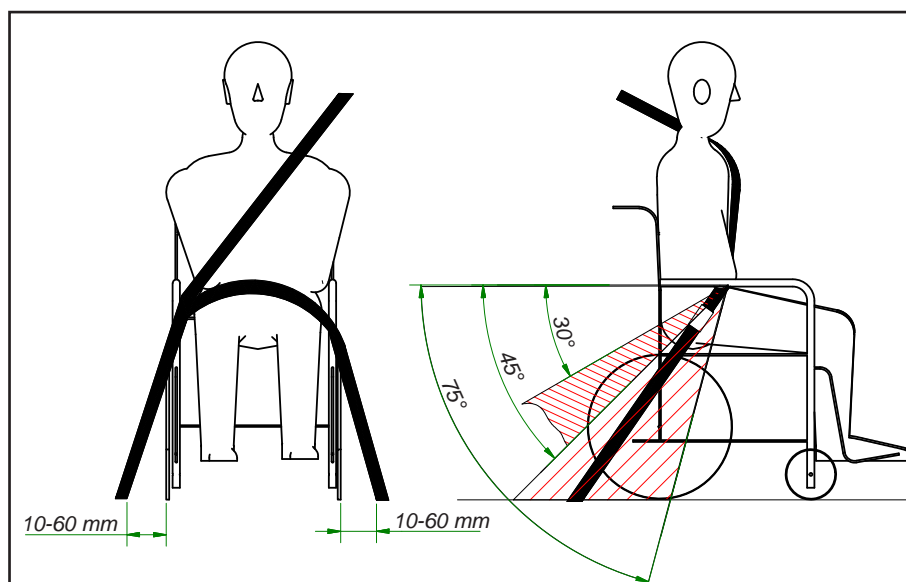

Preferred and optional angles for the pelvic belt when using Dahl Docking Systems.

The wheelchair has been dynamically tested in a forward-facing orientation with the ATD restrained by both pelvic and shoulder belts (e.g. shoulder belt as part of a three-point belt restraint).

Both pelvic- and shoulder-belt restraints should be used to reduce the possibility of head and chest impacts with vehicle components.

When possible, other auxiliary wheelchair equipment should be either secured to the wheelchair or removed from the wheelchair and secured in the vehicle during travel, so that it does not break free and cause injury to vehicle occupants in the event of a collision.

Alterations or substitutions should not be made to the wheelchair securement points or to structural end frame parts or components without consulting the wheelchair manufacturer.

Spill-proof sealed batteries, such as “gelled electrolyte” should be installed on powered wheelchairs when used in a motor vehicle.

Care should be taken when applying the occupant restraint to position the seat belt buckle so that the release button will not be contracted by wheelchair components during a crash. Belt restraints must not be held away from the body by wheelchair components such as armrests or wheels.



Incorrect use of belts

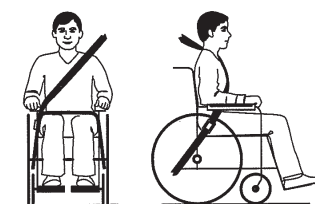

Correct use of belts

Public transport. (Train / bus)

The wheelchair is within the requirements of external dimensions of the EU directives on public transport such as trains and buses.

Nevertheless, we recommend that free fasteners be used to fasten the chair as shown below - Fastening with seat belts to the floor.

Wheelchair users should transfer to the vehicle seat and use the vehicle-manufacturer-installed restraints systems whenever it is feasible, and the unoccupied wheelchair should be stored in a cargo area or secured in the vehicle during travel.

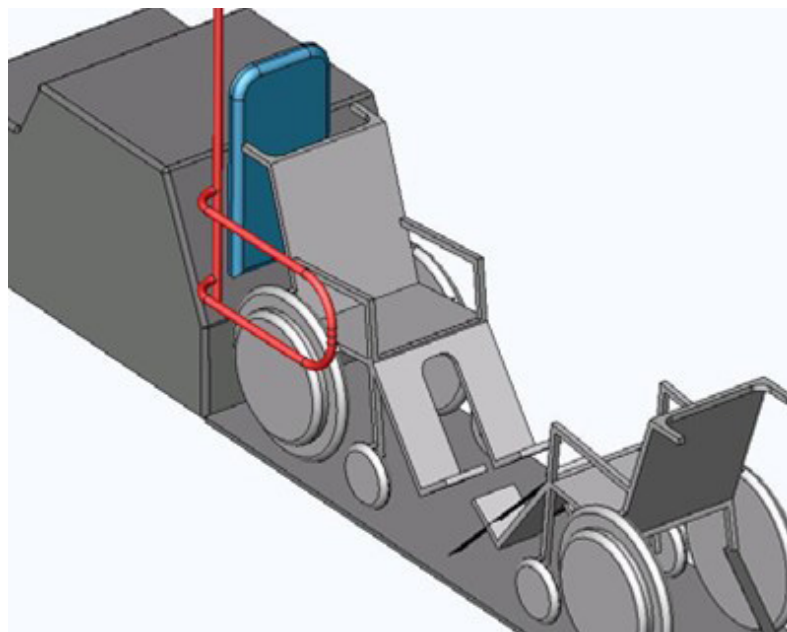

The wheelchair complies with the requirements of DS/ISO 7176-19:2008 and, as such, has been designed and tested for use only as a forward-facing seat in a motor vehicle.



Note!

Compliance with this standard does not preclude using the wheelchair facing rearward in large accessible vehicles equipped with rear-facing wheelchair passenger stations.

Transporting by plane

To transport the MC 1124 by plane, the airlines require:

- the batteries to be aircraft approved
- the air to be let out of the tyres
- the battery leads to be disconnected (not always, but frequently).

A main switch can be fitted (optional extra).

A battery declaration for air travel can be requisitioned from:

<https://minicrosser.com/tjenester/service-reparation/flycertifikat/>

Towing

If you should be unfortunate enough to break down, the MC 1124 can be towed or pushed. The MC 1124 must always be turned off and disengaged for towing. See the section on Brakes.

To tow the MC 1124, secure a rope to the tow fitting on the front - marked in yellow. Do not tow faster than 5 km/h. The wheelchair will generate electricity when it is towed, with the motors acting as dynamos. If it is towed at more than 5 km/h, there is a risk of the motors generating enough electricity to damage the wheelchair and, in the worst case, cause a fire.

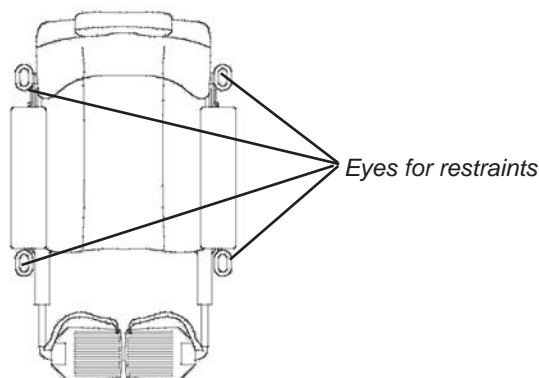

Changing the wheels

If you get a puncture in one of the pneumatic tyres or if a tyre is so badly worn that it needs to be replaced, follow the instructions below.

Tyres and inner tubes can be purchased from the authorised dealer who supplied the MC 1124.

The MC 1124 must be TURNED OFF before you start.



Jack up the MC 1124 onto a block of wood so that the wheels are clear of the floor/surface.



Central wheel

- Undo the 5 screws.
- Take off the wheel.



REMEMBER!
to let all the air out before taking the wheel apart to repair a puncture.

Use a screwdriver or similar to open the valve to let out air.



There is a risk of explosion of the wheel, if the two rims are being taken apart with air in the tire.

Undo the rim with the 5 screws.



Replace or repair the hose.
Make sure there is no dirt or foreign objects in the tire before the the hose is in place.



Pump in some air, but don't fill it completely yet.

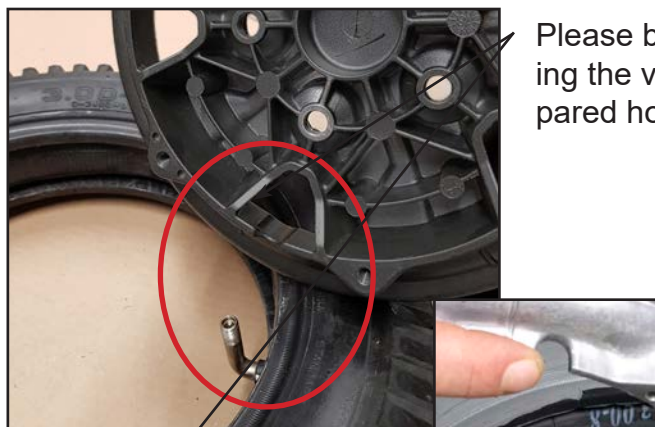

Please be aware to placing the valve in the prepared holes.

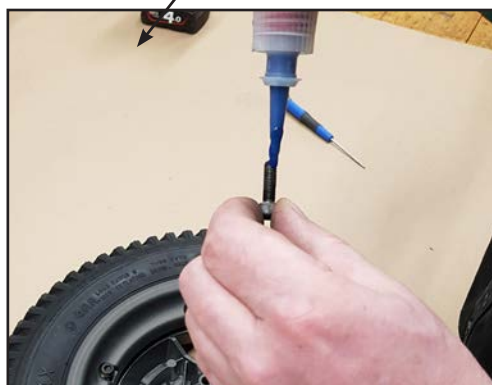

Important!
When mounting the rim, all screws must have a drop of Loctite 2400.



Mount the rim without tightening the screws.



Check that the hose doesn't get between the rim parts. Keep the rim in place while tightening the screws.

Tighten to 15 Nm



Pump the wheel to the right pressure. (see technical data)



Mount the wheel back on MC 1124 again.

Tighten to 37,6 Nm

Replacement of the Pivot wheel



Pivot wheel

Undo the central nut.

Remove the bolt that goes through the axle.



The wheel is now removable.



Mount a new wheel in reverse order.

Checking the battery poles



Battery poles

Batteries have an approximately lifetime of two years.

Check that the cable shoes are properly mounted on the poles.

If necessary, tighten the screws.

Replacing batteries

Swing split legrests to the side, and if central footplate, adjust it in the highest possible position. Raise the seat to highest position and turn the chair off.



Pull the handle down and flip the cover out.



Release the plug by pulling the red handle.



Pull the battery strap to slide out the battery box.



Batteries are heavy, so be careful when you turn the box, and "drop" the batteries.

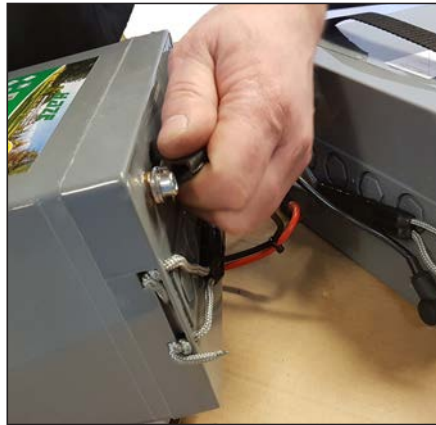

Dismantle the poles on the old batteries, and mount them on the new ones.



Place the batteries with the poles against each other.



Place the battery box on top, and turn it around.



Make sure that the plug is nearest the entrance. Slide in the battery box.



Connect the plug. Watch it from the top, and adjust /push the red handle.

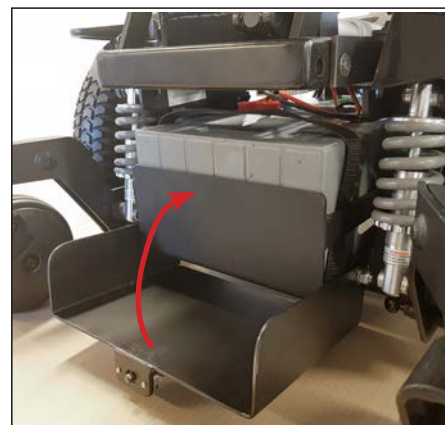

Close the cover again. Turn the chair on. Check that all functions are working ok.

Light

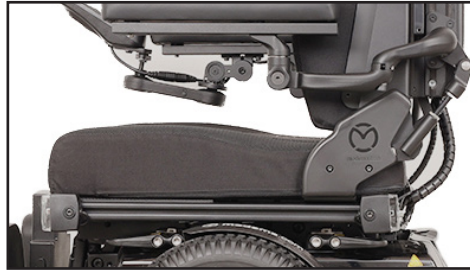

Light - direction

The direction of the light can be adjusted by:

- loosen the screw
- turn the lamp in the desired direction.
- tighten the screw again.

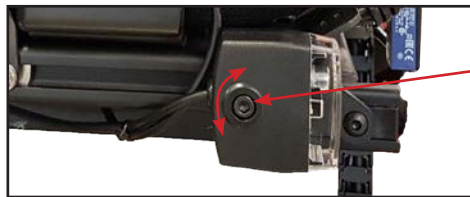

*Adjusting screw
Tool: Allen 5*



Light - located in the C-rail

The light can be moved forward/backward by:

- remove the screw/light
- disconnecting the cable if necessary.
- push the bracket in the C-rail to the position you want.
- Mount the light again.

*Adjusting screw
Tool: Allen 5*



Example - taillight

The chair is equipped with two lights in each side. Headlight and tail light.

The tail light has yellow turn signal and red tail light.

The headlight has yellow turn signal and white headlight.

Lap belt



Lap belt

If there is a need for it you can, as an accessory, mount a lap belt or harness belt on MC 1124.

The belt is designed to stay safe to use for at least 10 years.

Bag holder



On the back on the wheel chair, a bag holder can be mounted to carry a bag, shopping bag or similar.

Bag holder is an accessory. Please contact your dealer or Medema A/S. Find the contact information on page two in this manual.

Footplate/footrest

All the footrests are designed to stay safe to use for at least 10 years.

Electrical central footplate



The footplate can be adjusted forw./backw.

Adjust by loosen the two screws on the inside of the C-rail on both sides.

REMEMBER to tighten again on both sides.

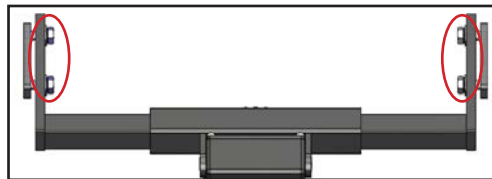

To dismantle:

- Disconnect the cables.
- Loosen the two screws in both sides, and slide the footrest of the rails.



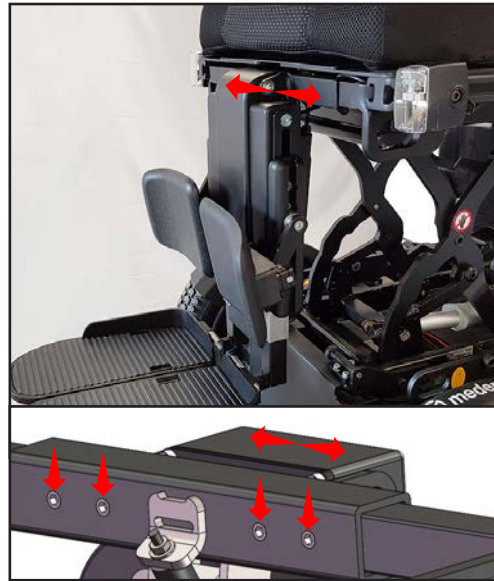

Adjust the footplate side-ways:

First the footrest must be moved forward. See how to under the point "To dismantle".

Then loosen four screws on the back of the top beam.

Adjust and tighten again. Push the footrest into place and tighten the screws.



Calf pads - Angle

You set how tight the leg pad should be to tilt, by loosening or tightening this pin bolt.



Calf pads - up/down

Loosen the screw pointed out in the picture beside. Adjust and tighten again.

Travel: 210 mm from top position to lowest position.

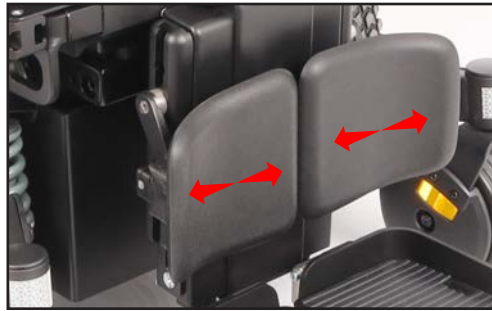

Calf pads in/out



Loosen the screw indicated in the adjacent image. Adjust and tighten again.

Travel: 40 mm from inner position to outer position.

Adjustment of footplates



Manual adjustment of the height of the footplates.

Loosen the screw at the back, adjust and tighten again.



Angle of footplates

Adjust by unscrewing / adjusting this pin screw to the desired setting.

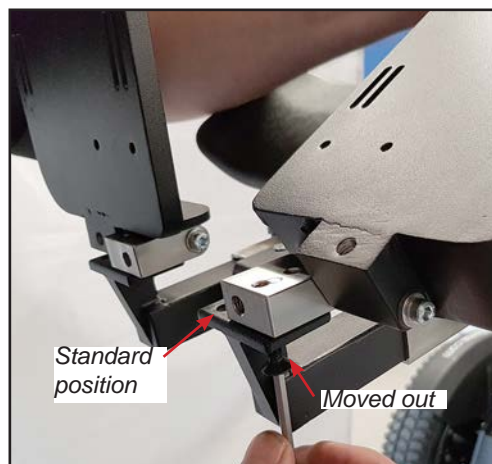

Side-to-side adjustment

The foot plates are mounted in the innermost position as standard, so that there is only 5 mm between them. But by moving the footplates to the outermost position, there will be 30mm more per foot plate.



Switch to the seat functions setting by pressing the Mode button.

Toggle between the settings by deflecting the joystick left / right.

Find the footrests icon and use the forward/backward joystick to adjust.

There are options for angling and extending the leg support. Adjust only for up/down legrest, and setting to angle the legrest only.



Note!

There is a risk of trapping when the footplate is moving, and especially when it move back to normal position.

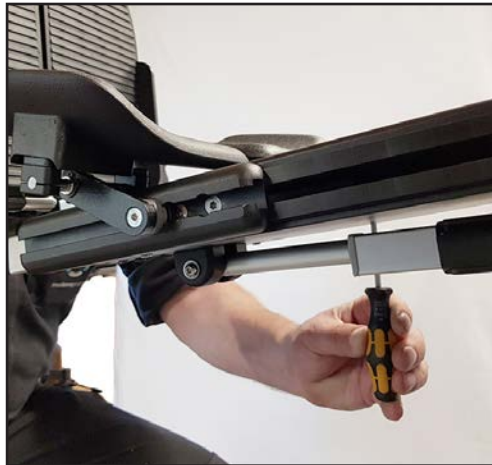

For this leg support, it is possible to adjust how far, and how fast, the foot support should move out during angling.

This is done by turning on adjustment screw 1 (how far)

Angled between -5 and +90



and adjustment screw 2 (how fast).

Manual central footplate



The footplate can be adjusted forwards/backwards.

This is done by loosening 2 screws on the inside of the C-rail, on both sides.

REMEMBER to tighten on both sides.

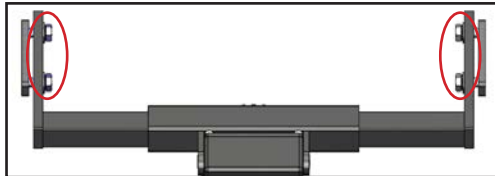

To dismantle:

- Disconnect the cables.
- Loosen the two screws in both sides, and slide the footrest of the rails.



Angle on footplate

Loosen the screws on both sides. Feel free to hold a finger on both sides while setting the correct angle. Tighten the screws again.

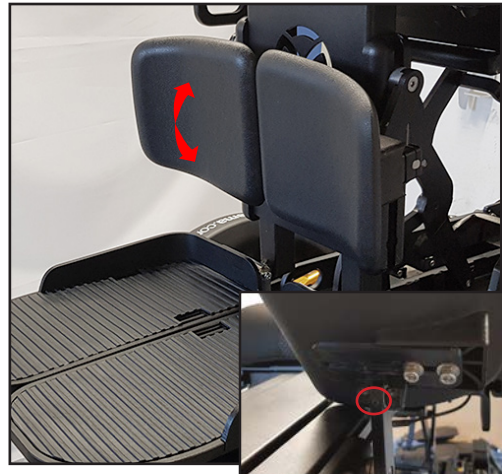

Calf pads - Angle

You set how tight the leg pad should be to tilt, by loosening or tightening this pin bolt.



Calf pads - up/down

Loosen the screw pointed out in the picture beside. Adjust and tighten again.

Travel: 210 mm from top position to lowest position.



Calf pads in/out



Loosen the screw indicated in the adjacent image. Adjust and tighten again.

Travel: 40 mm from inner position to outer position.

Electrical split footrests



The footplate can be adjusted forwards/backwards.

This is done by loosening 2 screws on the inside of the C-rail.

REMEMBER to tighten again.



Height and angle adjustment via joystick:

Switch to setting the seat functions by pressing the Mode button.

Switch between the various settings with the joystick right / left.



The icon for the left leg rest flashes, and can now be adjusted by moving the joystick up/down.

Use the joystick right / left to find the right footrest.

If both icons flash at the same time, they can be adjusted at the same time.





Adjusting calf pads up/down and the angle by loosening these two screws. Tighten again after adjusting.



Press this release handle and swing the leg rest to the side.

In this position, the leg support can be lifted off.

Note!
There are no wires to remove.



The height can be adjusted manually by loosening these screws, adjusting and retightening.

Note! The footrest **MUST** be mounted with 2 screws. Do not adjust it so far out or in that only a single screw is used for fastening.

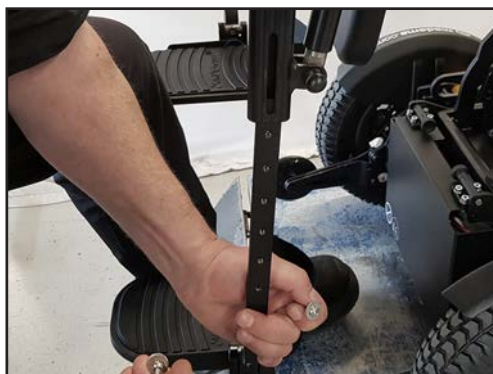



The angle of the footplates can be manually adjusted by loosening this screw, adjusting and retightening.

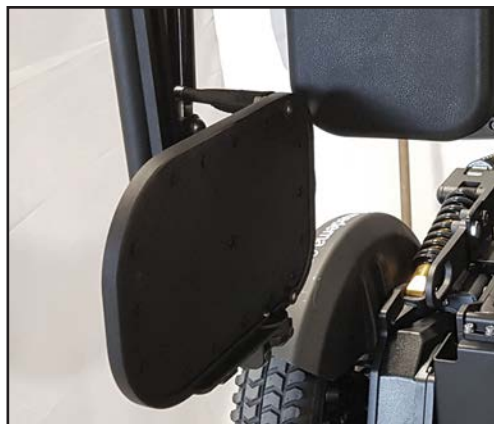

Without tools, the footplate can be folded up and provide more space for the legs when getting in and out.

Manual split footrests



The footrests can be adjusted forwards/backwards. First loosen the two screws shown in the picture.

REMEMBER to tighten the screws again.

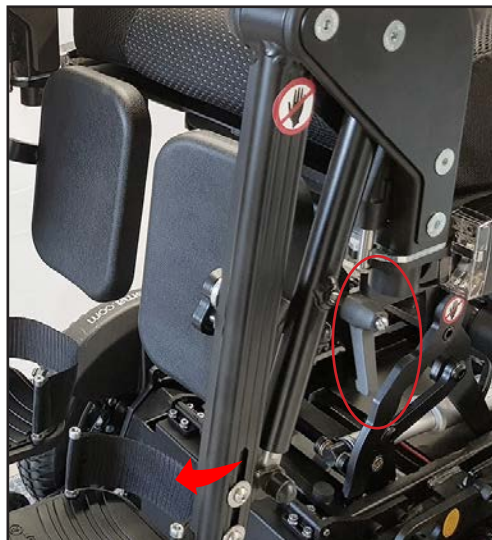

To adjust the angle, loosen the lock and the angle can be adjusted. Then lock again.



The calf pads can be adjusted in angle, as well as up/down by loosening these two screws, adjusting and tightening again.

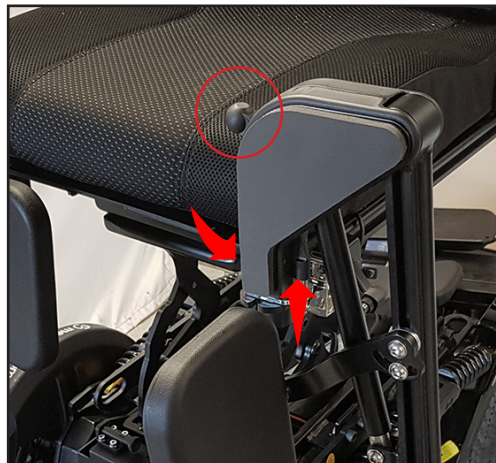

Press this release handle and swing the footrest to the side.

In this position, the footrest can be lifted off.

Note!

There are no wires to remove.



The height can be adjusted manually by loosening these screws, adjusting and retightening.

Note! The footrest **MUST** be mounted with 2 screws. Do not adjust it so far out or in that only a single screw is used for fastening.



Spinalus-3 settings



Spinalus-3 is designed to stay safe to use for at least 10 years

Adjusting the height of the backrest



The backrest can be adjusted up/down in several sections.

The top part of the backrest is, from the factory, mounted in the top hole. Can be moved one hole down (30 mm)

The backrest itself is, standard wise, mounted in the middle adjusting hole. From here it can be moved 25 mm up or down.

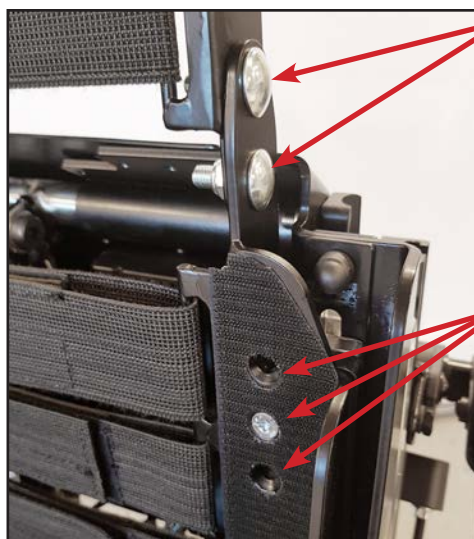

Adjusting holes for the top part of the backrest.

Tool: open end wrench
13 mm

Adjusting holes for the backrest.

Tool: Torx T30

Stepless adjustment of seat depth



Seat depth are step less adjusted between 35 and 55 cm.

Due to the construction of the back, the seat depth adjustment have no influence on the other geometry in the backrest.

At the back of the backrest is a zipper. Open the zipper

and strip the backrest cushion of from the top back frame. Pull the cushion from the velcro, fixed to the back frame. and it is free.

The seat cushion is also fixed with velcro in both sides, so lift it



off easily and remove it.

The backrest is fixed to the seat with two screws on each side.

Loosen the screws on both sides.

Tool: open end wrench 13 mm

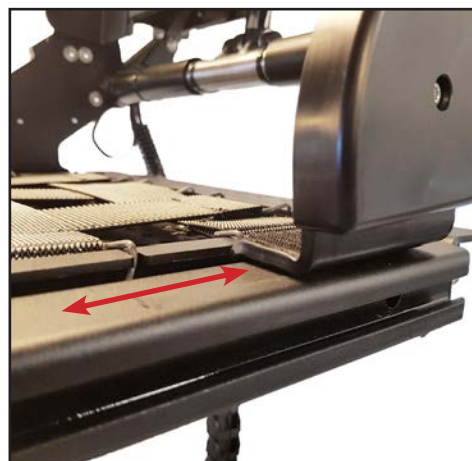

Now the backrest can be moved back/forward, to the desired position.



Adjustment of armrests



Forward/backward

Adjust the armrest forw./backw. Loosen these two screws - adjust - tighten the screws again.

Further forward

Remove the armrest, see above, and turn the bracket 180° by loosen the screw - turn bracket - tighten screw again.



Angle up/down (first joint)

Loose the screw - adjust - and tighten the screw again.



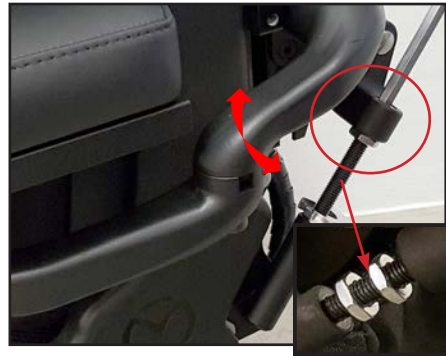

Angle up/down (second joint)

Loosen the two nuts, and by screwing the screw in or out the angle changes.

By using the Angle up/down in both first and second joints in combination, you can raise or lower the armrest.

Angle in/out

Loosen the two sucket set screw so they are not visible in the "window".



Window

Pin screw



And loosen this bolt too.



Adjust angle, and tighten the bolt and the two sucket set screws again.

Armrest up/down

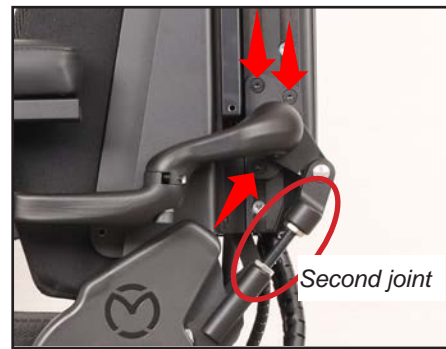

Adjust the armrest up/down. Loosen these three screws - adjust - tighten the screws again. Adjust the angle up/down in second joint, to make the armrest level again. See earlier description.

Dismantling the armrest



Remove the armrest completely, by loosen the sucket set screw that holds it in place.

Flip the armrest up, and find the sucket set screw.

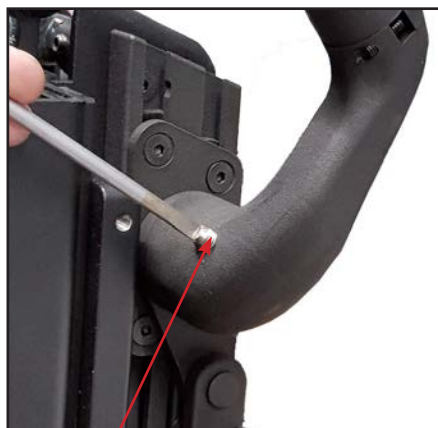

Sucket set screw. Loosen it. Remove armrest.

Remember to disassemble cable to joystick or any accessories..

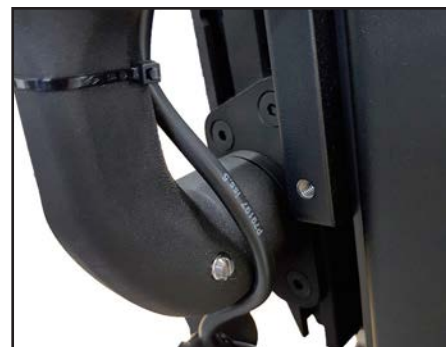

Adjustment of the seat width



The Spinalus-3 seating system is full modular seating system from 40 to 55 cm in seat width. In steps of 5 cm.

When changing from one seat width to another, all that need to be changed, is the cushions.

Under the seat, and back cushions there is webbings

that can be adjusted for good comfort, and adjustable for varies seat widths. The upper part of the backrest, can be angled forward or backward.

The back has an adjustable dynamic recline which means that the back moves down at the same time as it is angled backwards. It is a sliding function that compensate for change of position and reduce the displacement.

The armrests follow the back and also have a dynamic movement that ensures that they are held parallel when the back is angled. The armrests are available in many different lengths and can be adjusted steplessly back and forth.

The seat depth can be adjusted steplessly from 35 to 55 cm. Due to the construction of the back, the seat depth regulation has no influence on the other geometry in the back.

Contact an authorized service technician if the width of the seat is to be changed. More information can be found in the Service Manual.

Dynamic recline

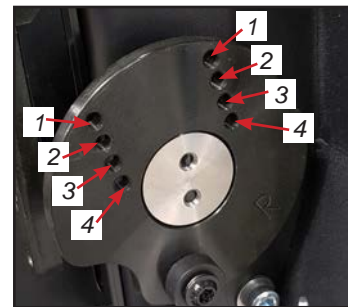

In the outer holes (hole 1) the seat back is lowered 80 mm.

You can adjust how far the seat back moves down during recline. Move the two screws (in both sides) as shown in the set of holes.

Hole	Distance
1	80 mm
2	70 mm
3	50 mm
4	40 mm

Note!



The screws must be placed similar in both sides of the seat. The closer to the centre, the screws are mounted, the less the back is lowered.

Adjusting the headrest



Height adjustment: Use the thumbscrew to loosen the headrest. Adjust to the desired height - and tighten again.



The headrest can be adjusted in all joints, for optimal comfort.

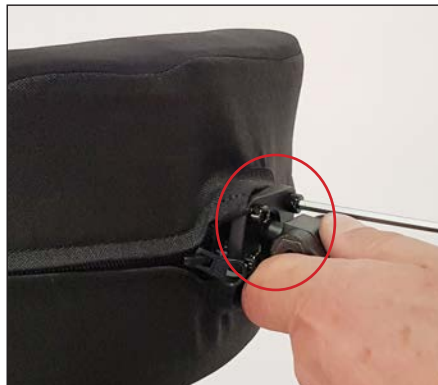

The cushion itself can be adjusted in all directions by loosening the 4 screws at the back - adjust - and tighten again.

Swing-away fitting for Spinalus-3



Our Swing away fitting for Spinalus-3 have many adjustment features, to place the joystick to fit you perfectly.

The Swing away is designed to stay safe to use for at least 10 years.

Adjusting the tightness



Here you adjust how easily the Swing away should react to the push, when you need it to swing away.

Tool: Torx T10

Adjusting backward/forward on armrest



Lift up the armrest.

Two screws keep the Swing away bracket fixed to the armrest.
Loosen the screws.

Pull / push the Joystick and Swing away to the desired position. Tighten the screws again.

Tool: Allen key 5 mm

Adjusting the joystick



The Joystick bracket is attached to a ball joint. By loosen one or both screws it is possible to twist and turn the joystick to desired position.



Joystick height adjustment



By loosening this screw, the joystick can be adjusted up / down, with center in this axis.

Tool: Torx T30



Find the right location.

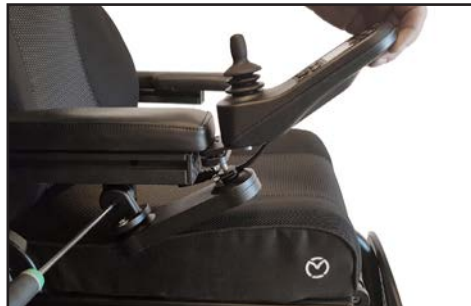

And tighten the screw again.

Tool: Torx T30



This setting also affects how far the joystick folds under the armrest.

Replace joystick



The Joystick is attached to a bracket with two screws. Remove the two screws, and unplug the plug.

Mount a new in reverse order.

Remember!
To fix the cable again with cable ties.

Tool: Allen key 4 mm

Switch joystick to opposite armrest



Remove the two screws that hold the swing away module.

Disassemble the plug.



Remove the end plug on the rail.

Let the swing away module slide off the rail.

Place it in reverse order on the other armrest.



In order to make the Swing away, swing to the other side, switch these two screws around.

Tool: Torx T25



They have different length. The longest screw should be to the right if the Swing away is mounted on the right armrest. And opposite on the left side.

Fix the cable with cable ties.

LED errors

If a system trip occurs, you can find out what has happened by counting the number of LEDs on the battery gauge that are flashing.

Below is a list of self-help actions. Try to use this list before you contact your service agent.

LED	Meaning
1 LED	The battery needs charging or there is a bad connection to the battery. Check the connections to the battery. If the connections are good, try charging the battery.
2 LED	The left hand motor has a bad connection. Check the connections to the left hand motor.
3 LED	The left hand motor has a short circuit to a battery connection. Contact your service agent.
4 LED	The right hand motor has a bad connection. Check the connections to the right hand motor.
5 LED	The right hand motor has a short circuit to a battery connection. Contact your service agent.
6 LED	The wheelchair is being prevented from driving by an external signal. The exact cause will depend on the type of wheelchair you have.
7 LED	A joystick fault is indicated. Make sure that the joystick is in the centre position before switching on the control system.
8 LED	A possible control system fault is indicated. Make sure that all connections are secure.
9 LED	The parking brakes have a bad connection. Check the parking brake and motor connections. Make sure the control system connections are secure.
10 LED	An excessive voltage has been applied to the control system. This is usually caused by a poor battery connection. Check the battery connections.
7 LED+ S	A communication fault is indicated. Make sure that the joystick cable is securely connected and not damaged.

Reconditioning

When preparing a MC 1124 for a new user it is important to check the following.

- Transaxle - clean and check for leaks. Check bearings. Check brushes in the motors.
- Tyre pressure (see technical data).
- Condition of tyres (check for cracks and abnormal wear).
- Cables (check that the cable insulation is undamaged and that no cables are trapped, secure loose cables, check for signs of heat damage).
- Control unit with joystick (check for moisture, function test).
- Batteries (load test, check battery terminals and strap).
- Charger (check that the charger is supplying the correct charge voltage/current).
- Fuses (function test).
- Moving parts like leg supports, etc. (lubricate with acid-free oil).
- Check wheels (pivot wheels, anti-tilt wheels and central wheels). Clean and check for play.
- Check the brakes/disengagement.
- Screws and washers (check screws/washers everywhere on the wheelchair. Check they are tightened properly and that they are intact).
- Hoist and tilt (check for breaks on the frame, hoist and tilt. Check that there are no cracks or breaks - must not be welded).
- Frame (check for cracks, remove any rust, repaint. Must not be welded).
- Switches (check the switch controlling the speed reduction when the hoist is activated).
- Accessories (check the accessories, manual and electronic. Replace any faulty finger screws or handles).
- Test drive (test all functions at their maximum settings. Test drive the wheelchair under maximum load).
- The user instructions must be provided in a plastic folder on the seat.

If the panels have lost their shine:

- Wipe the panels dry with a damp cloth.
- Wax them with car wax.

Further information: See the Service Instructions.

Returning electronic devices



Medema is certified in producer responsibility. It means that Medema collect and handle electronic waste in the category Medical equipment.

Technical data

MC 1124	
General information:	
Overall length with legrest (split legrest)	Min. 1200 mm / Max. 1200
Overall length with legrest (central legrest)	Min. 1170 mm / Max. 1230
Overall length without legrest	Min. 900 mm / Max. 900 mm
Overall width	Min. 610 mm / Max. 710 mm
Overall height (Hoist raised) (Hoist lowered):	Min. 1330 mm / Max. 1410 mm Min. 1030 mm / Max. 1110 mm
Overall height Low Rider (Hoist raised) (Hoist lowered):	Min. 1290 mm / Max. 1370 mm Min. 990 mm / Max. 1070 mm
Overall height incl. head rest (Hoist raised) (Hoist lowered)	Min. 1480 mm / Max. 1560 mm Min. 1180 mm / Max. 1260 mm
Overall height incl. head rest Low Rider (Hoist raised) (Hoist lowered)	Min. 1440 mm / Max. 1520 mm Min. 1140 mm / Max. 1220 mm
Total mass incl. batteries, Spinalus-3 seat (40-55 cm), electric split footrests, headrest, swing away and joystick.	174 kg 171 kg (Low Rider)
Total mass incl. batteries, Spinalus-3 seat (40-55 cm), electric central footplate adult, headrest, swing away and joystick.	171 kg 168 kg (Low Rider)
Total mass without batteries, seat, footrest, headrest, swing away and joystick.	90 kg
Mass of the heaviest part (headrest)	1,35 kg
Rated slope all directions	10°
Energy consumption (Distance)	Ca. 35 km (*)
Clearance	70 mm
Obstacle climbing	70 mm
Obstacle climbing w/locking plate for docking	55 mm
Maximum speed forward	10 km/h
Minimum braking distance from max. speed	2000 mm
Noise & temperature	
Measured sound power level (1 m. distance)	59 db
Temperature operating condition:	-25 °C til +50°C
Seat	
Seat plane angle (Spinalus-3)	Min 0° / Max 5°
Effective seat depth (Spinalus-3)	Min 350 mm / Max 550 mm
Effective seat width (Spinalus-3)	400, 450, 500, 550 mm
Hoist/tilt Raise/lower Tilt angles (***) Tilt angles optional (****)	300 mm Min -0° / Max +50° Min -5° / Max +45

MC 1124	
Seat surface height at front edge (floor to top of seat cushion) Spinalus-3 (not tilted) Standard Optional	Min 500 mm / Max 520 mm Min 465 mm / Max 485 mm
Seat surface height at front edge (floor to top of seat frame) Spinalus-3 (not tilted)	390, 430 or 450 mm
Backrest angle (Spinalus-3)	Min 0° / Max 50° (**)
Backrest height (Spinalus-3)	505 - 530 - 555 - 585 mm
Footrest to seat (top of seat cushion) distance	Min 185 mm / Max 185 mm
Leg to seat surface angle	Min 92° / 164°
Armrest to seat plate distance	Min. 180 mm / Max 320 mm
Horizontal location of axle	Centre
Minimum turning radius without legrest	900 mm
Minimum turning radius with legrest	1200 mm
Wheel sizes: Safety wheels: front Central wheels: middle Pivot wheels: back	Ø150 mm / massiv Ø350 mm / pneumatic Ø150 mm / massiv
Tyre pressure for central wheels	40.6 psi / 2.8 bar
Motor	2 motors with central drive. 200 WK - 1200 WP
Total maximum mass of user	150 kg
Suspension	Yes
Optional extras possible	Yes
Standard colour	Black
Classification	Class B
Batteries:	
Batteries	2 x 12 V / 60 Ah GEL
Battery dimensions	225 x 135 x 215 mm
Battery weight	2 x 18,5 kg
Charging time	At least 8 hours
Charger	24V DC - 10 amp
Electronic system	120 A - R-net
Lights:	
Indicators / Lights	LED

MC 1124	
The wheelchair conforms to the following standards:	
ISO 7176-15 Annex A	
a) requirements and test methods for static, impact and fatigue strengths (ISO7176-8)	Conforms
b) Power and control systems for electric wheelchairs, requirements and test methods. (ISO 7176-14)	Conforms
c) climatic test in accordance with ISO 7176-9	Conforms
d) requirements for resistance to ignition in accordance with ISO 7176-16	Conforms
DS/ISO 7176-19:2008 Wheeled mobility devices for use as seats in motor vehicles. User weight max 136 kg.	Conforms
MC 1124 Crash tested with belts from Dahl Engineering	Passed
MC 1124 Crash tested with docking system from Dahl Engineering.	Passed

() Driving distance is depending on: temperature, wind, terrain, tyre pressure and user weight.*

*Maximum driving distance with new batteries at +20° on flat, firm surface
Optimum battery capacity is reached after approx. 20 charges / discharges.*

Cassation



The MC 1124 can, for a fee, be taken to the nearest dealer for disposal in accordance with current environmental regulations.

Seat angles

**

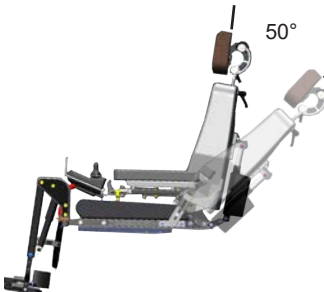

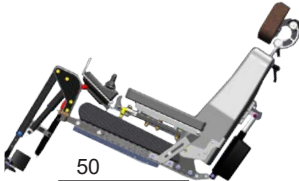
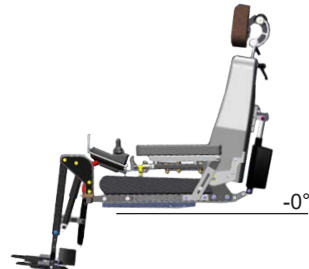

Optional

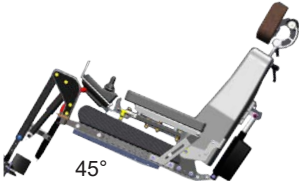
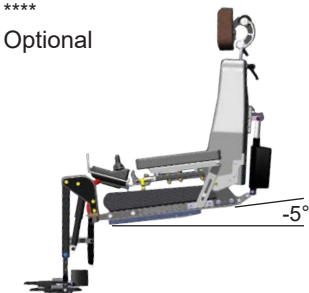

Own notes



medemagroup