

12.03.2020

BALDERTECH BALDER

Owner's Manual

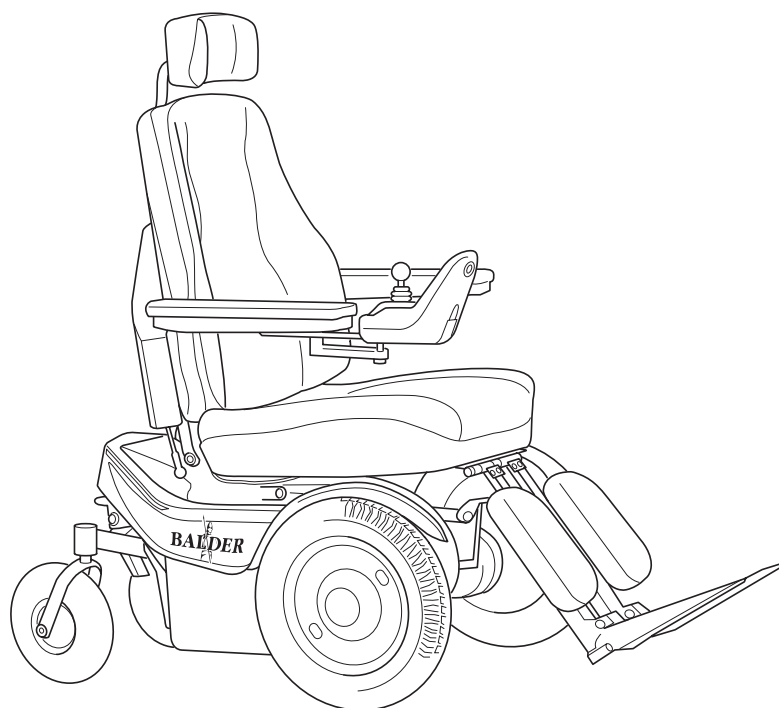

Balder

CONTENTS

1. INTRODUCTION	4
1.1. Purpose of the product	4
1.2. Making your chair ready for use	4
1.3. Individual labeling	4
1.4. Contact addresses if you require assistance	4
1.5. Use of hazard symbols	5
1.6. Available documentation	5
1.7. The environment	5
1.8. Warranty	5
1.8.1. Terms of warranty	5
1.8.2. Warranty Exclusions	6
1.8.3. Service and support	6
1.8.4. Spare parts and accessories	6
2. KEY DATA	7
2.1. Restrictions during normal use	7
2.1.1. Intended use/user	7
2.1.2. Surfaces	7
2.1.3. Obstacles, sideslopes and kerbs	7
2.1.4. Transfer in and out of the wheelchair	9
2.1.5. Parts and tools	10
2.2. Technical specifications	10
3. TECHNICAL DESCRIPTION	12
3.1. Function and operation	12
3.2. Physical structure	12
3.2.1. Joystick	13
3.2.2. Operating program	15
3.2.3. Wheelchair attachment points	15
3.2.4. Attendant control (optional)	16
3.2.5. Swing away for joystick (optional extra)	17
4. ADAPTING YOUR WHEELCHAIR	18
4.1. Adapting the armrests	18
4.1.1. Angle adjustment	18
4.1.2. Height adjustment	18
4.1.3. Adjusting the armrest pads	19
4.1.4. Adjusting the width between the armrests	19
4.2. Adapting the footrest / foot supports	19
4.2.1. Length adjustment, electric footrests	20
4.2.2. Angling the footrest plates	20
4.2.3. Foot support angling	21
4.2.4. Adjusting the width between the foot supports	21
4.2.5. Removing and pivoting out the foot supports	22
4.3. Adjusting the joystick	22
4.4. Adjusting the swing away for joystick (optional extra)	22
4.5. Adjusting the headrest (optional extra)	23

5. CHAIR OPERATION	24
5.1. Activation, normal operation and deactivation	24
5.1.1. Wheelchair activation	24
5.1.2. Deactivating the wheelchair	24
5.1.3. Operation	24
5.1.4. Operating the attendant control (optional extra)	26
5.1.5. Driving distance	26
5.2. General seat functions	27
5.2.1. Seat tilt	27
5.2.2. Seat back	27
5.2.3. Left footrest / length compensation	28
5.2.4. Right footrest / footrest angle	28
5.2.5. Seat raise	28
5.3. Stand up function	29
5.4. Interference	30
5.4.1. Checking the automatic fuse	31
5.4.2. Disconnecting the breaks/drive motor	31
6. TRANSPORT OF WHEELCHAIR AND USER IN CAR	32
6.1. General occupant restraint Instructions	33
6.2. Securing the chair in a car with a 4 point strap tie-down system	34
6.3. Using a docking system (optional extra)	35
6.3.1. Dahl Docking System	36
6.3.2. Balder Docking System	38
6.4. Transportation by air	39
6.4.1. Preparations prior to transportation by air	39
7. STORAGE	40
8. MAINTENANCE	40
8.1. Maintenance – Overview	40
8.2. Maintenance procedures	40
8.2.1. Battery charging	40
8.2.2. Frame and body cleaning	41
8.2.3. Seat cleaning	41
8.2.4. Releasing the seat	41
8.2.5. Disconnecting the batteries	42
8.2.6. Fitting the batteries	42
8.2.7. Tire	42
9. TROUBLESHOOTING	44
10. OPTIONAL EXTRAS	45
11. CONTACTS	46

1. INTRODUCTION

1.1. Purpose of the product

Balder wheelchairs are multi functional electric wheelchairs which are very comfortable and highly flexible in terms of functionality. Balder wheelchairs combine the qualities of an outdoor chair with the flexibility of an indoor model and are designed for daily use in all situations. Expected lifetime for this product is 5 years. The lifetime presupposes recommended use and maintenance.

1.2. Making your chair ready for use

Before you start to use your chair, we recommend that you make sure your chair is adjusted to meet your own specific needs. Each chair comes with simple control and adjustment options to help you sit as comfortably as possible. Find out more about the control and adjustment options in the technical description.

1.3. Individual labeling

All Balder wheelchairs are labeled individually with their own unique serial number. This is located on the chassis, between the front wheels.

Always quote the serial number of your chair if you require any assistance.



1.4. Contact addresses if you require assistance

Contact your local dealer or the Assistive Device Centre in your district if you need any assistance or spare parts. See also the troubleshooting list in section 9, and section 11. Contacts.

1.5. Use of hazard symbols

All warnings must be heeded in order to avoid injury to people or damage to machinery or the environment. The following three hazard symbols will be used in this book.



DANGER

If you do not follow these instructions, staff WILL be **seriously** injured.



WARNING

If you do not follow these instructions, machinery WILL be **seriously** damaged.

NOTE

If you do not follow these instructions, staff MAY be injured or machinery or the environment MAY be damaged.

1.6. Available documentation

If you have problems reading this manual, it is also available in electronic format so that the text and pictures can be enlarged, etc. if so required. Contact your local dealer if you need an electronic copy. This manual and complete Technical Handbook including Service information is also available for download as a PDF file from our website www.baldertech.com.

1.7. The environment

These chairs must be sorted at source in accordance with applicable regulations on waste. Batteries and electronic equipment in particular must be taken into account.

1.8. Warranty

All wheelchairs are supplied with a two year product guarantee. Battery and charger are supplied with one year warranty. If parts need to be replaced or repaired due to construction error or material defects within two years from the date of delivery, this will be executed and covered by Baldertech.

1.8.1. TERMS OF WARRANTY

Fulfillment of the warranty by Baldertech AS is conditional on the following terms:

Adjustments, service, and maintenance must be carried out by Baldertech AS authorized service partners.

The products must be used for their intended purpose in accordance with the Owner's Manual.

Repairs and maintenance must be carried out by skilled service personnel.

1.8.2. WARRANTY EXCLUSIONS

The Baldertech AS warranty does not apply in the following circumstances:

- If the terms of the warranty are not met
- Incorrect use of the wheelchair
- Incorrect storage and transport
- Incorrect adaptations or use of parts not supplied by Baldertech AS
- Repairs or adaptations carried out by non-Baldertech AS authorized personnel
- Damage caused by force majeure
- If the service schedule is not followed

1.8.3. SERVICE AND SUPPORT

We recommend the wheelchair to be inspected by an authorized service partner once per year for your own safety and for the wheelchair to function smoothly.

All Baldertech wheelchairs are identified with a unique serial number on the product label. The product label can be found on the chassis, between the front wheels.

Always provide the serial number when contacting your supplier.

If you are in need of technical support, please contact your dealer. See "Contact Information". See "Routine Maintenance" form in Balder Service Information.

Information regarding service and repair:

Performed by	Type of service/repair
User	None
Serviceman / caretaker	Change of batteries, wheels and basic repairs and maintenance.
Authorized service personnel and manufacturer.	Change of actuators, programming and other repair that needs technical skills.
Manufacturer	If the chair have been exposed for unintended use like hit by car or other similar cases.

The manufacturer has no exchange module arrangement available.

1.8.4. SPARE PARTS AND ACCESSORIES

Spare parts and accessories for your wheelchair can be ordered from Baldertech, or your dealer. See "Contact Information".

Expected lifetime for this product is 10 years. The lifetime presupposes recommended use and maintenance.

2. KEY DATA

2.1. Restrictions during normal use

2.1.1. INTENDED USE/USER

- All Balder wheelchairs are designed to transport one – 1 – person.
- The wheelchair's maximum load depends on the model and is specified on the product label, maximum load must not be exceeded.
- **Never allow anyone else to ride with you, either behind you or on the footrests.**
- Balder series is class B of wheelchairs, and are intended for indoors- and limited outdoors use.
- The user must have cognitive, physical and visual abilities to safely drive and control the wheelchair in a maximum slope of 6°. If you are in doubt if the wheelchair is suitable to your usage, contact your supplier.
- Balder F and Junior series are offered in several models with user weight up to 120 kg. The product label provides information on user weight, model, type, serial number and year of manufacture.

2.1.2. SURFACES



DANGER

Take care when using the wheelchair on uneven, wet or slippery surfaces (gravel, loose sand/earth, wet grass, etc.). These are conditions in which you could overturn or lose control of your chair.

Bear in mind that negotiating obstacles can involve a risk of overturning.

Remember that your chair is heavy. Do not travel in areas where there is a risk of the surface on which you are traveling collapsing.

Avoid traveling through water more than 7 cm deep. This may damage the electric motor and systems, as well as the battery.

When traveling on slopes in excess of 6 degrees, remember that this will affect the stability of the chair and there is a risk of the chair overturning.

2.1.3. OBSTACLES, SIDESLOPES AND KERBS

NOTE

When your vehicle drives downhill, the motor generates energy. This energy charges the battery. However, if the battery is already fully charged, it cannot accept the generated energy anymore.

When this happens the battery voltage becomes too high, which can result in damage to either the controller or the batteries. The controller will try to prevent this damage and if needed it will ultimately force the vehicle to halt abruptly.

When you go downhill at a slower speed, the motor will generate less energy. The batteries will have more time to absorb this energy before they are fully charged. This will reduce the risk of a sudden halt, and it will extend the life of the batteries.

To have a smooth journey downhill:

- Select a drive profile that has a lower maximum speed
- If your vehicle has lights, turn them on. The lights will use energy, and as a result less energy will go to the batteries. This allows you to go downhill at a slightly faster speed than with the lights off.
- When the LEDs of the battery gauge start to flash as a warning that the batteries are overcharging, do not ignore this warning. Drive at a lower speed. If you do not slow down, you will damage the batteries. When your speed has been too fast for too long, the vehicle will halt to prevent more damage.
- If you often need to go downhill with fully charged batteries, ask your installer/technician/therapist to optimize the program values of your chair for your situation.

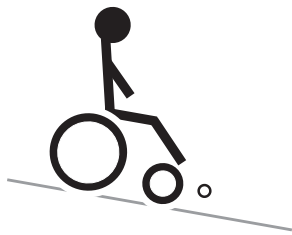

Driving downhill

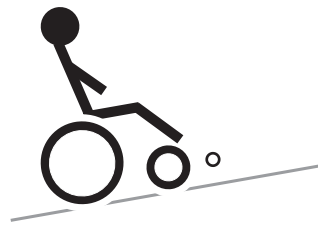

Driving uphill

Driving on sideslopes

Avoid, if possible, to drive on sideslopes. Driving on sideslopes must be carried out with great caution and low speed. Show great caution on slopes with uneven surface such as gravel, sand, snow, grass and like.

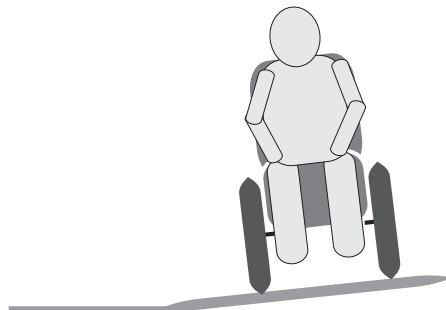

Driving on sideslopes



WARNING

Do not drive on sideslopes greater than 6 degrees. There is risk of tipping. Use of seat lift, seat angle and backrest angle shifts the center of gravity and increases the risk of tipping.

Driving over obstacles and kerbs

Do not drive over obstacles higher than 50mm.

Models that have seat lift, backrest angle and seat angle, the center of gravity will shift when using these, and increases the risk of tipping. Use seat lift, backrest angle and seat angle only on flat surfaces.



WARNING

Make sure to sit as far back in the seat as possible. Make sure no loose clothing such as scarves, jackets or similar are hanging down the sides of the wheelchair. They can easily get caught. Use of seat lift, seat angle and backrest angle shifts the center of gravity and can affect driving performance negatively.



WARNING

If you turn or change direction at high speed, the chair can overturn and cause injury. The danger increases at high turning speed, sharp turns and quick changes of direction. The risk also increases when changing road surfaces with different friction, eg. from grass cover to asphalt. Always drive at a slow speed in turns, change of direction, and like.



WARNING

If the wheelchair is acting abnormal, turn it off and contact authorized service personnel

If possible, use ramps to avoid obstacles. Steps and kerbs must only be traversed at reduced speed and with great caution. Always traverse obstacles at a right angle.

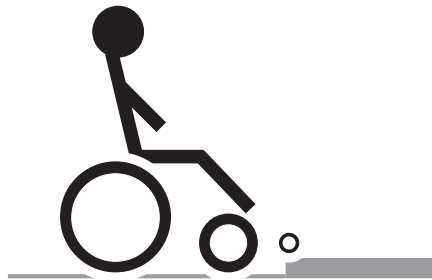

Driving over obstacles and kerbs

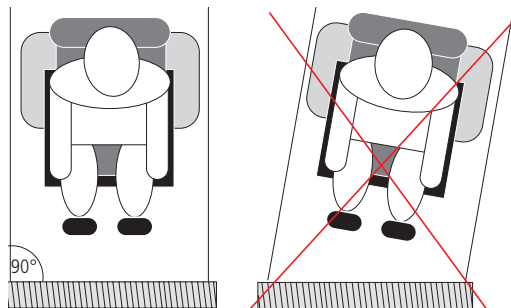

Driving over obstacles and kerbs

2.1.4. TRANSFER IN AND OUT OF THE WHEELCHAIR

Make sure the power is turned OFF before entering or leaving the wheelchair. Raise the footrests and the armrests to make it easier to sit down.

Every precaution should be taken to reduce the distance between the wheelchair and the place to which the user is transferring. Overextending the distance, may cause a risk of falling or losing balance.

Never use the joystick, foot plates or armrests as support when you move in or out of the wheelchair, as these are not designed to take heavy loads. We recommend that a person is present who can oversee and help if need.

Place the seat surfaces as close together as possible. Slide your body to the other seat surface if you are moving in / out from the side. Turn your body if you are going in / out from the front.



Getting in and out

2.1.5. PARTS AND TOOLS

The manufacturer of the Balder range wheelchairs states that the wheelchair does not have parts or accessories intended to be removed without the use of tools, that will have adverse or beneficial effects for the wheelchair.

Balder range can primarily not be dismantled without using tools, and parts are not to be removed unless it is mentioned in the user manual.

Certain models can have removable parts without tools f.ex:

- Seat cushion, 2,76 kg
- Seat back cushion, 2,72 kg
- Neck support, 0,66 kg
- Abduction pad 1,0 kg

2.2. Technical specifications

Description	Balder Junior	Balder Junior Stand up	Balder Finesse	Balder Finesse Stand up
Width	64 cm	64 cm	64 cm	64 cm
Length without foot support	88,3 cm	104 cm	88,3 cm	104 cm
Length with foot support, fully retracted	111 cm	111 cm	118 cm	118 cm
Seat width	30 - 35 cm	32,5 cm	40 - 48 cm	40 - 48 cm

Seat depths	35 - 40 cm	37,5 cm	40 - 52,5 cm	40 - 52,5 cm
Seat height ex/seat pad	36 - 78,5 cm	36 - 78,5 cm	35 - 78,5 cm	35 - 78,5 cm
Back height	40 - 42 cm	41 cm	44 - 62 cm	44 - 62 cm
Height beneath chassis	7 cm	7 cm	7 cm	7 cm
Axle spacing	61,5 cm	61,5 cm	61,5 cm	61,5 cm
Weight	126 kg	130 kg	130 kg	140 kg
Max. user weight	75 kg	75 kg	120 kg	100 kg
Back angling	0° to 90°	0° to 90°	0° to 90°	0° to 90°
Tilt	-15° to 45°	-15° to 15°	-15° to 45°	-15° to 15°
Foot support angling	0° to 90°	0° to 90°	0° to 90°	0° to 90°
Max obstacle height	50mm	50mm	50mm	50mm
Max speed	7 km/h	7 km/h	7 km/h	7 km/h
Max range	35 km	35 km	35 km	35 km
Front wheels, dimensions	3 x 8"	3 x 8"	3 x 8"	3 x 8"
Rear wheels, dimensions	2,5 x 3"	2,5 x 3"	2,5 x 3"	2,5 x 3"
Front wheels, air pressure	206,84 kPa	Puncture-free	206,84 kPa	Puncture-free
Rear wheels, air pressure	344,74 kPa	Puncture-free	344,74 kPa	Puncture-free
Turning width (pivot width)	1100 mm	1100mm	1100mm	1100mm
Class	B	B	B	B
Maximum slope	6°	6°	6°	6°
Batteries	A512/55A 12V	A512/55A 12V	A512/55A 12V	A512/55A 12V
Weight of batteries	18 kg x 2	18 kg x 2	18 kg x 2	18 kg x 2

Tested to the following standards

EN 12184 And the underlaying standards.

ISO 1021 1/2 All fabrics are resistance to ignition.

3. TECHNICAL DESCRIPTION

3.1. Function and operation

Balder wheelchairs are electric. The electric functions of this chair are controlled by joystick or function switch.

Balder Finesse and Balder Junior are available with a vertical function. See section 5.3.

3.2. Physical structure



DANGER

Do not remove or disassemble equipment which may affect the operation and/or functions of the chair. Contact authorized personnel if you require assistance.

The illustration shows the Balder Finesse, but the structure is also applicable to the Balder and Junior. The Balder Finesse and Balder Junior are electric wheelchairs with front wheel drive.



Key:

1. Neck support

2. Back

3. Joystick

4. Seat

5. Leg pads

6. Footplates

7. Battery (located beneath the chassis)

8. Armrests



WARNING

Do not perform any maintenance other than described in this manual. Service, programming of control systems and more, must be carried out by authorized personnel approved by Baldertech.

Incorrect settings can make the wheelchair unstable. This may result in loss of warranty.



WARNING

Situations who requires service such as programming, mechanical complex parts, actuators, motors and devices who can affect the safety, has to be carried out by authorize service personnel.

3.2.1. JOYSTICK

The chair is supplied with a programmable joystick. This joystick is programmed by the manufacturer depending on the specifications of the chair. The electrical functions are controlled using the control panel or external panel. Upon activation of the ON/OFF button, the wheelchair turns into drive mode. Driving directions and control of seat adjustment are carried out by using joystick and buttons on the control panel. Programming of the control system can only be carried out by authorized Baldertech service personnel. Incorrect programming can lead to uncontrolled and/or unstable driving characteristics.

3.2.1.1. Dolphin joystick









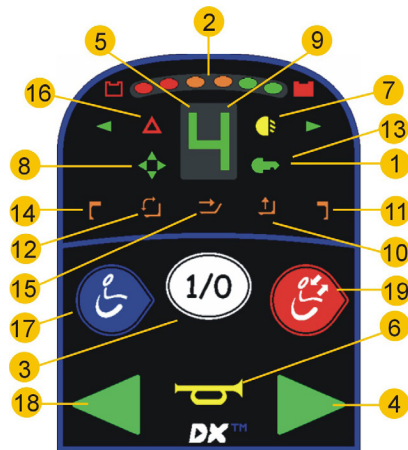











1	System status / indicator lamp (grønn)		9	Right footrest / footrest angle	
2	Battery indicator *)		10	Seat tilt	
3	On/off switch		11	Key function (sensor)	
4	Right indicator (accessory)		12	Left footrest / length compensation	
5	Program selection display		13	Seat back angle	
6	Horn		14	Hazard warning lights (accessory)	
7	Lights (accessory)		15	Program selector	
8	Seat raise		16	Left indicator (accessory)	

*) 3 red, 4 yellow and 3 green LEDs will be on when the battery is at full capacity. These will gradually go out as the remaining battery capacity is reduced.

3.2.1.2. Joystick G90



1	System status / indicator lamp		11	Right footrest / footrest angle	
2	Battery indicator *)		12	Seat tilt	
3	On/off switch		13	Key function (sensor)	
4	Right indicator (accessory)		14	Left footrest / length compensation	
5	Program selection display		15	Seat back angle	
6	Horn		16	Hazard warning lights (accessory)	
7	Lights (accessory)		17	Program selector	
8	ECU Mode (accessory)		18	Left indicator (accessory)	
9	Light Mode (accessory)		19	ASK (seat functions, Lights, ECU)	
10	Seat raise				

*) 2 red, 2 yellow and 2 green LEDs will be on when the battery is at full capacity. These will gradually go out as the remaining battery capacity is reduced.



WARNING

Driving characteristics of an electric wheelchair can be affected by electromagnetic fields (mobile phones or other devices that emit electromagnetic noise). If possible, should such devices be turned off while the chair is in drive mode.

Charging socket can only be used to charge and lock the wheelchair. Outlet must not be used as a power source for any other electrical equipment.

3.2.2. OPERATING PROGRAM

This chair is preprogrammed with five different default operating programs. The illuminated display shows the program or function that you are using.



The operating program is selected by pressing the program selector switch.

The various operating programs are as follows:

1. An operating program in which emphasis is placed on quiet movements and low speed, a typical program which can be used where there is not much space and precise movement is important.
2. An operating program very like program 1, but with slightly faster reactions to joystick movements.
3. An operating program defined according to average values. This program is ideal the first time you use the chair.
4. Programs which are intended to be used as standard once you have learned how the chair reacts and feel secure in all situations. This program is created to allow rapid feedback to your control operations, maximum speed and rapid application of the motor brake.
5. This program is designed for outdoor operation and gives maximum forward propulsion without being too sensitive to minor corrections.

3.2.3. WHEELCHAIR ATTACHMENT POINTS

There are attachments on the wheelchair – 2 in front (1) and 1 ring (2) at the rear. These are indicated by means of symbols as shown in the illustration.

In Front

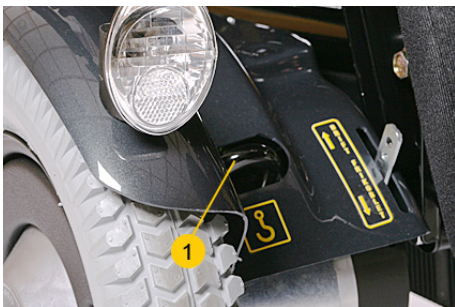

Back



For securing the wheelchair during transportation, see section 6.

3.2.4. ATTENDANT CONTROL (OPTIONAL)

All Balder chairs are available with attendant control. This guide describes a standard attendant control. See also section 5.4.1 for more information.

Attendant control

1. Fixing bracket
2. Panel for electrical functions
3. Ring for moving the wheelchair forwards or backwards.
4. Speed regulator
5. Ring for turning the chair
6. Switches for changing the attendant control angle
7. Rotary switch for selecting whether the user or the escort is to control the chair

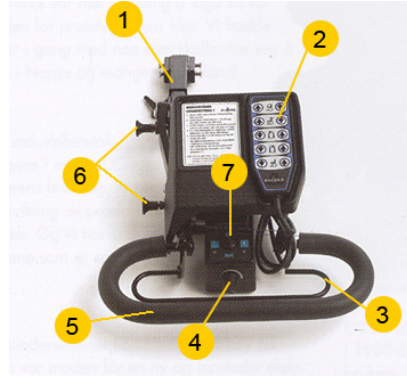

3.2.4.1. Fitting / removal

If the chair is fitted with a removable attendant control, this can be attached/removed as follows.

Attendant control:

Fitting:

1. Place the attendant control in the groove at the back of the chair (1).
2. Tighten the stop screw (2).
3. Connect the cables for the joystick, control panel and if possible the main circuit switch (4).
4. Change the angle of the attendant control by pulling out the switches (3) and adjusting it. Release the switches when the required angle has been attained.

Removal:

1. Remove by loosening the stop screw (2).
2. Disconnect the cables to the joystick, control panel and if possible the main circuit switch (4).
3. Pull the attendant control out of the groove (1).

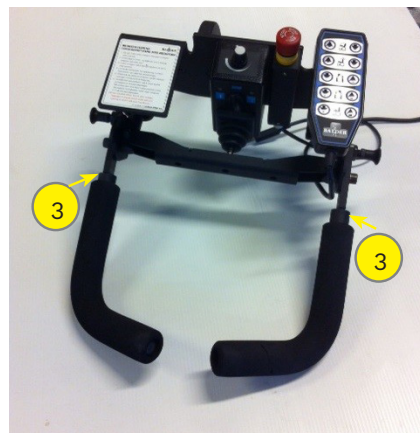
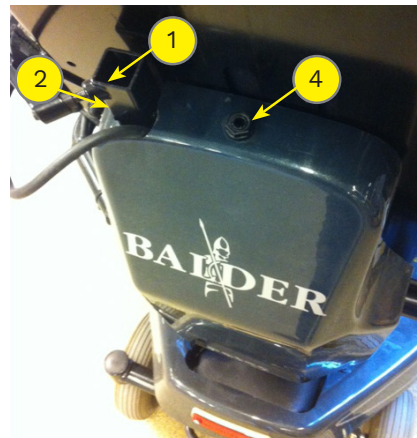

3.2.5. SWING AWAY FOR JOYSTICK (OPTIONAL EXTRA)

Swing away for joystick:

All Balder chairs are available with swing away (1) for the joystick.

The swing away makes the positioning and accessibility of the joystick more flexible.

See section 4.4 for a description of the fitting and adjustment of this.



4. ADAPTING YOUR WHEELCHAIR

Before starting to use your wheelchair, it is important to make sure that it is adjusted to suit you so as to ensure optimum comfort. You will be helped with this when your chair is delivered. If you want to change your chair settings afterwards, you can do this by contacting either your supplier or other suitable staff.

4.1. Adapting the armrests

For optimum comfort, it is important that you find the ideal position between resting and supporting your arms without restricting your freedom of movement.

4.1.1. ANGLE ADJUSTMENT

Balder Finesse

1. Undo the screws (1) on the back cover.
2. Remove the back cover.
3. Loosen the nut and adjust the screw (2) to change the angle of the armrest tubes, and also the height.
4. Do the same for the armrest on the other side.
5. Tighten the screws, place the back cover (1) in position.

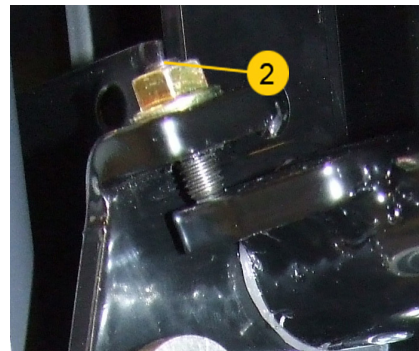
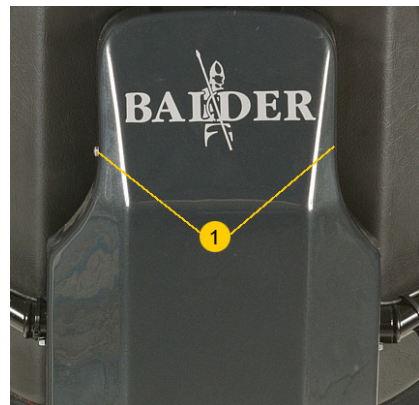

4.1.2. HEIGHT ADJUSTMENT

Balder Junior

1. Undo the locking screw (1) beneath the armrest.
2. Push the armrest up or down to adjust the height.
3. Tighten the locking screw (1).

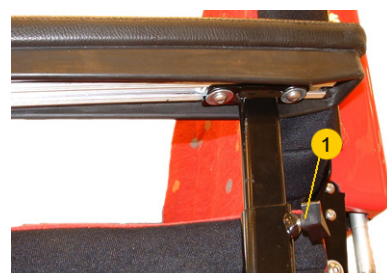

4.1.3. ADJUSTING THE ARMREST PADS

Balder Finesse

1. Undo the screws (1) so that the pad is loosened from the fixing bracket.
2. Push the pad into the required position.
3. Tighten the screws (1).

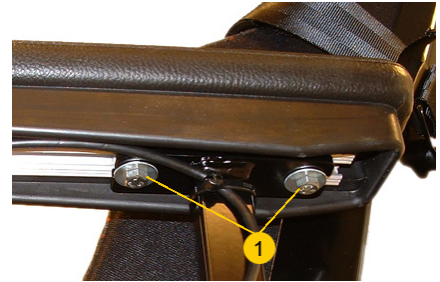

Balder Junior

1. Undo the screws (1) so that the cushion is loosened from the fixing bracket.
2. Push the pad into the required position.
3. Tighten the screws (1).



4.1.4. ADJUSTING THE WIDTH BETWEEN THE ARMRESTS

NOTE

Balder Junior only.

Balder Junior

1. Loosen the locking screw (1).
2. Adjust the bracket (2) which holds the armrest at the required width.
3. Tighten the locking screw (1).
4. Do the same for the other armrest.

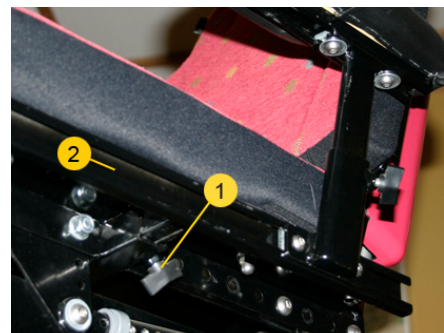

4.2. Adapting the footrest / foot supports

All Balder chairs can be supplied with different types of footrest, both manual and electric. The type of footrest selected is dependent on – among other things – what other equipment or functions the chair has. See the description for the type of footrest with which your chair is fitted.

Adjustment is best carried out with the knee at an angle of 90 degrees, as this will give the most correct relationship between the length and angle of the footrest.

4.2.1. LENGTH ADJUSTMENT, ELECTRIC FOOTRESTS

Electric footrests

1. Loosen the setting screws (1) at the back of the brackets for footrest plates.
2. Adjust to the required height.
3. Tighten the setting screws (1).
4. Test the footrest function once the footrests have been adjusted by moving them to their outermost positions.

The illustration shows a footrest with electric tilt and length compensation, but this procedure is the same for all electric footrests.

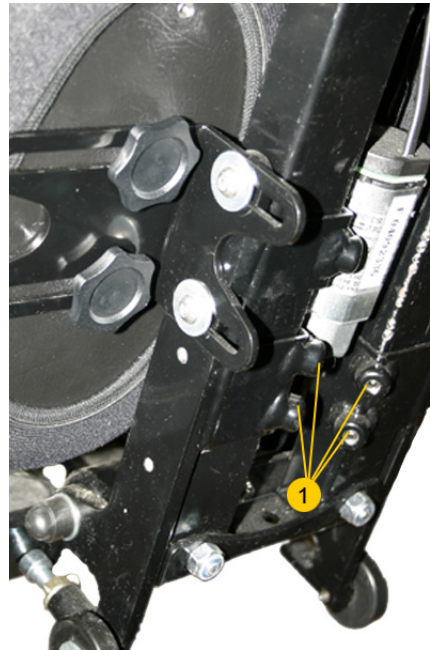

Manual footrests

1. Remove the locking screw (1).
2. Adjust the lower part of the footrest to the desired position.
3. Replace the locking screw (1)
4. Repeat the same procedure for the other footrest.

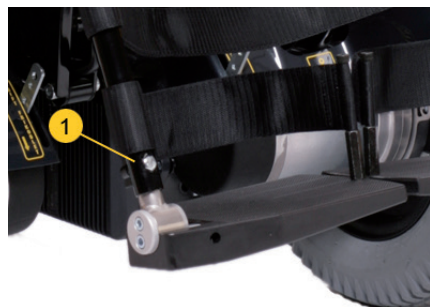

4.2.2. ANGLING THE FOOTREST PLATES

Electric footrests

1. Loosen the nuts (1).
2. Turn the adjusting screw (2) counterclockwise for a steeper angle, or clockwise for a less steep angle.
3. Tighten the nut (1).

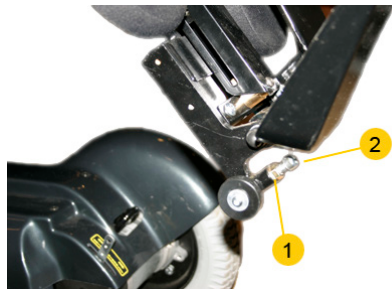

Manual footrests

1. The angle of the footrest plate is adjusted undoing the screws (1) on the respective footrest plates and moving the footrest plate to the required position.



4.2.3. FOOT SUPPORT ANGLING

Electric footrest:

The angle of electric foot supports is adjusted using a joystick. See section 5.2.4 on the use of the joystick.

Manual footrests

1. Remove the locking clip (1) beneath the seat.
2. Move the foot supports (2) to the correct position.
3. Tighten the locking clip (1).
4. Repeat the same procedure for the other foot support.



4.2.4. ADJUSTING THE WIDTH BETWEEN THE FOOT SUPPORTS

Manual footrest

1. Loosen the attaching screw (1).
2. Move the foot supports sideways.
3. Tighten the attaching screw (1).
4. Repeat the same procedure for the other foot support.



4.2.5. REMOVING AND PIVOTING OUT THE FOOT SUPPORTS

NOTE

Applicable to manual foot supports.

- The foot support can be pivoted out by lifting it up from the attaching bracket and pivoting it out.
- The foot support can be lifted off by lifting it up and off the attaching bracket.

4.3. Adjusting the joystick

For optimum comfort, it is important for the joystick to be positioned correctly in relation to the arm of the user.

Balder Finesse and Junior

1. Undo the screws (1 and 2).
2. Adjust the location of the bracket according to how far forward you want the joystick to sit on the armrest.
3. Tighten the screws (1 and 2).

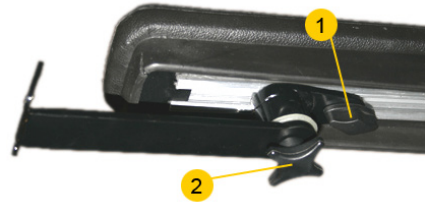

NOTE

You have to undo both screws in order to adjust the joystick forwards and back, but to angle merely undoing the screw (2) using a star grip is sufficient.

4.4. Adjusting the swing away for joystick (optional extra)

NOTE

You can lower the joystick by a maximum of 20 mm from its highest position.

NOTE

After adjusting it, you must check that the swing away for joystick can be pivoted without coming into contact with other elements of the chair, and that cables are able to move freely.

NOTE

When you adjust the stop point, you must make sure you do not remove the seal.

Tightening the swing away

1. Move the joystick carefully while tightening the hex screw (1).
2. Stop when you feel the joystick becoming fixed in position.

NOTE

Do not turn the adjusting screws so far that they bottom out.



Height adjustment of the swing away

1. Clamp the joystick.
2. Loosen the screw (1).
3. Raise or lower the joystick.
4. Tighten the screw (1).



Depth adjustment of the swing away

1. Clamp the joystick.
2. Loosen the screws (2).
3. Move the joystick / swing away to the required position.
4. Tighten the screws (2).

Adjusting the stop point

1. Undo the two hex screws (1), one on either side.
2. Move the joystick / swing away to the required position.
3. Tighten the screws.

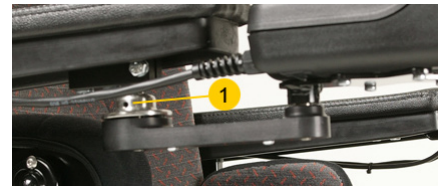

4.5. Adjusting the headrest (optional extra)

To make the seat as comfortable as possible, it is important to set the headrest correctly.

Balder Finesse and Junior:

NOTE

To achieve the correct depth, it is important for the height to be adjusted correctly in relation to the angle joint.

The headrest has three angle joints for individual adjustment. By loosening the screws (1) you can change the angle, height and distance from the backrest. Move the headrest to the right position and tighten the screws.



5. CHAIR OPERATION



DANGER

If the chair is exposed to direct sunlight or other heat sources, there may be a risk of burning.

5.1. Activation, normal operation and deactivation

5.1.1. WHEELCHAIR ACTIVATION

Action	Balder Junior and Finesse		
<p>Make sure that the release handles are in Operation position (1).</p> <p>Press the On/off switch (2).</p> <p>Activate the key function (3) if the chair is fitted with this by moving the magnetic key over the key symbol on the joystick.</p>			
	<table border="0" style="width: 100%;"> <tr> <td style="text-align: center; width: 50%;">Dolphin joystick</td> <td style="text-align: center; width: 50%;">Joystick G90</td> </tr> </table>	Dolphin joystick	Joystick G90
Dolphin joystick	Joystick G90		
	<table border="0" style="width: 100%;"> <tr> <td style="text-align: center; width: 50%;"> </td> <td style="text-align: center; width: 50%;"> </td> </tr> </table>		

5.1.2. DEACTIVATING THE WHEELCHAIR

1. If the chair is fitted with a key function, move the magnetic key over the key symbol on the joystick to deactivate the display and wheelchair.
2. Switch off the power by pressing the On/off button.

5.1.3. OPERATION



DANGER

When traveling on slopes in excess of 6 degrees, remember that this will affect the stability of the chair and there is a risk of the chair overturning.

Never switch off the chair while it is moving, as this will result in an unpleasant abrupt stop.

NOTE

When you release the joystick, it will automatically return to the default position and the chair will stop.

NOTE

To make traveling in the chair as comfortable as possible, for as long as possible, do not focus on your hand and how it is moving.

1. Select an operating program by pressing the program selector switch.
2. Control the chair by moving the joystick. The more gently you move the joystick, the more slowly the chair will react.

-
1. Turn the power on.



-
2. Check the seat function by pressing the program button.



-
3. Move joystick sideways to choose function.
 4. Move joystick forwards and backwards to check function.



-
5. Check driving performance by press program button.
 6. Move joystick forward, drive carefully the first meters too see that the chairs behave as normally.



5.1.4. OPERATING THE ATTENDANT CONTROL (OPTIONAL EXTRA)

Alternatively Balder wheelchairs can be fitted with attendant control and emergency stop, and it can also be provided as a removable model.

Attendant control with emergency stop

Use the panel (1) for the electrical functions such as seat raising, seat tilt and back angle. Push the handles (2) down to move the chair forwards, and lift them up to move it backwards. Pivot the wheelchair by moving the handles (2) to the right or left, also in combination with the driving forwards or backwards. Control the speed by turning the potentiometer (3). Use the rotary switch (4) to select whether the user or the escort is to control the chair. To use the emergency stop simply press the emergency stop switch. Turn the knob to dissolve.



Attendant control

Use the panel (1) for the electrical functions such as seat raising, seat tilt and back angle. Push the handles (2) down to move the chair forwards, and lift them up to move it backwards. Pivot the wheelchair by moving the handles (2) to the right or left, also in combination with the driving forwards or backwards. Control the speed by turning the potentiometer (3). Use the rotary switch (4) to select whether the user or the escort is to control the chair.



5.1.5. DRIVING DISTANCE

Mileage given, may in some cases differ from product to product. Baldertech measures driving length in a uniform manner, but differences may still occur. The values in application areas are intended to ISO standard 7176. Part 4: Theoretical mileage According to the wheelchair's energy consumption. Maximum values specified can be reduced by one or more of the following factors:

- Overall total weight or user weight too high
- Old or worn out battery
- Uneven road surfaces with different friction
- Incorrect inflation pressure in one or more tires, if pneumatic tires are fitted
- The wheelchair is frequently started and stopped
- Extremely hot or cold environments
- Use of motorized accessories

5.2. General seat functions



DANGER

Due to the complex structure of the chair, there may be a risk of getting fingers, etc. caught in the chair in the event of unintentional use.

5.2.1. SEAT TILT

Using the seat tilt function allows the user to adjust the angle of the entire seat unit; i.e. the back and seat will remain at the same angle to one another.

Dolphin joystick

1. Press the seat tilt button.
2. Move the joystick forwards and back to change the angle of the seat unit.



Joystick G90

1. Scroll through to the seat functions using the ASK button.
2. Move the joystick to the right or left until the symbol shows on the display.
3. Move the joystick forwards and back to change the angle of the seat unit.



DANGER

Tilt function forward from horizontal position must only be used indoors and on a flat surface.

5.2.2. SEAT BACK

You change the angle of the back using the seat back function.

Dolphin joystick

1. Press the seat back angle button.
2. Move the joystick forwards and back to change the angle of the back.





Joystick G90

1. Scroll through to the seat functions using the ASK button.
2. Move the joystick to the right or left until the symbol shows on the display.
3. Move the joystick forwards and back to change the angle of the back.





5.2.3. LEFT FOOTREST / LENGTH COMPENSATION

The Balder wheelchairs are available with different types of footrest. The function which the left footrest button operates will therefore depend on which footrest is supplied with your chair.

Dolphin joystick		Joystick G90
<ol style="list-style-type: none"> 1. Press the left footrest button. 2. Move the joystick forwards and back to change the position of the left footrest. 		<ol style="list-style-type: none"> 1. Scroll through to the seat functions using the ASK button. 2. Move the joystick to the right or left until the symbol shows in the display. 3. Move the joystick forwards and back to change the position of the left footrest.  



5.2.4. RIGHT FOOTREST / FOOTREST ANGLE

The Balder wheelchairs are available with different types of footrest. The function which the right footrest button operates will therefore depend on which footrest is supplied with your chair.

Dolphin joystick		Joystick G90
<ol style="list-style-type: none"> 1. Press the right footrest button. 2. Move the joystick forwards and back to change the position of the right footrest. 		<ol style="list-style-type: none"> 1. Scroll through to the seat functions using the ASK button. 2. Move the joystick to the right or left until the symbol shows in the display. 3. Move the joystick forwards and back to change the position of the left footrest.  

5.2.5. SEAT RAISE

You change the height of the seat using the seat raise function.

Dolphin joystick		Joystick G90
<ol style="list-style-type: none"> 1. Press the seat raise button. 2. Move the joystick forwards and back to raise and lower the seat. 		<ol style="list-style-type: none"> 1. Scroll through to the seat functions using the ASK button. 2. Move the joystick to the right or left until the symbol shows on the display. 3. Move the joystick forwards and back to raise and lower the seat.  

5.3. Stand up function

Balder Finesse and Balder Junior are available with a stand up function. Read this section if it is applicable to your wheelchair.



DANGER

When in standing position, the wheelchair must only be used indoors and on a flat surface.

NOTE

The starting position is the position to which the chair will return when you switch back from standing position.

NOTE

It is important to adjust the footrest into the correct position before switching to standing position, as this function will not be available once the chair is in this position.

NOTE

If you use the stand up function from horizontal position, the abduction pad must not be put on until the legs are in the horizontal position.

NOTE

When the support legs are activated, the stand up function will stop for a moment to wait for the support legs to move into the correct position. If the support legs cannot be activated automatically, a green light will flash on the stand up function panel. In this instance, return to the starting position, move the chair slightly and try again.

NOTE

In standing position, only the back will be adjustable, to a restricted extent. The footrest, raise and tilt functions are disabled for safety reasons while the chair is in the upright position.

NOTE

The chair can be programmed so that the back cannot be operated or adjusted while the chair is in standing position.

NOTE

The fixings for the stand up function, knee brace cushion and chest belt, do not replace a safety belt in a car. Ensure correct fixing for use of the stand up function.

The stand up function

1. Move the seat and back to the required starting position (cf. sections 5.2.1 and 5.2.2)
2. Move the footrest to the required starting position (cf. sections 5.2.3 and 5.2.4)
3. Activate the seat raise function (cf. section 5.2.5).
4. Raise the seat until you are at the correct height. The correct height is indicated by a yellow light which comes on in the vertical function panel (1).
5. Push the lower part of the lock pin up, so that it sticks straight out (2a). Thread the buckle of the knee brace cushion into the fixing bracket. Push the lock pin back, so that it remains straight up, with the broadest part of the lock pin facing down. The lock pin is now in the lock position, and the knee brace cushion is ready for use of the stand up function (2b). The knee brace cushion must be tight below the knee.
6. Put on the breast belt (3) and tighten it
7. Activate the stand up function by holding down the stand up function switch (4).
8. Move the chair to the upright position, the support legs (5) will automatically be lowered when the seat angle exceeds 15 degrees. A green light (6) comes on when the support legs are activated.

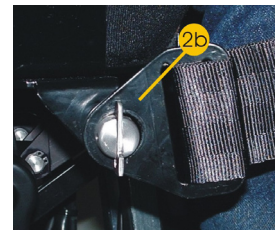

Return to the starting position

1. Press and hold down the switch (7) to deactivate the standing position and return to the starting position.

5.4. Interference

NOTE

When the chair is activated, it may affect electrical equipment which contains radio transmitters/receivers.

If the chair stops, check the automatic fuse as described in section 5.4.1. If you need to push the chair, the chair can be disconnected as described in section 5.4.2.

See also section 9, or contact your dealer if you require assistance.



DANGER

Do not use any other devices in combination with the power chair. Ex. charging the batteries, mobile, laptop etc.

5.4.1. CHECKING THE AUTOMATIC FUSE

The main circuit switch/fuse is located behind a cover at the right side of the chassis. It is marked with circuit switch/main fuse and a voltage symbol. By sliding the cover (see picture) you will have access to the fuse/breaker.

Junior and Finesse

Push the lever up to engage. Press the switch to disconnect.



5.4.2. DISCONNECTING THE BREAKS/DRIVE MOTOR



DANGER

The chair must not be disconnected on slope, as this may cause it to roll away!

NOTE

The chair should be switched off when disconnecting the breaks/drive motors.

If you need to move the chair without using the electronics, the breaks/drive motors have to be disconnected.

Junior and Finesse

The disconnection switches are located at the front of the wheelchair.



Disconnect: Move the two switches (1) down until they lock in position.

Connect for operation: Move the two switches (1) up until they lock in position.



WARNING

Do not leave the wheelchair in unlocked position with the occupant seated.

6. TRANSPORT OF WHEELCHAIR AND USER IN CAR



DANGER

Ensure that the vehicle is suitably equipped to transport a passenger in a wheelchair, and ensure the method of access /egress is suitable for your wheelchair type.

The vehicle should have the floor strength to take the combined weight of the occupant, the wheelchair and accessories.

The wheelchair should be secured in a forward facing direction. This wheelchair is tested to ISO 7176-19, for use in road vehicles and meets the requirements for forward facing transport and head on collisions. The wheelchair has not been tested for other directions in a vehicle

NOTE

Use WTORS in accordance with the WTORS manufacturers instruction.

Terminology explained: WTORS = Wheelchair Tie-down Occupant Restraint System used in the ISO standards 7176-19 and 10542. and is defined as a complete system consisting of equipment for securing the wheelchair and seat belt for the user. The WTORS abbreviation will be used in this guide.



DANGER

The wheelchair can only be secured by using the tie-down points on the wheelchair's frame

The tie-down points (2 in the front, 2 in the back) are indicated by the tie-down symbol.

The wheelchair may not be secured onto any accessories (wishbones, armrests, anti-tip brackets etc.).

No changes or replacements must be made to the anchorage points/car fastenings on the wheelchair for docking system or 4 point strap tie down systems, or to constructional elements or parts of the frame without consulting the manufacturer.

There are attachments on the wheelchair – 2 in front (1) and 1 ring (2) at the rear. These are indicated by means of symbols as shown in the illustration.

In Front



Back



6.1. General occupant restraint Instructions

- Use a 3-point occupant restraint system to secure the occupant.
- Both pelvic and upper torso restraint belts must be used to restrain the occupant to reduce the possibility of head and chest impacts with the vehicle components.
- Occupant restraints should be mounted to the appropriate vehicle pillar.
- Use a suitable positioned headrest when being transported in a wheelchair.
- Wheelchair anchored postural supports (lap straps, lap belts) should not be used or relied on for occupant restraint in a moving vehicle.
- Occupant restraints should make full contact with the shoulder, chest and pelvis and pelvic belts should be positioned low on the pelvis near the thigh-abdominal junction (meeting the requirements specified in ISO 7176-19:2008).
- The upper torso restraint belt must fit over the midpoint of shoulder and across the chest as illustrated
- Restraint belts must be adjusted as tightly as possible consistent with user comfort.
- Restraint belt webbing must not be twisted when in use.
- Care should be taken when applying the occupant restraint to position the seatbelt buckle so that the release button will not be contacted by wheelchair components while driving or during a crash.
- Belt restraints must not be held away from the body by wheelchair components such as armrests or wheels.



BELT RESTRAINT MUST NOT BE HELD AWAY FROM THE BODY BY WHEELCHAIR COMPONENTS SUCH AS ARMRESTS OR WHEELS.

BELT RESTRAINTS SHOULD MAKE FULL CONTACT WITH THE SHOULDER, CHEST AND PELVIS AND PELVIS BELTS SHOULD BE POSITIONED LOW ON THE PELVIS NEAR THE THIGH-ABDOMINAL JUNCTION.

Illustration of improper belt-restraint fit



Illustration of proper belt-restraint fit

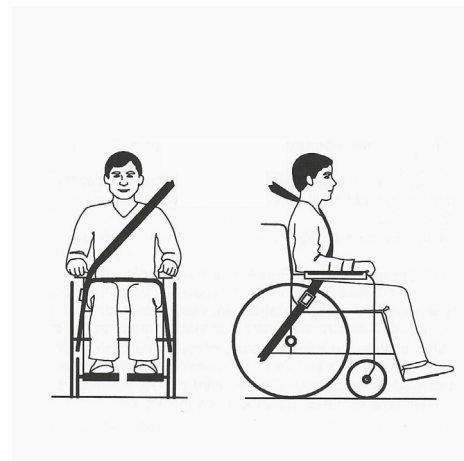

6.2. Securing the chair in a car with a 4 point strap tie-down system



DANGER

Always make sure your chair is secured when you transport it. Always ensure that the attaching equipment you are using is approved for transporting your chair in a car. To secure your chair during transportation, the fixing rings on the chair must be used as the attachment points for straps.

NOTE

The illustrations show the Q-strait strap system.

Manual straps

1. Attach and tighten the front straps (1) to the attachment points at the front of the wheelchair. There is one strap on either side. This is done when the chair is in the correct position.
2. Attach and tighten the rear straps (2) to the fixing ring (3) at the back of the wheelchair.
3. Check that the straps are tightened properly so that the chair does not move about.
4. Push down the locking catch to lock the chair in this position.

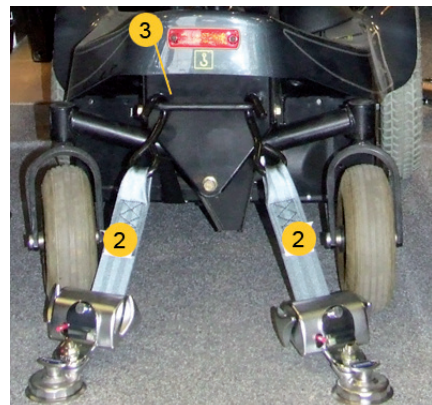
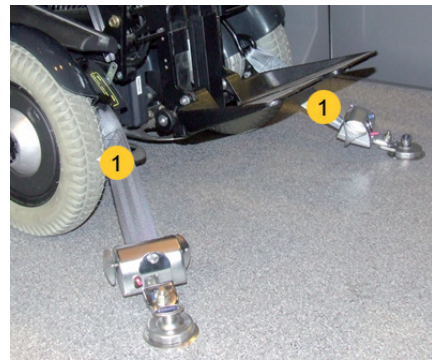

DANGER

When fitted, tie-down straps angles should fall within the preferred angles shown below.

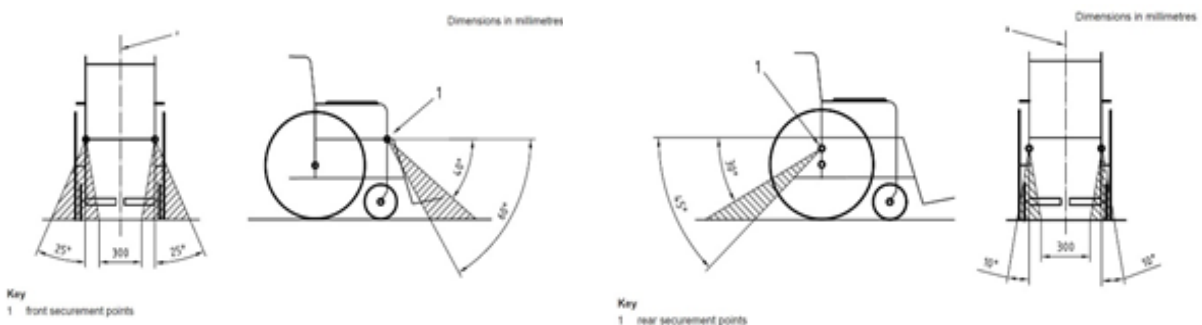

Preferred angles for front tie-down straps

Preferred angles for rear tie-down straps



DANGER

Positioning the occupant restraint when using it with a 4 point strap tie-down system:

The pelvic restraint belt must be worn low across the front of the pelvis so that the angle of the pelvic belt is within the optional or preferred zone of 30° to 75° to the horizontal. A steeper (greater) angle within the preferred zone, 45° to 75° is desirable i.e. closer to, but never exceeding 75° degrees.

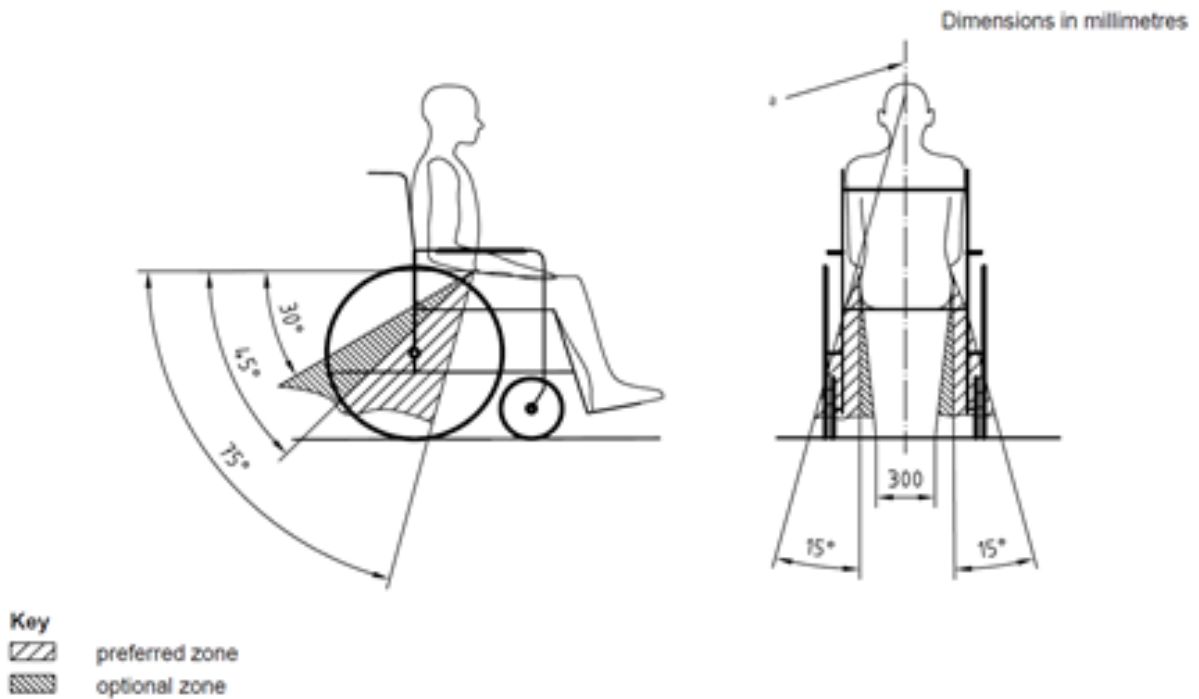

Preferred and optional angles for location of the lap belt

6.3. Using a docking system (optional extra)



DANGER

The clamp down unit must be fitted by an approved installer and adjusted to suit the wheelchair in accordance with the description of fitting.



WARNING

Do not move the vehicle:

- Whilst the wheelchair is being maneuvered into position in the docking station.
- If the wheelchair and user are not correctly secured.
- If there are indications that the clamp down is not functioning normally.
- Before the user's seat belt is secured and tightened.

6.3.1. DAHL DOCKING SYSTEM

Compatible with Docking Station MKII and VarioDock, see fitting instructions for more details.



WARNING

Do not move vehicles until the wheelchair is in the correct position, this is indicated by a green light in the control panel of the car.

NOTE

Always check if the lock plate is properly engaged in the docking station by trying to reverse the wheel chair out of the docking station before moving the vehicle. (It must not be possible to reverse out of the docking station without pressing the red release button in the control panel).

Attaching the chair to the docking station

1. Manoeuvre the wheelchair slowly and in a uniform direction over the docking station (1). The lock plate (2) under the wheelchair helps to guide the wheelchair into place in the docking station. When the lock plate is fully engaged in the docking station, a spring-action locking pin (3) automatically secures the lock plate.
2. The docking station is equipped with a control switch that indicates whether the lock plate is correctly secured in the docking station. As soon as the lock plate comes into contact with the locking pin, a warning tone will sound (a high-pitched howl), and the red lamp (4) in the control panel will light up until the lock plate is either fully engaged or else the wheelchair is removed from the docking station.
3. As an indication that the wheelchair is properly secured, the warning tone will cease, the red lamp in the control panel will go out and the green lamp (5) will light up.



Removing the chair from the docking station

1. To unlock commence by driving the wheelchair forward to release pressure on the lock pin.
2. Press the red release button (6) in the control panel. The locking pin will be triggered/ released for approx. 5 seconds, after which the locking pin is automatically locked/ activated again.
3. Move the wheelchair away from the docking station within this 5-second period. Do not attempt to reverse out of the docking station until the red lamp on the control module, which indicate the unlock position, has been illuminated.



WARNING

Attempting to reverse the wheelchair before the red LED has been illuminated will result in blocking the docking stations locking mechanism, which makes it impossible to reverse. If this happens repeat above unlocking procedure.

NOTE

Manual release in case of electric failure:

A manual emergency release (1) is located at the front edge of the docking station.

1. Move wheelchair forward to remove the pressure on the lock pin and push the red release arm to one side and hold it there while the wheelchair moves away.
2. A cable-activated manual operating lever can also be fitted (accessory). The red release arm is also pushed to one side and should be held there whilst the wheelchair moves away.



NOTE

If the described manual release procedures fails, an emergency release tool made from red plastic comes with each docking station. this is operated like this:

1. Move wheelchair forward to remove the pressure on the lock pin.
2. Place the emergency release tool in the gap between the locking plate and the docking station.
3. Push the release tool and wheelchair forward until the locking pin has been forced down - after which the wheelchair can reverse out of the docking station.

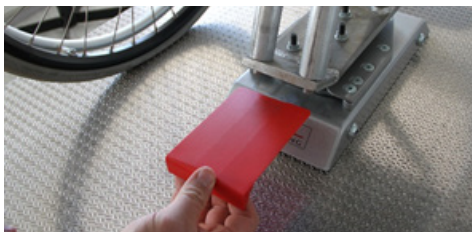

DANGER

Positioning the occupant restraint when using it with the Dahl Docking systems:

When using wheelchair with Dahl Docking systems, the floor anchorage points for the occupant restraint system should be located 10-60 mm outside wheels, on each side. The pelvic belt must be worn low across the front of the pelvis so that the angle of the pelvic belt is within the optional or preferred zone of 30° to 75° as shown. A steeper (greater) angle within the preferred zone, 45° to 75° is desirable i.e. closer to, but never exceeding 75° degrees.

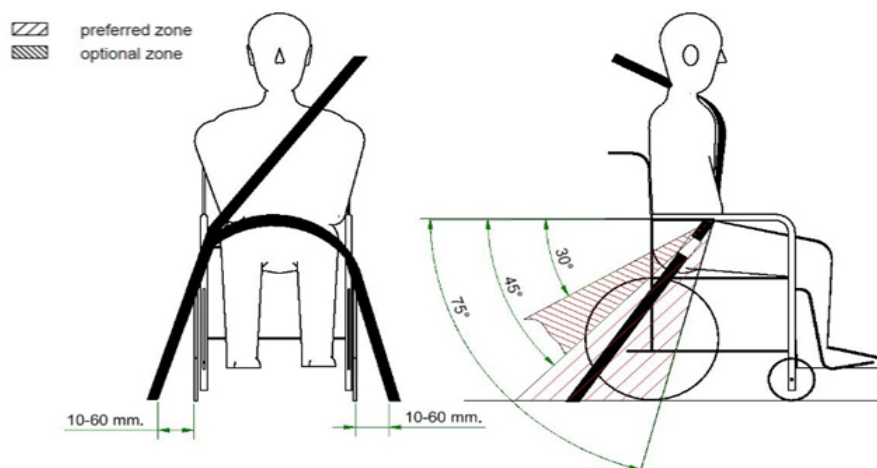

Preferred and optional angles for location of the lap belt

6.3.2. BALDER DOCKING SYSTEM



WARNING

Do not move vehicles until the wheelchair is in the correct position, this is indicated by a green light in the control panel on the chair.

NOTE

If you fail to get out of the clamp down unit, a flashing red light will be displayed for 90 seconds after five attempts and the clamp down unit will remain inactive for this period in order to prevent the release solenoid overheating. The clamp down unit will be ready for use again after 90 seconds.

NOTE

There is a manual release. It is located down at the back of the chair, push the lever down while releasing the chair using the joystick or do it manually.

Attaching the chair to the docking station

1. Roll the chair into the docking station (1).
2. When the chair is in the correct position, a green light (2) will appear in the car bracket panel.

Removing the chair from the docking station

1. To remove the chair, hold down the switch (4) on the switch panel until a green light starts flashing (2).
2. Move your hand to the joystick. A red light comes on when the chair is released (3).
3. Remove the chair from the docking station within three seconds. The indicator lamp (2) goes out once the character is free of the docking station



NOTE

If you do not remove the chair from the docking station within three seconds, or if you decide not to remove the chair, the chair will be locked back into the car bracket and the green light (2) will come on if the chair is in the correct position.

Repeat the process if necessary.

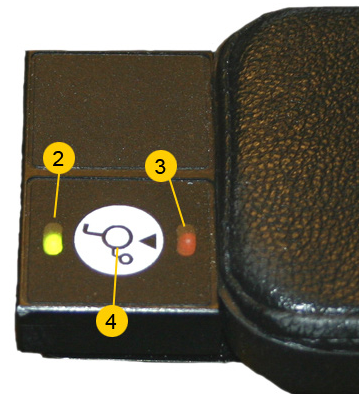



DANGER

Positioning the occupant restraint when using it with the Balder clamp down:

The floor anchorage points for the occupant restraint system should be located 10-60 mm outside wheels, on each side. The pelvic belt must be worn low across the front of the pelvis so that the angle of the pelvic belt is within the optional or preferred zone of 30° to 75° as shown. A steeper (greater) angle within the preferred zone, 45° to 75° is desirable i.e. closer to, but never exceeding 75° degrees.

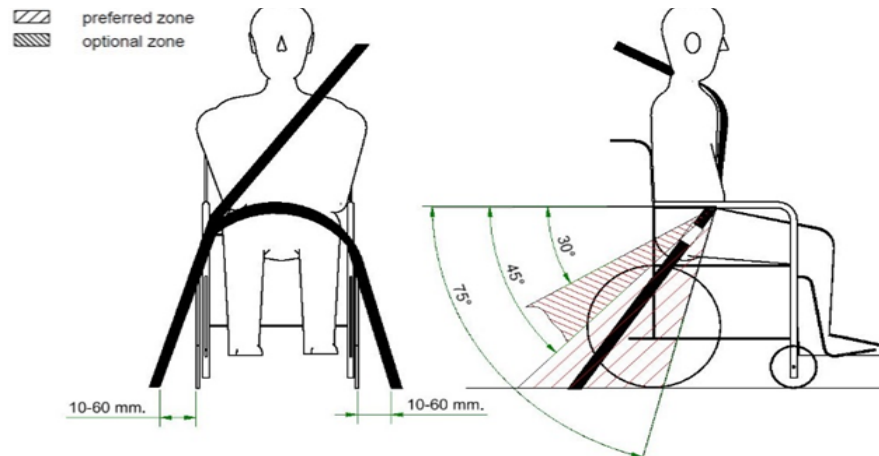

Preferred and optional angles for location of the lap belt

6.4. Transportation by air

NOTE

Balder wheelchairs are supplied in many specially adapted variants, so equipment may be fitted which has to be removed in addition to what is described here.

Balder wheelchairs are supplied as standard ex works with Sonnenschein dryfit gel batteries. These batteries are approved in accordance with IATA Dangerous Goods Regulations – Packing Instructions 806 and Special provision A67. The batteries must be labeled with IATA labels. This means that the batteries are approved for transportation by air. If a situation nevertheless occurs in which it is necessary to physically disconnect the power supply from the battery poles, see section 8.2.5 on battery removal.

6.4.1. PREPARATIONS PRIOR TO TRANSPORTATION BY AIR

You have to make a few preparations prior to removing items in order to ensure that the chair takes up as little physical space as possible while being transported.

1. Use the electrical functions on the control panel and move the electric seat tilt so that the seat pad is more or less horizontal.
2. Move the electric back up to approx. 110 degrees to the seat pad.
3. Move the electric footrests upwards and inwards as far as possible without them catching on the floor.
4. Move the electric seat raise as far down as possible.
5. Switch off the electrical functions using the on/off button on the control panel.

See “Use and Transport” at www.baldertech.com for further information.

7. STORAGE



WARNING

Never leave the batteries standing for a long time fully discharged. If the chair is to be stored for a period of time, the batteries must be fully charged once a month.

Your Balder wheelchair must be kept dry, protected from the elements and preferably kept indoors. If you store your chair for any length of time without it being used, the batteries must be disconnected.

8. MAINTENANCE

8.1. Maintenance – Overview

Activity	Frequency
Battery charging	8 hours a day
Recommended service interval	After every 2500 hours of use / once a year / as required
Frame and body cleaning	As required
Seat cleaning	As required

8.2. Maintenance procedures

8.2.1. BATTERY CHARGING



WARNING

Never leave the batteries standing for a long time fully discharged. If the chair is to be stored for a period of time, the batteries must be fully charged once a month.

Do not leave the charger connected to the wheelchair if the power cable is not connected to the mains as this will cause the batteries to gradually become discharged.

NOTE

To ensure top performance from the batteries, we recommend that the chair be charged for eight hours a day. If this is not possible, you must ensure that the chair is fully charged at least once a week.

NOTE

We recommend that batteries to be discarded should be handed to a specialist center in order to ensure that they are disposed of correctly.

NOTE

Only use the charger belonging to your wheelchair, and follow the user guide for the charger as regards how the batteries are to be charged. The charging point is the same for both types of joystick (Dolphin and Europa).

NOTE

There is no risk involved in leaving the charger connected to the wheelchair as long as the power is switched on. This will ensure that the batteries are charged fully and will maintain their charge.

NOTE

With two red diodes at the battery indicator, the driving distance left is approx. 2 km. To avoid battery damage, recharge the wheelchair when the indicator shows one red flashing led.

NOTE

No parts is to be repair by the intendent user.

When the batteries are to be charged

1. Check that the chair is switched off.
2. Connect the charger cable to the charger contact (1)
3. Connect the power supply cable to the mains.



When the batteries are fully charged

1. Disconnect the charger from the mains.
 2. Disconnect the charger from the wheelchair (1)
-

8.2.2. FRAME AND BODY CLEANING

The chair is cleaned using mild soapy water as required.

8.2.3. SEAT CLEANING

Cleaned as required; cf. the cleaning instructions sewn onto the seat pads.

8.2.4. RELEASING THE SEAT

If the power to the chair is switched off and you need to remove the chair body, the seat lift function can be released manually.

1. Pull the lock pin (1) out to the side, and a gas spring on the lifting arm will raise the seat unit. Bear in mind that this is a strong spring which will react quickly when the lock pin is removed. Place weight on the seat: this will allow the lock pin to be loosened more easily.
2. Remove the cover using six body screws on the main cover which covers all of the lower part of the wheelchair.
3. Lift off the main cover.



8.2.5. DISCONNECTING THE BATTERIES

1. Check that the chair is switched off.
2. Remove the battery shoes and isolate these so that they cannot come into physical contact with the battery poles (see the illustration).
3. Place the battery shoes in the cavity behind the batteries.



To get access to the batteries remove the cover. Release the cover by turn Dsuz against the clock.



Lift of cover. Remove batteries.



8.2.6. FITTING THE BATTERIES

1. Connecting the power: follow the instructions for removal, but in reverse order.
2. Fit the main cover.
3. Press the seat unit down while guiding the seat raise motor into the attachment device.
4. Check that the levers for disconnecting the drive motors are in Operation position. These are marked Operation – Disconnected.
5. Switch on the chair using the on/off switch on the control panel, then check that all the electrical functions work.

8.2.7. TIRE

Your Balder is fitted with either ordinary air-filled tires or puncture-free compact tires. Even with compact tires, it is sensible to ensure that these are not worn or damaged to an unreasonable extent.

To get access to swapping the front tires, first remove the rim cover. This is fastened with two screws.



Release rim that is fastened with six bolts. Change tires. Reassembly the opposite way.



WARNING

Never inflate tires above the maximum pressure specified below. It is safer to pump up the tires of the wheelchair with a manual pump. Control the pneumatic pressure using a standard pressure gauge for cars.

If your chair is fitted with air-filled tires and you happen to sustain a puncture, contact authorized personnel. Avoid traveling in the chair when it has a punctured tire.

See technical specifications, section 2.1.3

If a Balder wheelchair is equipped with air filled tiers, please pay tension to the air pressure:
206,84 kPa on drive wheel.
344,74 kPa on caster wheel.

The valve is placed inside the rim.



9. TROUBLESHOOTING

1	What do you do when the chair is completely dead?	<ul style="list-style-type: none"> • The chair is unpowered. • Fault in the electronics. • Fault in the electrics. 	<ul style="list-style-type: none"> • Remove the charge contact. • Check that the on/off switch is set to On. • Check that the magnetic key is not activated. • Check that the switches for disconnecting the motor are in "Operation" position.
2	The chair can be moved but none of the electrical functions are working?.	<ul style="list-style-type: none"> • Fault in the electrics. 	<ul style="list-style-type: none"> • Contact your dealer.
3	The chair will not accept a charge.	<ul style="list-style-type: none"> • Fault in the charger. • Poor contact in the charge contracts / cable. • Fault in the electronics. • Defective batteries. 	<ul style="list-style-type: none"> • Plug in the chair. • Make sure that the indicator lamp on the charger is on. • If the indicator on the charger is not on, there is a fault in the charger. • Contact your dealer.
4	The chair's indicator lamp flashes once, with two seconds' gap between flashes.	<ul style="list-style-type: none"> • The joystick has to be purged of data for the rest of the system. 	<ul style="list-style-type: none"> • Leave the chair on for 10 seconds, switch it off for 10 seconds, then switch it on again. The chair should be ready for operation.
5	The chair's indicator lamp flashes twice, with two seconds' gap between flashes.	<ul style="list-style-type: none"> • The speed limited for the seat lift has been activated. • Fault in the electronics. 	<ul style="list-style-type: none"> • Not a fault. Lower the seat height until it is below the speed reduction limit. • Contact your dealer.
6	The chair's indicator lamp flashes several times, with two seconds' gap between flashes.	<ul style="list-style-type: none"> • Fault in the joystick. • Fault in the electronics. • Fault in the cable. 	<ul style="list-style-type: none"> • Count the number of flashes, then contact your dealer.
7	The chair is difficult to move.	<ul style="list-style-type: none"> • Incorrect operating program. • Incorrectly adjusted program. 	<ul style="list-style-type: none"> • Select a different operating program. • Contact your dealer.
8	The speed of the chair is suddenly halved while it is moving.	<ul style="list-style-type: none"> • Seat position too high. • Fault in the speed limiter. 	<ul style="list-style-type: none"> • Check the seat height as the chair is fitted with speed reduction.
9	Electric back function and electric tilt move forwards only.	<ul style="list-style-type: none"> • Not a fault. • Fault in the limiter switches and/or diodes. 	<ul style="list-style-type: none"> • Raise the seat so that the limiter switches are not enabled. • Contact your dealer.
10	A part seems loose.	<ul style="list-style-type: none"> • Not tightened enough. • Threads stripped. • Incorrect assembly • Impact or vibration damage. 	<ul style="list-style-type: none"> • Check fitting or tightening. • Tighten loose screws. • If you are not sure what is wrong or how you should fix it, contact your service partner.
11	Lift, tilt or back function moves in one direction only	<ul style="list-style-type: none"> • Fault on the tilt switch • Fault in the electronics. • Trap guard activated if this is mounted on your chair. 	<ul style="list-style-type: none"> • Check whether there are any foreign bodies in the cover, and remove these. • Contact your dealer.

These points are intended to provide simple guidance. Contact your dealer for further assistance.

10. OPTIONAL EXTRAS

Below is a list of some of the optional extras available for Balder electric wheelchairs.

Item
Bag with the Balder logo, black
Bag with the Balder logo, small, black
Fixing bar for ruck-sack/bag F Fixing bar for ruck-sack/bag Junior Kneepads, removable (set), F
Thigh supports, removable (set), F
Support pads, knees/thighs, Balder Junior, 6x11 cm Support pads, knees/thighs, Balder Junior, 6x20 cm Support pads, back, Balder F, Comfort 1-3
Support pads, back, Balder F, Comfort 4-6
Support pads, back, Balder Junior, 6x11 cm
Attendant control 2
Attendant control with emergency stop function
Separate switch panel with all functions

This information is subject to change without warning and must not be perceived as constituting obligations on the part of Baldertech AS. Baldertech AS undertakes no responsibility for any errors which may appear in this document. The content of this document is to be regarded as the property of Baldertech AS and must not be used in a commercial context without the permission of Baldertech AS.

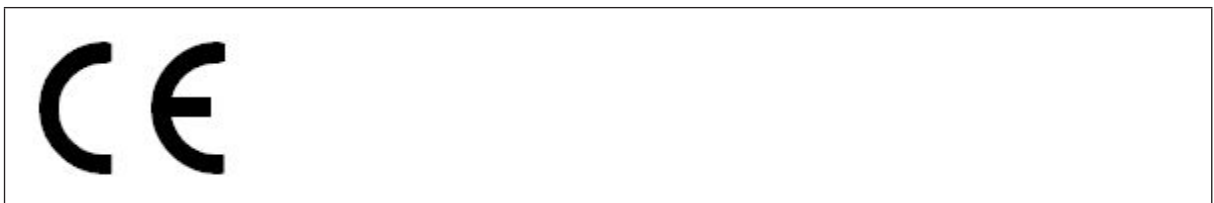

11. CONTACTS

Baldertech Ltd

Roentgen Road
Basingstoke
Hampshire RG24 8NG
Email : uksales@baldertech.com
Telephone : +44 12 56 76 71 81
www.balder.uk

Baldertech AS

Email : info@baldertech.com
Telephone : +47 32 11 11 00
www.baldertech.com

Label serial number

Baldertech AS
Email : info@baldertech.com
Telephone : +47 32 11 11 00
www.baldertech.com

baldertech