

This system conforms to ISO 10542-1:2012 and is suitable for wheelchairs with a mass of 200 kg + user.

SECURING WHEELCHAIR

Recommendations for Clear Zones on page 2.

- Drive wheelchair into position facing forward. Be aware of Frontal Clear Zones. Lock wheelchair brakes or switch off the power to the electric wheelchair.
- Anchor the four retractors into the floor pockets (see 1 & 2). Be aware of a distance of 115-145cm between the front and rear retractors when using rails. Please also see page 2 for further information.
- Push the overcenter buckle down until you hear a clicking sound and the buckle is engaged (see C).
- For length adjustment and tightening pull at the loose end of the strap (see C).

SECURING PASSENGER

- Pull the shoulder belt over the occupant's chest and hip and insert the seat belt tongue into both seat belt buckles (see 3, and illustration B).
- Adjust shoulder belt height so that the belt rests on the shoulder (see 4).
- Belts should be adjusted as firmly as possible, consistent with user comfort.

RELEASING PASSENGER

- Unbuckle the seat belt on both sides of the wheelchair.

RELEASING WHEELCHAIR

- Press on the button (see D) to open the overcenter buckle, in order to slacken the webbing and detach hooks from wheelchair.
- Remove all retractors from the floor anchorage and store safely.
- Unlock wheelchair brakes or switch power on electrical wheelchair.

Wheelchair and user must be placed facing forward in the vehicle!

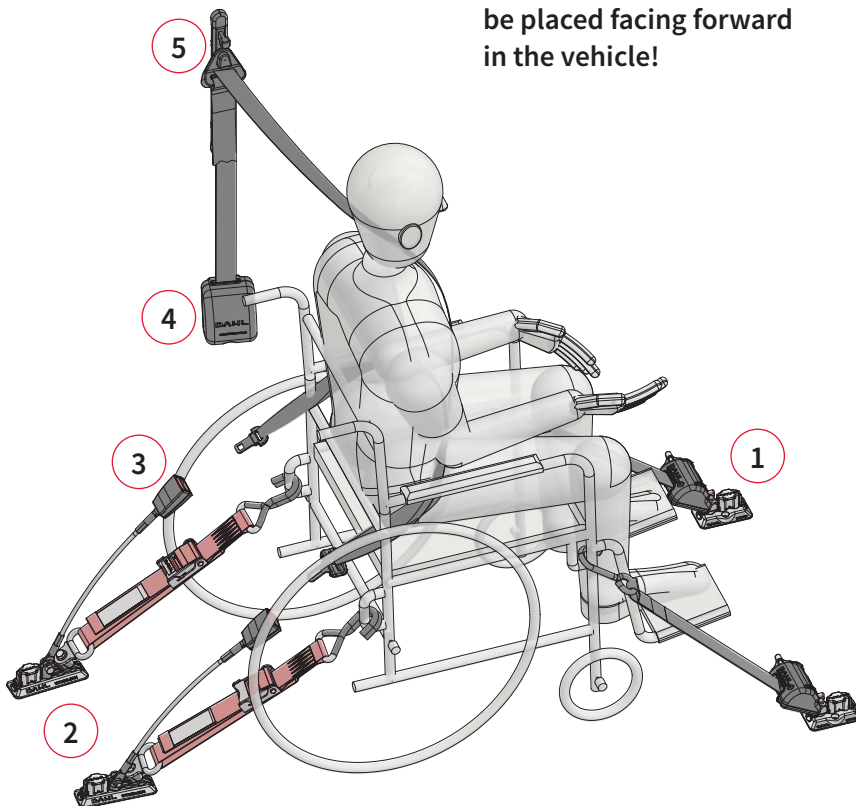

- 1: Attach two front tie-down straps to wheelchair frame/anchorage points. Attach rail fittings in floor pockets (A).
- 2: Attach the two rear tie-down straps to wheelchair frame/anchorage points. The hook openings shall be facing outward. Attach rail fittings in floor pockets (A).
- 3: Attach the tongues from the 3 point occupant restraint to the seat belt buckles placed on the rear tie down straps (B).
- 4: Adjust the height of the diagonal belt to suit the height of the user.
- 5: Hang up seat belt end tongue on plastic hook - to keep excess webbing of the ground when not in use.

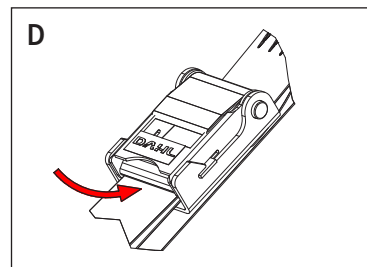
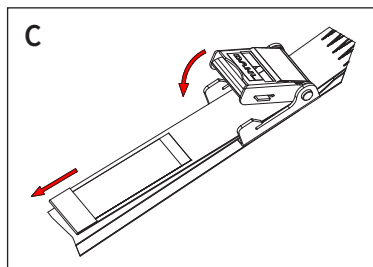
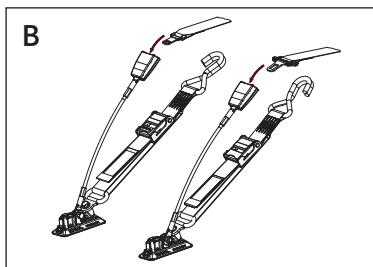
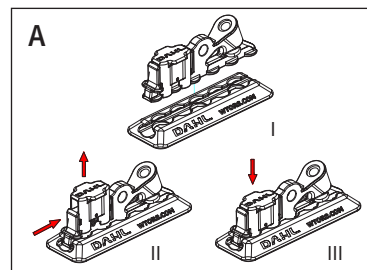

MAINTENANCE & CARE

- Belt webbing should not be worn or twisted and must be protected against contact with sharp edges and corners.
- Safety belts must be inspected and cleaned regularly. Replace belts or straps that have faded in the sun, are worn at the edges, have tears or show clear signs of wear. Components that are damaged or worn must also be replaced. Avoid soiling the belts with chemicals, polishing agents, oil or, in particular, battery acid.
- Clean the belts by hand with hot water and mild soap. Rinse thoroughly with water and allow to dry in the shade. Do not expose the belts to direct sunlight and never use powerful cleaning agents.
- Only moving metal parts that are not in contact with belt webbing should be lubricated with light oil when necessary and if so, very carefully. Never lubricate inertia reels or other components that are part of the safety belt. Never let the belt webbing come into contact with oil or grease.



Please refer to our separate vehicle specific instructions for installation and use. Please also refer to wheelchair manufacturers instructions for transportation.

! WARNINGS

Make sure to read, understand and follow all these instructions.

- In the event that the instructions and warnings in this guide are not followed, or WTORS installed incorrectly, there is a risk of death or serious injury to the wheelchair user and the other passengers in the vehicle.
- This WTORS **must** only be used with wheelchair **facing forward** in the vehicle and only for one wheelchair and one occupant.
- The 4-point WTORS systems from DAHL comply with the standards and safety regulations EU-framework directive 2007/46, EU-regulation 2018/858, Annex II, Part III, Appendix 3, as well as ISO 10542-1:2012.
- We offer crash-tested systems which have been dynamically tested at 48kmh, 20g, with a surrogate wheelchair with a mass of respectively 85kg, 170kg and 200kg. The fitter is responsible for ensuring that the system used is rated for the weight of the wheelchair and it satisfies all statutory requirements. Contact local/national authorities if there is any doubt in this regard.
- The WTORS systems from DAHL and all its components must be checked and maintained regularly.
- Never begin driving the vehicle whilst a wheelchair is being secured or if the user's safety belt is not secured.
- Never transport users in wheelchairs if certified WTORS are not used.
- The lap belt should make full contact with the front of the body in the area where the pelvis and thighbone meet. Use only Dahl WTORS or e-(ECE), E-(EU) or ISO 10542 certified safety belts for securing occupants of the vehicle. Safety belts must not be held away from the body by wheelchair components or parts such as armrests.
- Do not pass tiedowns or restraints through the wheels of the wheelchair.
- Do not attach components to weak/non-solid components or materials.
- An airbag should be deactivated if the user is situated less than 300 mm from the airbag, or as recommended by the vehicle manufacturer. An airbag should also be deactivated if subsequently installed parts block or have an effect on its inflation/expansion.
- WTORS components, inclusive anchorages, which have been involved in a collision from which the vehicle has had to be towed away, or the airbag has been deployed, must be replaced without separating the components, because they can have obtained invisible damages.
- The user should never try to repair, adjust or modify the WTORS components. Alterations or modifications to the system are strongly discouraged. Any alterations carried out without prior agreement with Dahl Engineering are entirely the responsibility of the fitter and/or the user.
- It is forbidden to combine Dahl WTORS components with those of other manufacturers. Some belt fittings/components will be very obviously incompatible, while others may appear to engage correctly, but might not withstand crash loadings or perform satisfactorily.
- Contact Dahl Engineering or your dealer if there is any doubt concerning the use or installation of the product or if the product has faults or non-conformities.
- Wheelchair integrated postural supports or other types of lap belts or 3-point belts should not be used or relied on for occupant restraint in a moving vehicle. Use the vehicle installed Dahl Seat belt system only!
- Auxiliary wheelchair equipment shall be effectively secured to the wheelchair or removed from the wheelchair and secured in the vehicle during transport, so as not to break free and cause injury to vehicle occupants in an impact.
- Items attached to the wheelchair in front of the wheelchair occupant, other than foot supports, shall be removed whenever possible and secured separately during transportation, in order to reduce the potential for injury to the wheelchair occupant and others in the vehicle.
- Be sure to check national regulations with regard to minimum clear space requirements and access to emergency exists for seats and wheelchairs for the vehicle concerned.

RECOMMENDATIONS FOR USE OF SAFETY BELT

Only use Dahl WTORS or e-(ECE), E-(EU) or ISO 10542 certified safety belts for securing occupants of the vehicle.

Please refer to Dahl Engineering's product catalogue containing WTORS and certified safety belts.

Safety belts must not be held away from the body by wheelchair components or parts such as armrests or wheels.

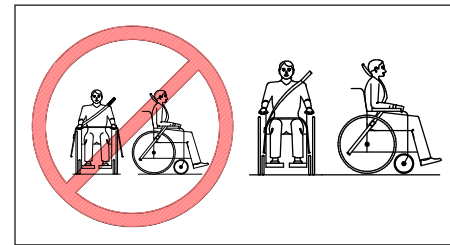

Angles of tie-down straps and locations of tie-down anchor points:

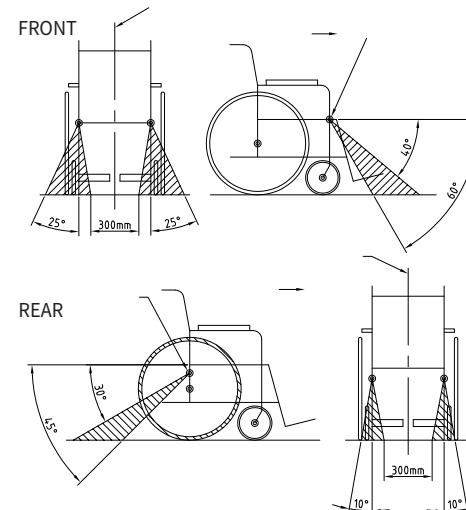

Location of the lap belt:

Preferred and optional angles for location of the lap belt:

▲ = Preferred Zone / ■ = Optional Zone

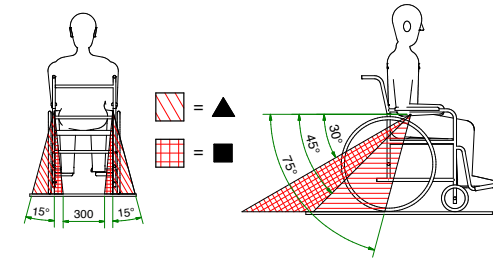

Clear zones:

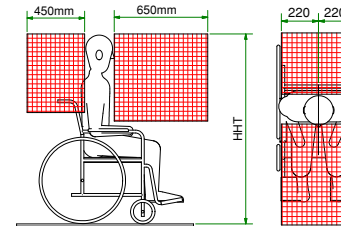

Clear zones are recommended areas in which hard or sharp installation components or objects should not be placed. The clear zone recommendations in ISO 10542 are based on the way in which an occupant moves during a crash/collision. To reduce the risk of injuries to the head and chest, hard vehicle components and parts for WTORS which lie within the clear zones should be covered with padding that meets the requirements with regard to the hardness of materials as specified in FMVSS 201, ECE regulation no. 21 or EU directive 74/60.

Tie-down anchor point location, typical wheelchair width:

